

QST

December, 1938
25 cents

devoted entirely to

amateur radio

In this Issue—

- New Amateur Regulations
- Field Day Results
- Hope on Tank Condenser Spacing

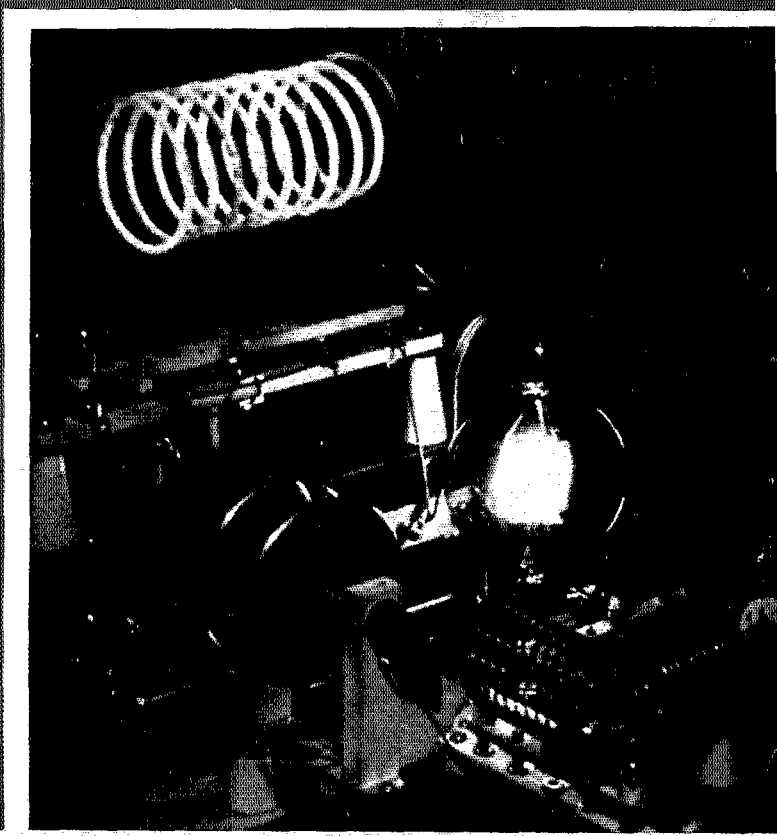

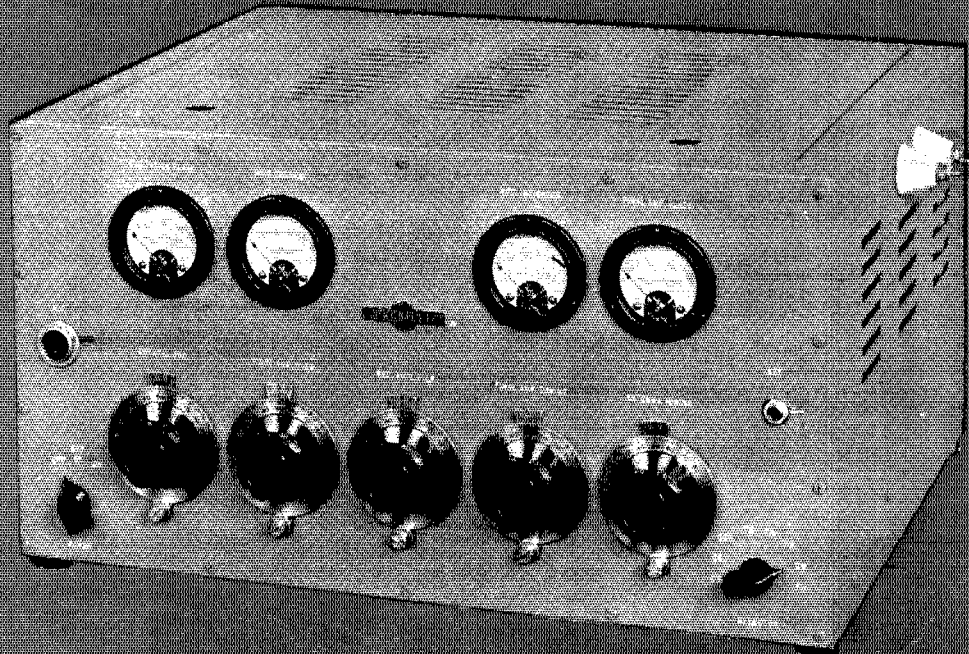

COLLINS 32 G

It has been some time since we have devoted this page to the 32G which continues to be a very popular transmitter, particularly with the discriminating amateur.

The original design of the 32G has been proved by experience to be basically sound. We have studied the set from time to time to see if anything should be changed, but the only modification we found desirable was the substitution of a level indicator calibrated in percent modulation for the oscilloscope. The 32G is another Collins Transmitter which has *performance plus lasting value.*

POWER OUTPUT: 40 watts, radiotelegraph and radiotelephone.

MODULATION: High level class AB. Modulation capability 100%.

AMPLITUDE DISTORTION: Less than 6% at any modulation level.

RADIO FREQUENCY TUBES:
1—C100D, 1—6L6, 1—6L6, 2—6L6.

AUDIO FREQUENCY TUBES:
1—6J7, 1—6C5, 4—6L6.

RECTIFIER TUBES:
3—83V.

AUDIO FREQUENCY RANGE: Plus or minus 1½ db. 50 to 10,000 cycles.

CONTROL CIRCUITS: Switches are provided for switching on each stage progressively for tuning.

ANTENNA TUNING: Collins pi tank matching network.

POWER SOURCE: 110 volt 50/60 cycle.

CABINET DIMENSIONS: Width 20", Depth 16", Height 10½".

We suggest that you listen to some 32G's. They should not be hard to find—hundreds are in use. Write for your bulletin.

COLLINS RADIO COMPANY

GRAND RAPIDS, IOWA

NEW YORK, N. Y.: 11 WEST 40 STREET

The Skyriders preferred around the world for radio communications!

The Super Skyrider S-17



A 13-Tube Super with 2 stages of Pre-Selection, a built-in Noise Limiter, and complete coverage from 62 MC to 545 KC on 6 bands. 1000° of Band Spread. Maximum useable sensitivity and selectivity. Also available with single stage of Pre-Selection and without Noise Limiter.

The Sky Challenger II

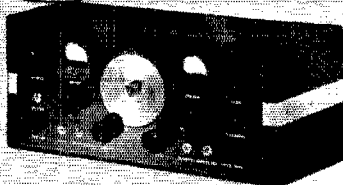

A 9-Tube Super with a tuning range from 38 MC to 545 KC (includes 10 meter band), 1000° Spiral Band Spread and Infinite Image Rejector for the elimination of image interference.

The Sky Buddy

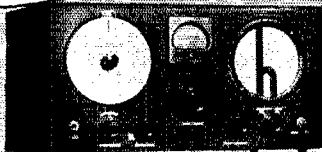

A junior communications receiver with full coverage from 18.5 MC to 545 KC, and all the essential controls for amateur reception. Built-in Speaker, Separate Band Spread Dial. A real amateur receiver at an unusually low price.

In every state of the union, and on every continent of the globe, Skyrider receivers are providing dependable communications reception for amateur and commercial radio stations. The many testimonials received from far off lands are evidence that the Hallicrafters are achieving their purpose—to provide reliable communications receivers with a high standard of performance, built to suit every amateur need.

Because this performance so generally exceeds expectations, a world-wide preference for the Hallicrafter Skyriders has been created, and furthered by the generous praise of their owners.

Your Hallicrafters dealer will gladly show you the Skyrider receivers, or complete description will be forwarded upon direct request to the Hallicrafters Laboratories.

The Sky Champion

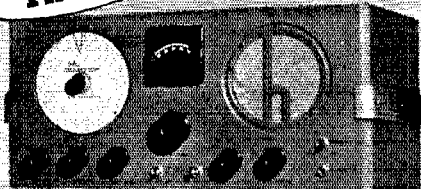

An 8-Tube Super that offers exceptional performance for its modest cost. Provides full coverage from 44 MC to 545 KC (includes 10 meter band) with good sensitivity and selectivity on all bands. Built-in speaker and separate Band Spread Dial.

the hallicrafters inc

2611 Indiana Ave., Chicago, U. S. A.
Cable Address: Hallicraft, Chicago

All Hallicrafters Receivers sold
on liberal Time Payments.

See following page for Skyrider Diversity,
Skyrider 5-10, Skyrider Marine.

WORLD'S LARGEST BUILDERS OF AMATEUR COMMUNICATIONS EQUIPMENT

The Skyriders

receivers for every amateur need
to fit every amateur's purse!

The Skyrider Diversity

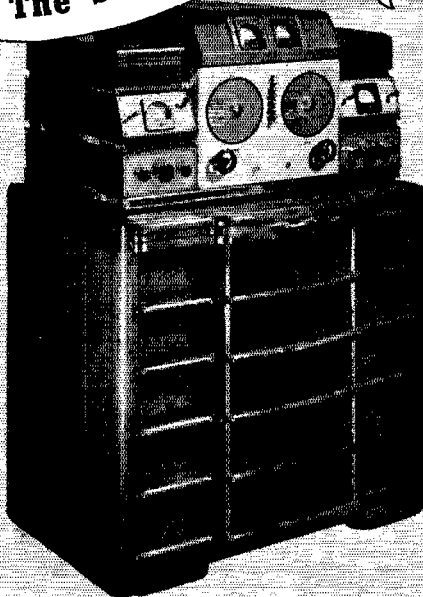

For the first time, Diversity Reception for the amateur! Short-wave reception with fading practically eliminated. Two receivers, each with its own antenna in a different plane, feeding into a common amplifying system, producing a constant signal level, with a stronger signal and lower noise level than any single receiver. Recognized as the highest development in short wave receivers to date, and as opening an entirely new era in short wave reception!

All Hallicrafters Receivers sold on liberal Time Payments.

Regardless of which of the famous Skyrider receivers you might select, whether for a specialized service, as the Skyrider 5-10, or for general reception of the amateur and short wave bands, you can be assured of excellent value. For Hallicrafters receivers, while they represent the most advanced receiver design, and are built with traditional Hallicrafters quality and workmanship, are not high priced. Compare them, feature for feature! Judge their performance! Only then can you appreciate their value!

The Skyrider 5-10

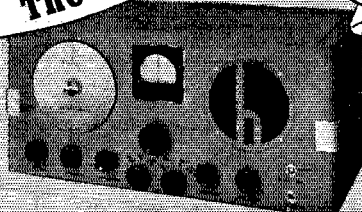

Designed especially for the amateur who wants the exacting performance required for superior ultra high frequency reception.

Tuning Range 27 MC to 68 MC on two bands. 8 Tubes. Built-in speaker. A high order of selectivity makes even the frequency modulated clearly understandable. An excellent receiver for the ultra high frequency specialist.

The Skyrider Marine



An 8-Tube receiver designed especially for the commercial frequencies with especial emphasis on 600 and 700 meter operation. Easily adapted for marine work. Tunes from 16.2 to 2150 meters (18.5 MC to 140 KC) on 4 bands. Built-in speaker. Separate Band Spread.

See preceding page for Super Skyrider, Sky Challenger II, Sky Champion, Sky Buddy.

the hallicrafters inc.

2611 Indiana Ave., Chicago, U. S. A.

Cable Address: Hallicraft, Chicago

WORLD'S LARGEST BUILDERS OF AMATEUR COMMUNICATIONS EQUIPMENT

QST

devoted entirely to

AMATEUR RADIO

PUBLISHED, MONTHLY, AS ITS OFFICIAL ORGAN, BY THE AMERICAN RADIO RELAY LEAGUE, INC., AT WEST HARTFORD, CONN., U. S. A.; OFFICIAL ORGAN OF THE INTERNATIONAL AMATEUR RADIO UNION

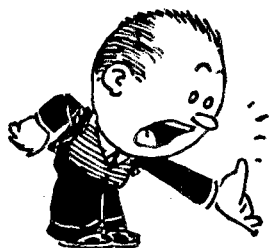

DECEMBER 1938

Volume XXII Number 12



Kenneth B. Warner, *Editor and Business Manager*; Clark C. Rodimon, *Managing Editor*; James J. Lamb, *Technical Editor (on leave of absence)*; George Grammer, *Acting Technical Editor*; Donald H. Mix and Thomas M. Ferrill, Jr., *Technical Assistants*; Vernon Chambers, *Laboratorian*, . . . F. Cheyne Beekley, *Advertising Manager*; Charles Brunelle, *Assistant Advertising Manager*. . . David H. Houghton, *Circulation Manager*; Ralph T. Beaudin, *Assistant Circulation Manager*.

Editorial and Advertising Offices
38 La Salle Road
West Hartford, Connecticut

Subscription rate in United States and Possessions and Canada, \$2.50 per year, postpaid; all other countries, \$3.00 per year, postpaid. Single copies, 25 cents. Foreign remittances should be by international postal or express money order or bank draft negotiable in the U. S. and for an equivalent amount in U. S. funds.

Entered as second-class matter May 29, 1919, at the post office at Hartford, Connecticut, under the Act of March 3, 1879. Acceptance for mailing at special rate of postage provided for in section 1103, Act of October 3, 1917, authorized September 9, 1922. Additional entry at Concord, N. H., authorized February 21, 1929, under the Act of February 28, 1925.

Additional second-class entries to cover sectional editions authorized March 20, 1935. Copyright 1938 by the American Radio Relay League, Inc. Title registered at United States Patent Office.

The Contents

Editorials	9
Circulation Statement	10
Silent Keys	10
Our Cover	10
We Have New Regulations . <i>Kenneth B. Warner, W1EH</i>	11
Hamdom <i>PJ3CO</i>	17
A Simple Transmitter for Portable or Emergency Work <i>Byron Goodman, W1JPE</i>	18
A.R.R.L. Copying Bee — December 9th	20
A Practical Television Receiver for the Amateur <i>C. C. Shumard</i>	21
What the League Is Doing	26
Results, 1938 A.R.R.L. Field Day	28
Full-Range Selectivity with 455-kc. Quartz Crystal Filters <i>D. K. Oram</i>	33
The Philco "Mystery Control"	36
How Much Condenser Spacing? <i>T. M. Ferrill, Jr., W1LJI</i>	37
How Would You Do It?	40
I.A.R.U. News	43
Operating News	44
Correspondence Department	51
A.R.R.L. QSL Bureau	102
Hamads	103
QST's Index of Advertisers	106
Index to Volume XXII	109



39 EDITION OF THE
**AMATEUR'S
BOOK**

IS READY!

\$1 POSTPAID
\$1.25 OUTSIDE OF
CONTINENTAL U.S.A.

Section Communications Managers of the A.R.R.L. Communications Department

All appointments in the League's field organization are made by the proper S.C.M., elected by members in each Section listed. Mail your S.C.M. (on the 16th of each month) a postal covering your radio activities for the previous 30 days. Tell him your DX plans for experimenting, results in phone and traffic. He is interested, whether you are an A.R.R.L. member or get your QST at the newsstands; he wants a report from every active ham. If interested and qualified for O.R.S., O.P.S. or other appointments he can tell you about them, too.

Eastern Pennsylvania Maryland-Delaware-District of Columbia Southern New Jersey Western New York Western Pennsylvania	W3QP W3BAK W3BEL W3CSE W8QFO	ATLANTIC DIVISION John B. Morgan Edgar L. Hudson W. W. Pitson Ed Preston Kendall Speer, Jr.	Blue Bell Laurel, Delaware Audubon Tully Lowber
Illinois Indiana Kentucky Michigan Ohio Wisconsin	W9RMM W9QG W9ARU W8DPE W8AQ W9UIT	CENTRAL DIVISION Leslie M. Dickson Noble Burkhardt Darrell A. Downard Harold C. Bird E. H. Gibbs Aldrich C. Krones	Edellyn Farms R. 4, Box 1 116 N. Longworth Ave. R.F.D. 2 405 Broad St. 3127-A West Madison St.
North Dakota South Dakota Northern Minnesota Southern Minnesota	W9RZA W9VOID W9IGZ W9YNG	DAKOTA DIVISION Ernest Bloch Dr. A. L. Russell Edwin L. Wicklund Millard L. Bender	Box 202 R.F.D. 3 608 N. Huron Ave.
Arkansas Louisiana Mississippi* Tennessee	W5ABI W5DKR W5GHP W4DWS	DELTA DIVISION H. E. Veite Eugene H. Treadaway Robert E. Barr William Harold Walker	4415 West 12th St. 2749 Myrtle St. 301 Boscobel
Eastern New York N. Y. C. & Long Island Northern New Jersey	W2LU W2AZV W2GMN	HUDSON DIVISION Robert E. Haight E. L. Baunach Fred C. Read	511 South Holmes St. 102 Central Ave. 1014 North Ave.
Jowa	W9ARE	MIDWEST DIVISION Clyde C. Richelieu	Route 6, c/o U. S. Airway Commun. Sta.
Kansas Missouri Nebraska	W0UEG W9OUD W9FAM	Melvin D. Kirby Miss Letha Altendorf Samuel C. Wallace	Burlington Arlington Joplin Clarks
Connecticut Maine Eastern Massachusetts Western Massachusetts New Hampshire Rhode Island Vermont	W1CTI W1FBJ W1IWC W1JAH W1BFT W1HRC W1GNF	NEW ENGLAND DIVISION Frederick Ella, Jr. Winfield A. Ramsdell Sam Gross William J. Barrett Carl B. Evans Clayton C. Gordon Alvin H. Battison	19 Merrill Rd. 1188 Washington Ave. Pleasant St. 239 Columbia St. 80 No. State St. 192 Washington Ave. 1 Central St.
Alaska Idaho Montana Oregon* Washington	K7ENA W7EMT W7EFL W7KV W7FCG	NORTHWESTERN DIVISION Leo E. Osterman Carl Eichelberger C. Woodhouse Ralph J. Gibbons W. Beale	Customhouse Route 2 Hotter Dam c/o United Air Lines R. 4, School Ave.
Hawaii* Nevada Santa Clara Valley East Bay San Francisco Sacramento Valley Philippines San Joaquin Valley*	K60TH W6BIC W6FBW W6JTV W6SG W6GZY K6IGR W6NJQ	PACIFIC DIVISION Hugh Cecil Rea Edward W. Heim Elbert Amarantes Harold J. Burchfield Alan D. Whittaker, Jr. J. L. C. Buckenham George L. Rickard Clarence Ramer	1925 Keeaumoku St. 509 Claremont St. 454 Washington St. 2240 106th Ave. 79 Elinor Ave. 2729 22nd St. Box 849 941 Clinton Ave.
North Carolina South Carolina Virginia West Virginia	W4QG W4BOE W3UVA W8HD	ROANOKE DIVISION H. S. Carter Ted Ferguson Charles M. Waff, Jr. C. S. Hoffmann, Jr.	P. O. Box 111 1213 College St. 2607 Stuart Ave. 47 Lynwood Ave.
Colorado Utah-Wyoming	W9FA W7CLG	ROCKY MOUNTAIN DIVISION Glen Glasscock Ernest E. Parshall	2164 So. Corona St. Salt Creek Electric Plant
Alabama Eastern Florida Western Florida* Georgia West Indies (Cuba-Isle-of-Pines- Porto Rico-Virgin Islands)	W4DGS W4DVO W4AXP OM2OP	SOUTHEASTERN DIVISION James F. Thompson L. A. Connolly Oscar Cederstrom	1203 South Perry St. 719 So. Willow Ave. Second St. & Bruce Ave.
Los Angeles Arizona San Diego	W6MQM W6KFC W6JRM	SOUTHWESTERN DIVISION Mario de la Torre	Escobar 110 (Altos)
Northern Texas Oklahoma Southern Texas New Mexico	W5DXA W5CEZ W5BHO W5CGJ	WEST GULF DIVISION Lee Hughes Carter L. Simpson Dave H. Galk Joseph M. Eldodt	1038 Milwaukee Ave. 747 E. Polk St. R. 2, Box 636
Maritime	VE1DQ	MARITIME DIVISION A. M. Crowell	125 N. Main St. 2010 So. 4th St. 6726 Ave. Q
Ontario	VE3SG	ONTARIO DIVISION Fred H. B. Saxon	69 Dublin St.
Quebec	VE2EE	QUEBEC DIVISION Stan Comach	302 Lee Ave.
Alberta British Columbia	VE4GE VE5HP	VANALTA DIVISION C. S. Jamieson J. Hepburn, Jr.	780 Brault Ave.
Manitoba Saskatchewan	VE4BG VE4SV	PRAIRIE DIVISION A. J. R. Simpson Arthur Chesworth	581 W. Riverside Drive 335 Foul Bay Road

* Officials appointed to act until the membership of the Section choose permanent S.C.M.s by nomination and election.

News!

TO ALL OUR AMATEUR FRIENDS . . .

KENYON "T"-LINE TRANSFORMER

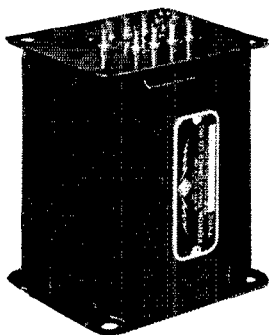

• FEATURES •

1. Completely dehydrated and specially vacuum-varnish treated units.
2. Hermetically sealed, fully poured in casings for protection against moisture and adverse atmospheric conditions.
3. All types in one attractive style casing for uniform, commercial-looking equipment.
4. Entirely shielded, core and all.
5. Universally mounted, upright or inverted.
6. Compact terminal board design permits convenient under chassis terminal connections in one-hole inverted mounting position.
7. Highest quality construction throughout for lasting satisfactory service.

IN order to serve the multitude of our amateur friends who experience any difficulty, delay or inconvenience in obtaining KENYON "T"-LINE transformers in their particular locality, arrangements have now been made for them to obtain them direct from the factory at regular retail prices. Therefore, if your local jobber-dealer cannot supply you KENYON "T"-LINE from stock, send us your order direct together with your remittance covering same, and the name of your local jobber-dealer. Your order will be promptly shipped prepaid anywhere in the U. S. A.

Your local KENYON distributor will receive full credit on your order which will also enable him to serve your future requirements. Regular amateur discount is 40% off list prices shown in your KENYON "T"-LINE catalog. If you don't have a complete "T"-LINE catalog, write for your copy NOW!

• • •

Don't be misled to accept substitutes for genuine KENYON "T"-LINE transformers. Look for the KENYON Diamond-K trade mark and "T" line type number. A complete line for every amateur transmitter application, including sound and television equipment.



KENYON TRANSFORMER COMPANY, INC.

840 BARRY STREET

NEW YORK, N. Y.

Export Department 25 Warren St., New York, N. Y.

ADVERTISEMENT

Say You Saw It in QST — It Identifies You and Helps QST

The American Radio Relay League



DIRECTORS

President
EUGENE C. WOODRUFF.....W8CMP
234 W. Fairmount Ave., State College, Pa.

Vice-President
GEORGE W. BAILEY.....W1KH
74 Webster Road, Weston, Mass.

Canadian General Manager
ALEX REID.....VE2BE
169 Logan Ave., St. Lambert, P. Q.

Atlantic Division
WALTER BRADLEY MARTIN.....W3QV
Box 612, Roslyn, Pa.

Central Division
R. H. G. MATHEWS.....W9ZN
100 East Ohio St., Chicago

Dakota Division
FRED W. YOUNG.....W9MZN
Apartment 16, 300 Harvard St., Minneapolis, Minn.

Delta Division
E. RAY ARLEDGE.....W5SI
P.O. Box 286, Pine Bluff, Ark.

Hudson Division
KENNETH T. HILL.....W2AHC
115 Willow St., Douglaston, L. I., N. Y.

Midwest Division
FLOYD E. NORWINE, JR.....W9EFC
120 South Fourth St., St. Louis, Mo.

New England Division
PERCY C. NOBLE.....W1BVR
37 Broad St., Westfield, Mass.

Northwestern Division
RALPH J. GIBBONS.....W7KV
c/o United Air Lines, Portland, Ore.

Pacific Division
J. L. MCCARGAR.....W6EY
66 Hamilton Pl., Oakland, Calif.

Roanoke Division
H. L. CAVENESS.....W4DW
State College Station, Raleigh, N. C.

Rocky Mountain Division
EDWARD C. STOCKMAN.....W9ESA
618 So. Williams St., Denver

Southeastern Division
BENNETT R. ADAMS, JR.....W4APU
1512 Grove Place, Homewood, Ala.

Southwestern Division
CHARLES E. BLALACK.....W6GG
443 Main St., El Centro, Calif.

West Gulf Division
WAYLAND M. GROVES.....W5NW
c/o Humble Pipe Line, Mt. Pleasant, Texas

THE AMERICAN RADIO RELAY LEAGUE, INC., is a non-commercial association of radio amateurs, bonded for the promotion of interest in amateur radio communication and experimentation, for the relaying of messages by radio, for the advancement of the radio art and of the public welfare, for the representation of the radio amateur in legislative matters, and for the maintenance of fraternalism and a high standard of conduct.

It is an incorporated association without capital stock, chartered under the laws of Connecticut. Its affairs are governed by a Board of Directors, elected every two years by the general membership. The officers are elected or appointed by the Directors. The League is non-commercial and no one commercially engaged in the manufacture, sale or rental of radio apparatus is eligible to membership on its board.

"Of, by and for the amateur," it numbers within its ranks practically every worth-while amateur in the nation and has a history of glorious achievement as the standard-bearer in amateur affairs.

Inquiries regarding membership are solicited. A bona fide interest in amateur radio is the only essential qualification; ownership of a transmitting station and knowledge of the code are not prerequisite. Correspondence should be addressed to the Secretary.

HIRAM PERCY MAXIM, FIRST PRESIDENT

OFFICERS

President.....EUGENE C. WOODRUFF, W8CMP
State College, Pa.

Vice-President.....GEORGE W. BAILEY, W1KH
Weston, Mass.

Secretary.....KENNETH B. WARNER, W1EH
West Hartford, Connecticut

Treasurer.....ARTHUR A. HEBERT, W1ES
West Hartford, Connecticut

Communications Mgr....F. EDWARD HANDY, W1BDI
West Hartford, Connecticut

General Counsel.....PAUL M. SEGAL
1026 Woodward Building, Washington, D. C.

Address all general correspondence to the administrative headquarters at West Hartford, Connecticut



"It Seems to Us — —"

WE learned an interesting thing in a rag-chew with some Federal Communications Commission people recently. It seems that their off-frequency citations by the monitoring stations show an unbelievable number of amateur "repeaters" who apparently keep on using the same crystal after it has been shown to be outside a ham band and who get caught again and again for the same out-of-band operating. We have talked this over with several amateurs and haven't found one yet who could believe that there were amateurs that dumb but we have satisfied ourselves that the account is correct and we want to pass it on to you.

We suppose a few of these cases represent amateurs who think they are smart and who knowingly work slightly outside a band in the hope that they can get away with it. Amateur radio is so vast a body that there are almost bound to be a few such fellows in it. But most of these repeats certainly seem to indicate a species of dumbness that reflects no credit upon us. Consider, for example, the order of intelligence displayed by the ham operator who is cited for being out of the band, say on 14,404, when his arithmetic led him to believe that he was on 14,396, but who keeps on using the same hunk of rock. A short while later he gets simultaneous citations from two more monitoring stations reporting the same bad news of 14,404. Wouldn't you think he would know by then that his wasn't a crystal that would yield him 14,396? Yet the F.C.C. say they have scores of cases where fellows "don't see how it could have happened," keep on using the same slab, and incur increasing penalties and the cascading inconveniences for successive violations of the same reg. They even get cited for being out of other bands and a little examination of the harmonic relationships shows that the same faulty crystal was still in use.

If there is any reasonable explanation for this course of conduct beyond the take-a-chance business, it must be that there are amateurs who regard the monitoring stations' measurements as less accurate than the alleged frequency rating of their pieces of quartz. Truth is, of course, that the monitors have apparatus of very high precision and are frequently able to measure a ham frequency to ten cycles; and when two or more of

them intercept and measure the same amateur transmission, it is remarkable in what close agreement they are.

The mere employment of a piece of quartz bearing a magic figure a few kilocycles inside a band certainly does not assure trouble-free operation. The sooner we realize that the happier we shall be. That is one reason why the F.C.C. is now requiring all amateurs to possess themselves of means for separately measuring output frequency with at least sufficient accuracy to be sure of being within a band. The best of crystals have some drift, particularly in the conditions under which many of us use them. Obviously no crystal's frequency can be relied upon except in the holder in which it was calibrated. And even then it wouldn't begin to be reliable except under the same circuit conditions and temperature as had obtained when it was measured. Moreover, there are all kinds of quartz plates, some most indifferently cut and ground, many capable of wild drifting and hopping to frequencies many kilocycles removed from what the owner fondly believes. And didn't we ourselves join the Hq. Pink-Ticket Club a few months back from having pushed the edge of the band a little too hard with a rubber xtal in quest of an elusive FI! Two mornings later we received greetings from Mr. Grand Island—socko! Much ill-concealed glee around the Hq. Gang and no sympathy whatever for us while we sweated around cooking up the usual line to the F.C.C. on howcum it happened and how it wouldn't happen again.

Bright guys, aren't we?—ourselves included. Let's wake up. These monitoring stations are accurate. Crystal control doesn't assure freedom from trouble; we have to *know* where we're operating. And when citations show us stuck with a bad rock, let's not continue being saps and using the same treacherous stones. Experience shows it doesn't pay.

THE recent invasion of New Jersey by the rocket-ships from Mars brought forth a comment from Chairman McNinch of the F.C.C. Said he, "Public reaction again demonstrates the force of radio and points out again the serious public responsibility of those who are licensed to operate stations." He wasn't talking about

amateurs, of course, but there's a moral in it for our 'phone men nonetheless. Apparently only about one BCL in a thousand knows that there is any amateur radio beyond the 'phone operation he hears on his all-waver. 'Phone stations therefore are our flag-bearers before the general public. The things that are said by voice aren't always a credit to us—which is probably understatement. We'd like to appeal to 'phone men to remember that theirs is the only operation that the BCL can understand; that they therefore have in their keeping the good name of all of amateur radio; and, to quote Mr. McNinch, we ask that they keep in mind "the serious public responsibility of those who are licensed to operate stations."

IN two other places in this issue we discuss our new regulations, which ought to be enough; but we feel that we are entitled to crow just a bit about our new emergency-communication regs. You have all seen the letter in last *QST* wherein the Red Cross says that amateur performance has definitely shown them that it is an essential part of disaster relief work and that their future planning will be more and more based upon cooperation with amateurs. At last we have some

government rules with teeth in them that insure our ability to deliver a better job. The adoption of these rules by the administration is a real recognition of the public value of our services in time of stress. The proposals of the A.R.R.L. Board of Directors, originated by our Communications Department, were enacted by the F.C.C. without substantial change. From now on there is a new deal during emergencies; the regs mean something. Amateurs who participate in relief work will have protection from needless interference. Emergency stations in isolated communities will have potent assistance. Operators not intending to assist in the work must pipe down on the 1715-2000 and 3500-4000 bands whenever and wherever the Commission proclaims an emergency to exist. Increased opportunity, increased responsibility. On both counts, every amateur owes it to himself to become thoroughly familiar with the privileges and limitations set forth in the new emergency rules, and we recommend their careful study. We think you'll agree with us that the increased public trust they put upon amateur radio is highly complimentary. To work, then, and let's justify that confidence!

K. B. W.

Circulation Statement

PUBLISHER'S STATEMENT OF CIRCULATION AS GIVEN TO STANDARD RATE AND DATA SERVICE

This is to certify that the average circulation per issue of *QST* for the six months' period January 1st to and including June 30, 1938, was as follows:

Copies sold	42,651
Copies distributed free	408
Total	43,059

K. B. Warner, Business Manager

D. H. Houghton, Circulation Manager

Subscribed to and sworn before me on this 12th day of September, 1938

Alice V. Scanlan, Notary Public

Our Cover

IT'S old stuff to see curling irons and flat irons that looked positively white-hot in photographs. These shots were of the heat or infra-red rays, which are invisible to the eye but will record on special film. It occurred to us that our transmitters should be sources of interesting shots. The amateur photographers of the office were consulted and an interesting evening with the invisible rays resulted. Considerable experiment was necessary to arrive at the proper exposure, but the final result leaves little doubt that there was plenty of output and a bit of heat in the coil.

Now for the real low-down see page 42.

Strays

Add this to the cases of ham 'phone stations picked up by motion-picture theaters, broadcast stations, and telephones:

W9YJS was recently picked up by the electric organ amplifier during a church service in Kansas City, Mo. No modern miracles?!!

— — — —

General Electric Bulletins GES-1996 and GES-1999 are azimuthal world projection maps centered on Schenectady, New York, and Oakland, California, respectively. These bulletins, printed on letter-size paper, should be convenient for use on the operating tables of DX men.

Silent Keys

IT IS with deep regret that we record the passing of these amateurs:

Fred S. Ambrose, W8QZF, Altoona, Pa.
Maurice N. Boutilier, W1LDH, Houlton, Maine

John Robert Dienes, W9QLP, Fort Meade, S. D.

Harold D. Edenfield, W9SJV, Edgerton, Kansas

George J. Quick, Jr., W3AZF, Philadelphia, Pa.

John J. Varihy, W9DSZ, Terre Haute, Indiana

We Have New Regulations

New F.C.C. Rules Effective Dec. 1st; Many Important Changes in Apparatus Requirements, Operating Practices and Licensing Procedure

By Kenneth B. Warner,* W1EH

JUST too late for us to publish the complete text last month, the Federal Communications Commission on October 4th adopted complete new amateur regulations which replace our existing rules on December 1st. This is big news. Every amateur now needs to know just what changes he must make in apparatus and procedure in order to comply.

On page 27 of last month's issue we highlighted the important changes in the regulations. For a birds'-eye view of the more significant amendments we refer you to that article. This month we propose to go serially right through the new text, pointing out the changes and endeavoring to explain their significance and the reasons behind them. We shall treat only the *changes*. And at the end of this article we print the complete new text of the regulations, which should be carefully consulted to get the exact wording on matters in which the reader is interested.

Known as "Rules Governing Amateur Radio Stations and Amateur Radio Operators," our new regs constitute Chapter XII of the complete rewriting job in which F.C.C. is giving all its regulations. Ours are divided into three parts, with a decimal numbering system. All of our definitions are segregated into what is known as Part 150, while Part 151 deals with operators and Part 152 with stations. Let us now apply the microscope and examine our new rules seriatim.

PART 150—DEFINITIONS

Here we have no changes except in arrangement. Most of the text is exactly the same. Some of it has long applied to all the radio services and is here brought into the amateur regulations simply to make our set of rules complete.

PART 151—AMATEUR OPERATORS

The rules for licensing operators have been entirely rewritten, greatly clarified and arranged in logical sequence. There are only a few changes to point out, the numbers we use being the numbers of the rules themselves as found at the end of this article.

151.01. To be eligible for Class A, an appli-

* Managing Secretary, A.R.R.L.

cant must have had at least one year's experience as a licensed c.w. amateur. Note that this experience is now required to be within five years of applying for Class A.

151.06. When proving activity for renewing an operator license, the three stations communicated with must be amateur stations licensed by F.C.C. The Commission no longer accepts foreign DX for these QSO's, because it has no way of verifying claims of DX contacts.

151.07. While it has long been provided that a person not duly licensed may speak over the microphone of an amateur 'phone station only if a duly licensed operator is in control, it is now specified that only this licensed operator

may turn the carrier on and off when required and sign off the station at the end of the transmission. Don't let your non-ham wife or unlicensed guests sign off for you and throw switches; and if you are working in the Class A 'phone bands, don't even let a Class B licensed operator do it, for he is not "duly licensed" for the Class A bands.

151.18. One relaxation for Class C applicants: If the code examiner is not a Class A or B amateur, he may be a person who anytime within five years has held a professional radiotelegraph operator's license or has been a government radiotelegraph operator; he does not necessarily have to be so licensed or employed at the time. One tightening up: The examiner for the written test, if not the same individual, must be a person of legal age; no more having your written examination monitored by your four-year-old son—hi!

151.19. Here is a real one. Whenever a Class C ham moves to a point where he would not have been eligible to apply for Class C in the first place, or whenever a new examining point is established so that its 125-mile circle includes him, he must take and pass the Class B examination within four months. This is a logical rule, as the Class C arrangement is intended exclusively for those who live beyond reasonable traveling distance. There are many Class C amateurs in large cities, holding licenses that they got when they lived at remote points. Let them now take note

IMPORTANT
to every radio amateur are these changes in our regulations, becoming effective December 1st. Every amateur ought to read this article with scrupulous care and prepare to modify his practices in accordance therewith. The monitoring stations commence enforcement of the new rules at 3 A.M., E.S.T., December 1st.

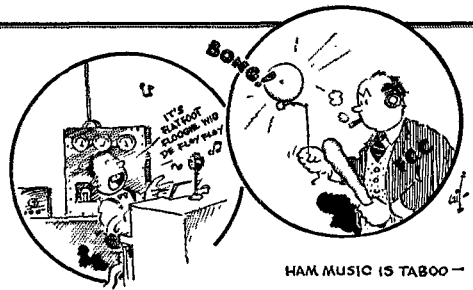

that they must qualify under Class B before April 1st. A 125-mile circle is just being drawn around San Juan, P. R., and all K4 holders of Class C except in the Virgin Islands must qualify before April 1st.

151.20. The possession of a Class A license within five years preceding examination now eliminates the need for taking the theory part of any of the amateur examinations; only code and knowledge of regulations are tested. However, because it is now over five years since there were any amateur extra-first-grade licenses or any endorsement on normal amateur licenses for "unlimited privileges," the recognition of these old types to escape part of the examination is dropped.

151.21. The special arrangements for physically disabled applicants, long in practice, are now incorporated in our regs. One interesting provision is that if an applicant is physically unable to draw the required diagrams, he may instead make a detailed verbal description essentially equivalent.

151.23. It used to be that if an applicant failed an examination, he had to wait three months before trying again. This is now reduced to two months.

All amateurs are familiar with the fact that when a station license is modified, as in the case of change of address, the license is rewritten for a new term of three years. Not all amateurs have been aware that in the past this practice has not applied to modification of operator license, as for a change in class of privileges; and some confusion has resulted. To overcome this, the Commission will now start a new three-year term whenever *either* license is modified or reissued, when they have been issued jointly as they are in most amateur cases.

PART 152—STATIONS

Here again there is considerable rewriting and a logical rearranging.

An old restriction disappears: Rule 366a, requiring a person who applies for only an operator license to wait at least three months before applying for a station license, is repealed.

152.01. The old regs required an applicant to make a satisfactory showing of control or

ownership of apparatus. Control is the important thing, and that is the only factor mentioned in the new text. It adds, however, a requirement for showing control of premises. And Section 152.03 requires that not only the station but the control point thereof, if remote control is authorized, must be located on premises controlled by a citizen.

152.02. Retaining the old provision that, except in the case of *bona fide* clubs, only individuals may hold station licenses, the language now becomes more specific and excludes schools by direct reference; moreover it says that such a license will not be issued to a school nor for its use. This is a desirable tightening up, because school stations masquerading as amateurs, and sometimes holding their licenses through dummy clubs, have long impressed us as improper occupants of amateur bands.

152.05 is a valuable restatement of the principle that one station license authorizes the operation of all transmitting apparatus used by one licensee at one location and in addition authorizes portable and portable-mobile operation.

152.06. Heretofore, replacement of an expiring station license has been denied for three months if proof of use could not be shown. The suspense period is now reduced to two months. Where proof of use is shown, the three contacts must be with American Amateur Stations; foreign DX is no longer accepted.

152.08. Maintaining the general principle that special requests for calls will not be honored except that one may be reassigned to the latest holder, F.C.C. now goes a little further and says that if the call has not been under license during the preceding five years, it may be reassigned to any previous holder. An amateur organization may also receive the call of a deceased member to be employed in memoriam to him.

152.10. Old regulations required the transmission of the station call at the end of each transmission and at least every fifteen minutes during transmissions of more than that length. This figure is now reduced to ten minutes; the station must sign oftener, to facilitate its identification. On the other hand, we now have a clarification of the practice to be observed in break-in operation: Amateurs have long wondered whether the requirement to sign "at the end of each transmission" meant each time they had simply said

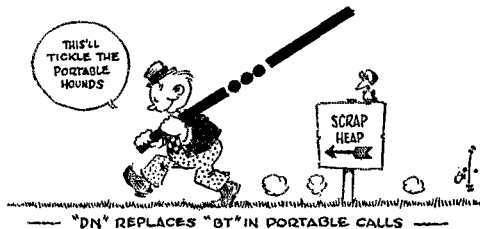

“yes” or “OK” in break-in operation. It is now provided that stations employing break-in do not need to identify transmissions of less than a minute's duration except by signing their call every ten minutes of operation and at the termination of the correspondence. If any transmission lasts over a minute, however, it must be signed — which everyone will admit is not unreasonable. Finally, in this section, we get a real break: the designator for portable operation is changed from the much-hated double break BT to the much more logical fraction-bar character DN. The use of the double break has been extremely confusing and we finally sold the Commission on making the change to the diagonal mark. It simplifies logging and writing the calls also, thus, W1EH/1.

152.12. Concerning the notice to inspectors of intended portable operation, the old regulations required simply a statement of the approximate locations of operation but the new text requires the naming of the locations as specifically as possible. An addition to this section is the statement that portable operation will not be permitted for more than four consecutive periods of one month at the same location.

Sec. 152.13 contains the long-expected clarification of portable regulations, and is important. With two exceptions, the provisions for portable operation may not be applied to any non-portable station. We are thus forbidden to sign our own call at any other amateur's “fixed” station by going through the mental gymnastics of considering it our portable location. The portable provision is not thus to be abused; it is to be confined to *bona fide* portable stations with two exceptions that the F.C.C. wisely recognizes as being in our mutual convenience: (a) when an amateur moves and applies for modification, he may operate his regular station at the new address in portable status while awaiting the new license but for not over 60 days; (b) when an amateur is temporarily residing at a location other than his permanent one for not over four months, intending thereafter to return to his permanent address, he may operate his own fixed station in portable status. This provision (b) is to avoid the necessity of modifying licenses to change the address twice a year in the case of summer vacationers, students home from college for the summer, etc. However, in both of these cases the rules governing portable operation must be carefully followed.

152.14. Discussing the communication in which we may engage, an important concession has been gained from the Commission in the last sentence of this section which, under proper restrictions, authorizes one-way transmission to points equipped only with receiving apparatus—as the only exceptions to the general rule that amateur stations engage only in two-way amateur communication. (Our O.B.S. system is specially provided for.) The authorized one-way

transmission is confined to emissions for the purposes of measurement, observation of transmission phenomena, radio control of remote objects, and similar purely experimental purposes. The Commission absolutely declines to authorize amateurs to engage in one-way 'phone monologues. It is unfortunate that provision could not be made for the more-nearly legitimate case of amateurs desiring to talk to their own relatives equipped only with receiving apparatus, but it was felt that if the bars were let down on this,

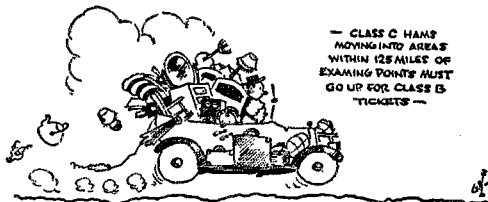

there would be inevitable great abuse and the air would be filled with one-way transmissions that have no relation to amateur work. Thus only the exceptions enumerated are to be permitted, and one-way transmission of any other nature will result in citation. Note, however, that we now have authorization for the radio control of model aircraft, for making field-strength measurements, and other purely experimental work.

As every amateur knows, the right to transmit music for *bona fide* audio-frequency tests has always been abused, its most common form being 'phone stations playing phonograph records at each other or aspiring to be miniature local broadcasters for selected BCL friends. The new Sec. 152.17 now forbids the transmission of music. For amateurs genuinely interested in 'phone experimental work, where audio qualities should be tested and measured under actual space-transmission conditions, single audio-frequency tones, selected at will, may be transmitted for test purposes of short duration. Which, of course, is the scientific way of doing it anyway.

We come now to an important group of rules dealing with the allocation of our frequencies and their subdivision for different types of emission. Sec. 152.25 assigns to us not only our familiar frequency bands but also two new u.h.f. bands, 112–118 Mc. and 224–230 Mc. These new bands were set aside for amateurs in the Commission's extensive allocation studies for the ultra-highs but the general order allocating those frequencies to services does not take effect until next April. However, at the special request of the A.R.R.L., which pointed out that there were no conflicts concerning our u.h.f. bands to warrant delays, the F.C.C. is giving us our new bands on December 1st. Because the general u.h.f. allocation is not yet in effect, the F.C.C. is protecting itself meanwhile with a footnote reference opposite

these two bands stating that they reserve the right to change or cancel them without advance notice or hearing. It will be noted that this footnote appears opposite every reference to these two new u.h.f. bands. We regard this as purely a legal technicality; it will be dropped after next April. In the same fashion, another footnote reference appears opposite every reference to our 1715-2000 band stating that it is subject to change to 1750-2050 kc. in accordance with the Habana agreement; it is expected that this change will take place about the first of the year.



For the past several years, while u.h.f. allocation was under study, amateurs and all other experimental services have had a temporary joint right to operate on all u.h. frequencies above 110 Mc. Everyone has recognized that this was but temporary, pending definite allocation. In fact, in order to be able to find each other, we amateurs have confined ourselves to emissions commencing at 112 and 224 Mc. Now that we have the two new bands definitely allocated for our exclusive use, the temporary right above 110 Mc. is changed to a new figure, the new limit beyond which allocations are not being made. Sec. 152.26 gives amateurs the right to operate, with any type of emission, on any frequency above 300 Mc. without additional license.

The two new u.h.f. bands are opened to radiotelephony by all classes of amateurs (152.27), to A-2 emission (152.32), to facsimile transmission, which includes "picture transmission" (152.30), and to television and radiotelephone frequency-modulation transmission (152.29). This last provision is a new one and provides opportunity for amateurs to experiment with phase-modulation methods such as Armstrong frequency-modulation. However, these types of emissions that occupy immense band width, including television, are now confined in Sec. 152.29 to the ultra-highs, and the right to make television transmissions in the 1715-2000 and 56-60 bands has been cancelled because the general use of these bands is now so great that television use could not be tolerated. This modification was requested by the A.R.R.L. Board.

A very important change occurs in the Class A 'phone allocations. The frequency bands remain the same but there is now the stipulation that these bands may be used for 'phone only in the

case of a station licensed to a person who holds a Class A operator license. As we all know, the old regulations contained a loophole which permitted a Class B amateur to bring into his station a Class A operator and have the latter operate the station in these special bands. This was in violation of the spirit of the regulation, which was intended to confine the use of these additional bands to those who demonstrated special aptitude by passing the Class A exam. Note that from now on the licensee himself must hold Class A privileges.

There is an addition to Sec. 152.31 (which gives amateurs the right to work anywhere in a band) now stipulating that side-band frequencies resulting from keying or modulating must be confined within the frequency band used. This is not a new requirement but it appears in our own regs now for the first time.

Under the heading of equipment and operation, several new requirements appear. One of these, in Sec. 152.40, requires that transmitters using over 900 watts input shall be provided with means for accurately measuring the plate power to the final stage. F.C.C. says there are too many cases of amateurs using "about" a kilowatt and not actually knowing, and they feel that a fellow who can afford a kilowatt rig can afford the necessary voltmeter and milliammeter to make sure that the input does not exceed the very generous legal limit. We ourselves feel that it is desirable for every amateur station to have measuring equipment, particularly since it is required to log the input power, but the legal requirement to own such equipment is confined to those who approach the kilowatt mark.

152.41 and 152.42. No more modulated oscillators and raw a.c. in the 5-meter band. The requirement to use adequately-filtered d.c. supply, have stable signals and to avoid over-modulation and frequency modulation is now extended to 60 Mc. The same rules now apply to this band that have previously applied below 30 Mc. *QST* recently took a poll of membership sentiment on this question and found about 87 per cent of the replies in favor of the change, so we are sure it will be generally acceptable. Simple transceivers and self-excited oscillators and other experimental apparatus of lower performance may still be used above 112 Mc.

We quote 152.43 in full: "Except for brief tests or adjustments, an amateur radiotelephone station shall not emit a carrier wave unless modulated for the purpose of communication." No more of this abuse of turning on the carrier while eating dinner in order to blast a channel through the spectrum; no more alleged "duplex" by leaving the carrier on while receiving. These are selfish practices, causing twice as much interference as necessary. Their prohibition now is intended to give "the other fellow" a break.

We come now to a discussion of what is prob-

ably the most important change in the regulations, 152.44. This requires each amateur station both to provide for the measurement of the transmitter frequency and to establish a procedure for checking it regularly. It is required that the frequency measurement shall be by means independent of the frequency control of the transmitter, and of sufficient accuracy to insure operation within the band chosen. There is still a great deal too much out-of-band operation. The new requirements will not be found arduous except for the chaps who wish to shave the edge of a band. Considering how important it has become in these congested days not to transgress upon the frequencies of another service, it is probably not unreasonable to require our edge-clippers to possess precision measuring equipment. We suggest that amateurs who work in the central portion of a band are already prepared to comply with this section simply by listening to their signal on their receiver, disconnecting the antenna if necessary—which simple procedure constitutes an independent means of assuring that the signal is within the band. For frequencies that begin to approach the band limits, stable calibrated receivers or monitors should do. To work close to the edges, frequency meters probably will be necessary, and it is obvious that this will have to be precision equipment in the case of kilocycle-splitters. The rule applies also to 'phone stations confined to a portion of a band; it is as important for a 14-Mc. 'phone to be inside 14,250 kc. as it is for a c.w. station to stay under 14,400. See our next issue for more specific technical assistance on this subject. Note that ownership of measuring equipment is not actually specified; it may be borrowed or arrangements may be made with a cross-town amateur possessing precision equipment to make the necessary measurements, or a commercial laboratory might be engaged to do the job. It is necessary, however, to "establish procedure for checking the frequency regularly."

Sec. 152.45 introduces two new items concerning logs. Heretofore it has been necessary simply to log the name of the person operating the transmitter and the name of any other person who transmits by voice. Signatures are now required, including all persons who speak over the mike. You should have them actually sign the log. The other requirement is that the log shall be preserved for a period of at least a year following the last entry. Log-keeping is of increasing impor-

tance. Always valuable to the amateur himself as a source of data, it is now regularly called for by the F.C.C. when an amateur is in difficulty for any



reason, and we have seen many a fellow in hot water recently because his log did not comply with the prescriptions. We recommend a full study of this section.

The last group of regulations is prefaced by an introductory statement (152.50) that amateur station licenses are granted subject to certain conditions and that licensees receiving notice to observe such conditions must immediately conform. Amongst these conditions is our old specification of quiet hours (152.51) in case of general BCL interference, the same figure for the quiet hours having been retained after quite a tussle. There is then incorporated in our regulations a detailed statement of the procedure to be followed by an amateur cited for successive violations of the same section. While this procedure has been standard F.C.C. practice for some years, it has not previously been recited in our regs. Sec. 152.52 deals with second violations in a year of the regulations prescribing amateur frequencies and the quality of signals and it puts the station off the air during the desirable hours from 6 p.m. to 10:30 p.m. until tests have been made with other amateurs, a report made to the Commission and the Commission's authority received to resume fulltime operation. In similar fashion, Sec. 152.53 deals with a third violation and denies the station the right to operate between 8 a.m. and midnight until a prearranged test can be made with an F.C.C. monitoring station and the Commission's permission received to resume operation.

There then follows, in Sec. 152.54, what is probably the most valuable addition to the regulations, the arrangements set up to govern amateur communication in emergencies. These provisions have been actively sought by the A.R.R.L. for nearly two years back and we are pleased to report that they now have the effect of law and that they greatly increase the power of amateur radio to contribute to the public welfare in time of



— ESTABLISH PROCEDURE FOR CHECKING THE FREQUENCY REGULARLY

need. It is now provided that, whenever the F.C.C. declare a state of general communications emergency within a certain range the 1715-2000 and 3500-4000 bands may be used *only* for amateur emergency service in that region (although the other amateur bands are not affected). The portions 1975-2000, 3500-3525 and 3975-4000 kc. are designated as emergency calling channels. Amateurs in isolated communities should use these frequencies for first contacts to get assistance. All other amateurs operating in these two bands during emergencies are obliged to observe a listening period during the first five minutes of each hour. Provisions are made for the appointment of amateur monitoring stations to spread the word of the existence of the emergency, to pipe down non-participating stations and to report non-complying stations to the F.C.C. A more detailed explanation of the methods to be followed under this section will be presented by our Communications Department.

While this completes the examination of the specific amateur rules in Chapter XII, there are other F.C.C. rules that concern the amateur, appearing in chapters that apply to all services. For example, there is the list of examination points, the specification of the procedure for filing applications and appeals and arranging for hearings, the rules governing the use of remote control, etc. The F.C.C. intends within a few weeks to make available a printing of the extracts of regulations applicable to amateurs, including not only our own rules but those others that are binding upon all licensees. We present now the new text of Chapter XII:

RULES GOVERNING AMATEUR RADIO STATIONS AND AMATEUR RADIO OPERATORS

Sec. 150.01. *Amateur service.* The term "amateur service" means a radio service carried on by amateur stations.

Sec. 150.02. *Amateur station.* The term "amateur station" means a station used by an "amateur," that is, a duly authorized person interested in radio technique solely with a personal aim and without pecuniary interest. It embraces all radio transmitting apparatus at a particular location used for amateur service and operated under a single instrument of authorization.

Sec. 150.03. *Amateur portable station.* The term "amateur portable station" means an amateur station that is portable in fact, that is so constructed that it may conveniently be moved about from place to place for communication, and that is in fact so moved from time to time, but which is not operated while in motion.

Sec. 150.04. *Amateur portable-mobile station.* The term "amateur portable-mobile station" means an amateur station that is portable in fact, that is so constructed that it may conveniently be transferred to or from a mobile unit or from one such unit to another, and that is in fact so transferred from time to time and is ordinarily used while such mobile unit is in motion.

Sec. 150.05. *Amateur radio communication.* The term "amateur radio communication" means radio communication between amateur stations solely with a personal aim and without pecuniary interest.

Sec. 150.06. *Amateur operator.* The term "amateur operator" means a person holding a valid license issued by the Federal Communications Commission authorizing him to operate licensed amateur stations.

LICENSES; PRIVILEGES

Sec. 151.01. *Eligibility for license.* The following are eligible to apply for amateur operator license and privileges:

Class A—A United States citizen who has within five years of receipt of application held license as an amateur operator

for a year or who in lieu thereof qualified under Section 151.20.

Class B—Any United States citizen.

Class C—A United States citizen whose actual residence, address, and station, are more than 125 miles airline from the nearest point where examination is given at least quarterly for Class B; or is shown by physician's certificate to be unable to appear for examination due to protracted disability; or is shown by certificate of the commanding officer to be in a camp of the Civilian Conservation Corps or in the regular military or naval service of the United States at a military post or naval station and unable to appear for Class B examination.

Sec. 151.02. *Classification of operating privileges.* Amateur operating privileges are as follows:

Class A—All amateur privileges.

Class B—Same as Class A except specially limited as in Section 152.28.

Class C—Same as Class B.

Sec. 151.03. *Scope of operator authority.* Amateur operators' licenses are valid only for the operation of licensed amateur stations; provided, however, any person holding a valid radio operator's license of any class may operate stations in the experimental service licensed for, and operating on, frequencies above 300,000 kilocycles.

Sec. 151.04. *Posting of license.* The original operator's license shall be posted in a conspicuous place in the room occupied by such operator while on duty or kept in his personal possession and available for inspection at all times while the operator is on duty, except when such license has been filed with application for modification or renewal, or has been mutilated, lost, or destroyed, and application has been made for a duplicate.

Sec. 151.05. *Duplicate license.* Any licensee applying for a duplicate license to replace an original which has been lost, mutilated, or destroyed, shall submit to the Commission such mutilated license or affidavit attesting to the facts regarding the manner in which the original was lost or destroyed. If the original is later found, it or the duplicate shall be returned to the Commission.

Sec. 151.06. *Renewal of amateur operator license.* An amateur operator license may be renewed upon proper application and a showing that within three months of receipt of the application by the Commission the licensee has lawfully operated an amateur station licensed by the Commission, and that he has communicated by radio with at least three other such amateur stations. Failure to meet the requirements of this section will make it necessary for the applicant to again qualify by examination.

Sec. 151.07. *Who may operate an amateur station.* An amateur station may be operated only by a person holding a valid amateur operator's license, and then only to the extent provided for by the class of privileges for which the operator's license is endorsed. When an amateur station uses radiotelephony (type A-3 emission) the licensee may permit any person to transmit by voice, provided a duly licensed amateur operator maintains control over the emissions by turning the carrier on and off when required and signs the station off after the transmission has been completed.

EXAMINATIONS

Sec. 151.15. *When required.* Examination is required for a new license as an amateur operator or for change of class of privileges.

Sec. 151.16. *Elements of examination.* The examination for amateur operator privileges will comprise the following elements:

1. Code test—ability to send and receive, in plain language, messages in the International Morse Code at a speed of not less than thirteen words per minute, counting five characters to the word, each numeral or punctuation mark counting as two characters.
2. Amateur radio operation and apparatus, both telephone and telegraph.
3. Provisions of treaty, statute and regulations affecting amateurs.
4. Advanced amateur radiotelephony.

Sec. 151.17. *Elements required for various privileges.* Examinations for Class A privileges will include all four examination elements as specified in Section 151.16.

Examinations for Classes B and C privileges will include elements 1, 2, and 3 as set forth in Section 151.16.

Sec. 151.18. *Manner of conducting examination.* Examinations for Class A and Class B privileges will be conducted by an authorized Commission employee or representative at points specified by the Commission.

Examinations for Class C privileges will be given by volunteer examiner(s), whom the Commission may designate or permit the applicant to select; in the latter event the examiner giving the code test shall be a holder of an amateur license with Class A or B privileges, or have held within five

(Continued on page 68)

H A M D O M



THE May issue of *QST* carried the following squib in the "How's DX?" section: "G6WY and others report that PJ3CO (14,300 kc., T7) in Curacao is ex-PA0XX. You might send your card care of the Netherlands QSL Bureau, but don't send it to Curacao. They don't like amateurs down there!"

Gentlemen, there's a story there. Here's the story, and I hope it's interesting enough to appear in your magazine.

The vacation I planned last January, a freighter trip to Haiti and Venezuela, included a three-day stopover at Curacao—an island which I had previously visited three times in the last five years. Before we ("we" including this SWL's

round-table that would put the best of rag chewers to shame. Here's how the story seems to go.

PJ3CO, who was born in Java, is a husky Dutch youth, a six-footer about twenty-eight years of age. His grandfather was a Scot who settled in Java and married a maid from Holland. I mention this because ex-PA0XX's full name is, believe it or not, Humphrey Arthur Crawford!

(Can you imagine a Hollander having this 100% British name?) His parents left the Dutch East Indies and moved to the Netherlands where he grew up and became interested in amateur radio. After putting his first rig on the air he picked his own call letters (PA0XX)

and went to work with a vengeance, specializing in DX.

Time marched on, and Humphrey could find no work outside of an occasional service job, replacing a tube or a new resistor in receiving sets of nearby friends. Conditions were far from good, so he enlisted in the Dutch army, chiefly because the government provides jobs to all those who leave Queen Wilhelmina's service with an honorable discharge.

Being born and raised in the tropics he volunteered to serve in Curacao. He was unaware that experimenting with amateur radio was forbidden on the island

until he arrived there last January. No one knew that in a wooden chest he carried a TNT rig, a home-made blooper, spare parts, antenna wire, a call book, log and QSL cards. For quite some time the radio gear remained intact under his cot in the fortress. However, the ham urge to pound a key finally got the better of him, and rigging up a "receiving" antenna he went to work with

(Continued on page 76)

This is not an orthodox Hamdom feature. Nevertheless, we feel that in both dramatic interest and possible humanitarian value it outranks most Hamdom stories. It is a contribution from Mr. William D. Watkins, of the Evening Record, Lansford, Pa.



Mrs. Watkins and PJ3CO—ex-PA0XX

Six days after leaving Brooklyn, we docked at Port-au-Prince, Haiti. Then came La Guaira and Porto Cabello, Venezuela, and finally Willemstad, the chief port of Curacao.

That evening as the XYL and I sipped rum punches on the broad, breezy veranda of the Hotel Americano, my friend hove into sight. After introductions, we settled down to enjoy the sea-breeze, refreshments and a QSO

A Simple Transmitter for Portable or Emergency Work

Crystal-Controlled Two-Tube Outfit with Single-Control Tuning

By Byron Goodman,* W1JPE

In designing this transmitter, a companion unit to the three-tube superhet described in August QST, full consideration has been given the same factors of low cost, light weight, compactness, low battery drain—and above all, simplicity of control and freedom from critical adjustments under the conditions usually existing during emergencies or in portable operation. The complete station assembly, with all necessary accessories, will be described in an early issue.

THE design of portable emergency transmitters depends almost entirely upon the available power supply. Many well-organized groups throughout the country have complete portable-emergency stations built around 300-watt or larger gasoline-driven generators. With so much power available, the design of transmitting equipment entails only good standard practice with rugged construction and an eye to complete reliability. However, the majority have to content themselves with low-powered gear that can be operated from batteries or a 300-volt

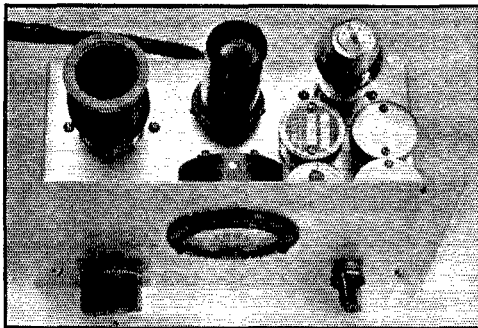

A SIMPLE PORTABLE-EMERGENCY TRANSMITTER

Using a 6C5-6L6 combination, this diminutive unit runs 20-35 watts input on 1.7, 3.5 and 7 Mc. Provision is made for switching crystals—one coil is changed when shifting bands.

Vibrapack or Genemotor source and a 6-volt storage battery. There seems to be little doubt but that the 6-volt storage battery is the logical primary source of power for low-powered portable-emergency work, except in cases where extreme light weight is a major consideration. With this in mind, a unit was designed as a companion-piece to the three-tube receiver described,¹ for 6-volt heater and 300-volt plate supply.

* Assistant Secretary, A.R.R.L.

¹ G. Grammer, "Three-Tube Super for Portable or Emergency Work," *QST*, August, 1938.

Except in rare instances, it seems desirable to use a two-stage transmitter rather than a single tube. The overall efficiency is about the same; it can be modulated more fully; and the plate meter can be used more easily for checking resonance and loading than in the case of a simple oscillator, where the minimum plate current is not always an indication of maximum output and best adjustment for keying. However, controls should be kept to a minimum, for ease in frequency-shifting and adjustment by unskilled operators. With these considerations, about the only line-up that will satisfy is the simple circuit used by W3EMM and his gang² in their portable stations. For simplicity, it was decided to modify it slightly by using smaller tubes and crystal switching. Since one of the bugaboos of portable

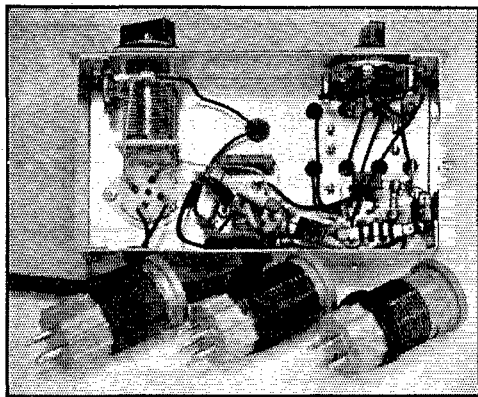

BENEATH THE CHASSIS OF THE PORTABLE

The tuning condenser is insulated from the panel by mounting through the front face of the condenser with small brass collars. The leads from the crystal sockets are brought through large holes or rubber grommets to the crystal switch. Coupling coils on the tank inductances are wound over the lower ends of the coils. Power and antenna leads are brought out the rear of the set through grommets.

² F. Priest and L. Turner, "Norfolk Amateurs Prepare for Emergencies," *QST*, September, 1938.

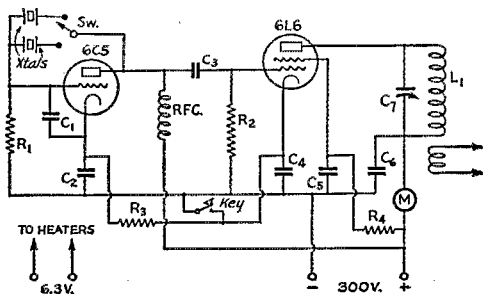

FIG. 1—WIRING DIAGRAM OF THE 6C5-6L6 PORTABLE-EMERGENCY TRANSMITTER

- C₁—50- μ fd. postage-stamp mica.
 C₂—0.002- μ fd. postage-stamp mica.
 C₃—250- μ fd. postage-stamp mica.
 C₄, C₅—0.005- μ fd. postage-stamp mica.
 C₆—0.01- μ fd., 600-volt paper.
 C₇—140- μ fd. midjet variable (Cardwell ZU-140-AS).
 R₁—25,000 ohms, $\frac{1}{2}$ -watt.
 R₂—100,000 ohms, 1-watt.
 R₃—1000 ohms, $\frac{1}{2}$ -watt.
 R₄—10,000 ohms, 2-watt.
 RFC—2.5-mh. r.f. choke.
 M—0-150-ma. milliammeter, 2-inch.
 Sw—4-position crystal switch (Yaxley 1316L).

L ₁ —	Band	Turns	Length	Coupling Coil Turns
	1.7 Mc.	46 No. 24 d.s.c.	close-wound	11
	3.5	25 No. 18 enam.	1 $\frac{1}{4}$ "	7
	7	13 No. 18 enam.	1 $\frac{3}{4}$ "	4

Coupling coil is close-wound with push-back wire over lower end of L₁.

operation is the antenna system, provision was made for incorporating simple half-wave doublets, fed by rubber-covered lamp cord, as part of the regular equipment. By using already-cut antennas and low-impedance lines, installing the antenna resolves itself into the simple process of finding suitable supports for the antenna and connecting the feed line. Any spare line can be coiled near the transmitter with no loss in efficiency. On the lower-frequency bands normally used during portable operation, the slight losses with good rubber-covered lamp cord (the 5-and-10 store variety is good enough) are not worth worrying about.

CIRCUIT

The circuit of the transmitter is quite straightforward. A 6C5G is used as the crystal oscillator, with the crystal connected between grid and plate. Using a 2.5-mh. r.f. choke in the plate circuit, this oscillator works nicely with 1.7-, 3.5- and 7-Mc. crystals and necessitates no tuning, a decided advantage during quick QSY. The oscillator is capacity-coupled to the 6L6 amplifier and the plate circuit of the 6L6 is tuned in the usual manner. A coupling coil wound around the bottom of the tank coil furnishes pick-up to the antenna feed-line. The set is keyed by opening both cathode circuits, giving clean and complete keying for break-in, plus maximum power economy. The 6L6 is quite stable in operation and

there is no need to neutralize it on any of the frequencies used. A 6L6G can be substituted but it takes up slightly more room and projects above the panel.

The transmitter is built on an aluminum chassis identical to that used for the receiver. It is folded from one piece of 1/16-inch thick aluminum and gives a chassis 4 $\frac{1}{2}$ x 8 x 2 inches deep. A pattern for folding can be found in the article on the receiver.¹ The panel is 8 $\frac{1}{2}$ x 6 $\frac{1}{2}$ inches. Sockets for the tubes and coil are mounted directly on the chassis; the sockets for the four crystals (these are the new Hammarlund SX-2 crystal sockets) are mounted above the chassis on the pillars supplied with them. The tuning condenser is mounted on the front panel but is insulated from the metal by mounting it with two small brass collars. The crystal switch is mounted directly on the chassis and panel and helps to hold them together.

The wiring is simple and straightforward, the only precaution being to see that every connection is thoroughly soldered (to avoid any later trouble) and that leads are well separated so that no short-circuits will appear at some inopportune time. The power-supply leads and a twisted pair for the antenna are brought out through rubber grommets at the rear of the set. Insulated tie-strips are used wherever necessary to add support to resistors, r.f. chokes and power-supply leads.

CHECKING PERFORMANCE

When the wiring has been completed and checked, the power supply leads can be connected to a 300- or 400-volt supply with 6.3 volts for the heaters. Remove the 6L6 and, with a crystal switched in, test the oscillator for keying by listening in a receiver or monitor. It should oscillate readily with a 1.7-, 3.5- or 7-Mc. crystal in the circuit, and the keying should be chirpless. Some experimentation with the value of C₁ may be necessary, although anything above about 30 μ fd. seems to be satisfactory. Without the condenser, there will be some difficulty in making all crystals oscillate and the output will be lowered, with poor keying. It is possible, by plugging-in the 6L6 and a tank coil, to make the oscillator work when it normally wouldn't by itself. However, this type of operation is not desirable, and the oscillator performance should be checked as described above.

The 6L6 and a proper tank coil can now be plugged in, and the amplifier performance checked. Open the lead between the grid leak (R₂) and ground, and insert a low-range milliammeter. With the key down and the final tuned to resonance, the grid current should be between 1.5 and 2 ma., with 300 volts on the plate of the oscillator. If the grid current is less than this, it indicates a poor crystal or insufficient capacity at C₁.

With the coil data given, the low-frequency

ends of the 1.7- and 3.5-Mc. bands should tune with the tank condenser C_7 practically all the way in. With less capacity, minimum plate current and maximum output will not occur at the same point and it will be difficult to tune by means of the plate meter, although the operation is otherwise unimpaired except that more turns

will be required for coupling to the antenna. The antenna coupling coil can be adjusted by putting on more turns than are necessary and removing them one by one until when, tuning through resonance with the tank loaded by the antenna, the plate current dips about 5 ma. With 330

(Continued on page 54)

A.R.R.L. Copying Bee—December 9th

TO COPY code accurately is the special mark of technique that distinguishes the real amateur. This is the annual opportunity to note our progress above the mere license requirement. The winner or as many as submit perfect copies will receive a striking bronze medal-
lion award from A.R.R.L.

As in the previous Bees, some unusual character and figure combinations and plain language groups will be sent in no particular sequence. The League will return all papers (except winners) with a copy of the transmitted texts to each participant with a confidential rating. Transmissions will all be 60 words in length. The sending will be by tape at about 25 words per minute. It will be a test to copy what you hear.

The following stations, all using "automatic" equipment, have been selected in the different time zones. Care will be taken to make all messages equally difficult by different words, word order, errors, etc. We urge everybody that knows the code at all to take part. Send in whatever you get, however little that may be. Check on your proficiency and have some good fun too.

All participants will be mentioned in QST. The schedule of transmissions for Friday night, December 9th is shown below:

The rules for taking part in the copying bee:

(1) Any amateur operator, not having access to the tape or transmission copies, and copying wholly by ear, is eligible.

(2) Mark one copy as your "best"; only this one copy shall count, but report all the above stations that you can hear to us. Keep copies other than your "best" to check yourself when we mail out the official texts to you.

(3) Print your name, call signal and address plainly on each entry.

(4) Send in original copies. Re-copying messages invariably introduces errors and detracts from credits.

(5) Copies must be mailed bearing a postmark in the year 1938 to be counted. Mail at once or within five days to make sure.

(6) Every contestant must certify he has not been employed as a commercial or government radio, Morse or cable operator in the last year. This is strictly an amateur contest. The following exceptions, however, shall be eligible:

(a) Holders of commercial licenses without experience under same. (b) Such holders ('phone licensees or technical attendants) whose duties have not been telegraph operating within one year.

The transmitting stations will each send V's ten minutes before scheduled times below. All amateurs are requested to note the frequencies listed and try to cooperate by keeping silence on these channels during copying bee transmissions. Write down just what you hear. Send in all you get so you receive credit and we can send you the official texts for examination.

—F. E. H.



Station	Frequency	E.S.T.	C.S.T.	M.S.T.	P.S.T.
W1AW (W. Hartford)	1800/3800/7150/14254 kc.	9:15 P.M.	8:15 P.M.	7:15 P.M.	6:15 P.M.
W2AYN (New York)	7290 kc.	9:15 P.M.	8:15 P.M.	7:15 P.M.	6:15 P.M.
W2KEZ (New York)	3570 kc.	9:15 P.M.	8:15 P.M.	7:15 P.M.	6:15 P.M.
W6AM (Long Beach)	14306 kc.	10:15 P.M.	9:15 P.M.	8:15 P.M.	7:15 P.M.
W9UZ (Chicago)	7003 kc.	10:15 P.M.	9:15 P.M.	8:15 P.M.	7:15 P.M.
W9BAZ (Louisville)	3670 kc.	10:15 P.M.	9:15 P.M.	8:15 P.M.	7:15 P.M.
W6AM (Long Beach)	7250 kc.	11:15 P.M.	10:15 P.M.	9:15 P.M.	8:15 P.M.
W6CIS (W6ZF) (San Francisco)	3501 kc.	11:15 P.M.	10:15 P.M.	9:15 P.M.	8:15 P.M.
W6AM (Long Beach)	3625 kc.	12:15 A.M. (10th)	11:15 P.M.	10:15 P.M.	9:15 P.M.
W6CIS (W6ZF) (San Francisco)	7280 kc.	12:15 A.M. (10th)	11:15 P.M.	10:15 P.M.	9:15 P.M.
W1AW (W. Hartford)	8001/3800/7150/14254 kc.	12:15 A.M. (10th)	11:15 P.M.	10:15 P.M.	9:15 P.M.

A Practical Television Receiver for the Amateur

General Design Considerations, the Superheterodyne Circuit and Part of the Constructional Details

By C. C. Shumard*

With regular television programs scheduled to start with the opening of the World's Fair at New York, this description of a modern television receiver should have special interest to amateurs, especially those living in metropolitan areas. If the circuit diagram looks formidable, take heart from considering that the average amateur transmitter circuit, if drawn complete with power supplies and control wiring, would be a fearfully complicated affair. Simplicity comes with dissecting and grouping—which the author does in this article, the second of the series inaugurated in October QST.

IN a previous issue of *QST*,¹ Mr. J. B. Sherman has described a scanning unit employing electrostatic deflection. The television receiver to be described here has been designed to operate with a scanning unit of the electromagnetic or electrostatic type, the choice depending on the type of cathode-ray tube or Kinescope to be employed. Provision is also made for simultaneously supplying sound transmissions from the converter plate circuit of this receiver to the antenna-input circuit of an all-wave or suitable short-wave receiver. This auxiliary receiver for sound reproduction must be capable of tuning to about 30 meters, or 9.75 Mc.

Several views of the television receiver chassis and the low-voltage power-supply unit are

shown in the accompanying photographs. The schematic diagram of the receiver is shown in Fig.

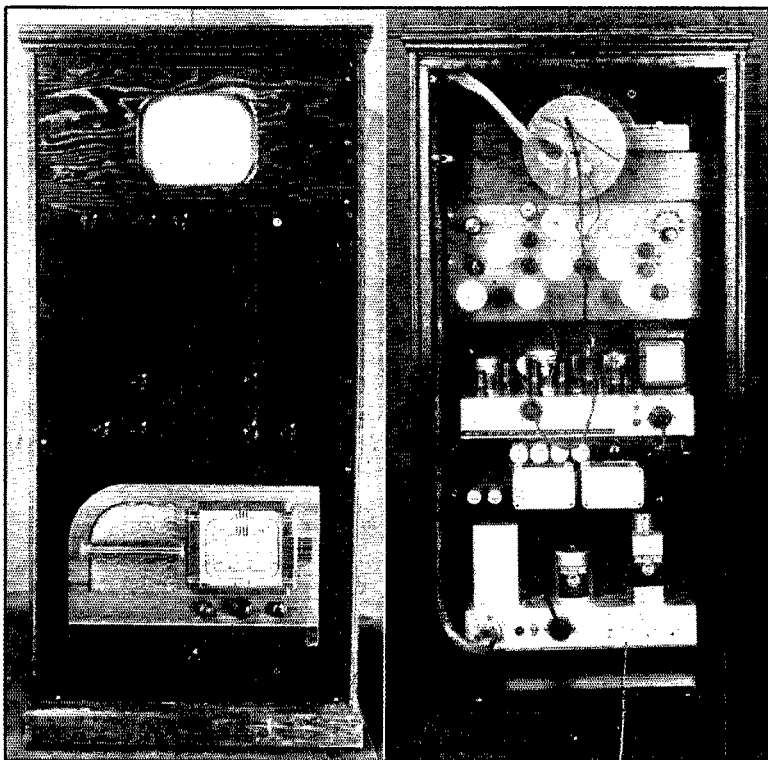

FRONT AND REAR VIEWS OF THE EXPERIMENTAL TELEVISION RECEIVER

The midget receiver set in the panel at the bottom is a standard all-wave broadcast set used as an i.f. amplifier for the sound channel. The units described in this article are the power supply (second from bottom) and the video receiver (fourth from bottom). A magnetic-deflection type Kinescope, with associated circuits, is shown in this set-up, but the receiver may also be used with the electrostatic-deflection circuits given in Part I of this series, with changes to be described in a subsequent article.

* RCA Manufacturing Co., Inc., Harrison, N. J.
¹ Sherman, "Building Television Receivers with Standard Cathode-Ray Tubes," *QST*, October, 1938.

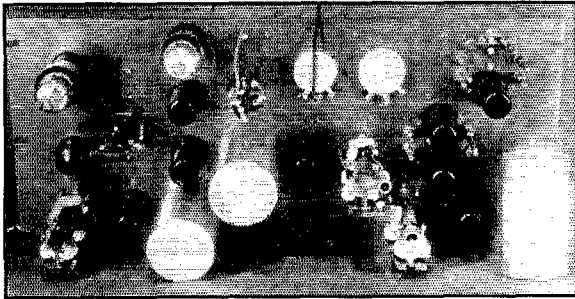

REAR VIEW OF THE RECEIVER WITH SHIELDS REMOVED TO SHOW CONSTRUCTION OF COUPLING UNITS

The receiver is assembled on a relay-rack panel which mounts vertically in the cabinet shown in another photograph.

2. It should be stated at once that although the circuit itself seems to be somewhat complicated, it actually should present no insurmountable problems to the amateur set-builder who has had practical experience in building short-wave or ultra-high-frequency superheterodyne communication-type receivers. As the photographs show, the receiver itself is not as formidable appearing as the schematic circuit.

Limitation of space precludes much theoretical discussion; in addition, information of this type has been well covered in many previous papers.² However, a brief, general discussion of the various parts of the receiver is desirable in order to explain their functions.

In general, the television receiver is quite similar to an ordinary superheterodyne, with variations and additions. In this particular set are included one r.f. stage, a mixer, three i.f. stages, a combination detector and background-control stage, and one video stage. The video stage corresponds to the first audio stage in a communications receiver, except that it feeds the picture or video signal, after it has been demodulated by the diode detector, to the control grid of the Kinescope. Also included are the high-frequency oscillator, the "sound buffer" the "sync separator" and the a.g.c. amplifier. The tube and circuit arrangement is chosen to provide good selectivity, sensitivity, and fidelity, using parts which are readily available to or makeable by the amateur constructor. Because of the band-switching, or rather, "channel-switching" design of the r.f. circuits, the receiver can be tuned to any one of three separate television channels between 40 and 60 megacycles. Thus, when several television stations come on the air in that frequency range, the receiver will not be limited just to one station. Automatic gain control is provided to take care of different receiving

² See Bibliography. (Also M. P. Wilder, *QST* December, 1937, January and February, 1938—EDITOR.)

locations at various distances from the transmitter, and of various signal strengths from different transmitters. There is, of course, little need for a.g.c. on the ultra-high frequencies, so far as fading is concerned.³

A reference to the block frequency chart of Fig. 1 will be of assistance in understanding the operation of various portions of the receiver, as well as of individual circuit components. A typical television signal, with the accompanying sound channel, is shown at A, B, and C. This type of television signal is like that which is being transmitted by the NBC's experimental station from the Empire State Building in New York City. It is

in accord with the television transmission standards as recommended by the Radio Manufacturer's Association. The video carrier frequency is 46.5 megacycles, with upper and lower sidebands (picture modulation) extending to 49 Mc. and 44 Mc. The sound carrier frequency is 49.75 Mc., which is 750 kilocycles away from the upper sideband of the video carrier.

The high-frequency oscillator (Type 6J5) operates at 59.5 megacycles. Because the i.f. stages are tuned to respond only to the upper sideband of the video carrier (section B of Fig. 1) and to the sound carrier (C), the output of the i.f. stages corresponds to E and F of Fig. 1. The i.f. band width shown is 10.5 to 13 megacycles. Because the difference between the video carrier and sound carrier frequencies is 3.25 Mc. and because some separation between the two must be provided, a video band about 2.7 Mc. wide has been maintained throughout the receiver. This is sufficient to provide good picture detail. After the i.f. signal (E) is demodulated by the 6H6 diode detector (V_8), the video signal (G) is applied to the video amplifier (V_9). The i.f. sound

³ When fading is present, as in the case of long-distance transmission through refraction in the lower atmosphere or, less frequently, in the ionosphere, frequency discrimination usually causes the picture quality to be considerably impaired.—EDITOR.

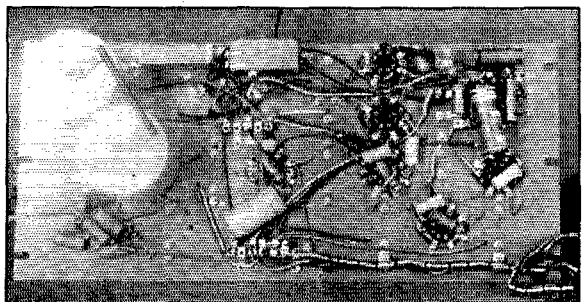

FRONT VIEW OF THE RECEIVER

This side faces the front of the cabinet. The two cans at the left contain the r.f. circuits, with frequency-changing switches ganged together.

carrier (F) is demodulated and reproduced as (H) in the auxiliary short-wave receiver previously mentioned.

Included in the modulation of the video carrier (B) are two high-amplitude synchronizing signals, which must be properly separated from the video modulation and applied to the sync amplifiers (in the scanning unit) so that the scanning of the Kinescope screen will be correctly synchronized with the scanning circuits of the transmitter. The synchronizing signals are obtained from the output of the video amplifier by means of the 6F8G sync separator (V_{10}).

The video amplifier (V_9) supplies the video signal voltage to the control grid of the Kinescope, for the purpose of modulating the brilliance of the spot on the Kinescope screen as it scans the picture. The polarity of the potential changes on the Kinescope grid *must correspond* to the character of the video modulation at the transmitter. This modulation is such that an increase in carrier amplitude corresponds to black on the subject picture. Therefore, the Kinescope grid must be made to swing more negative as the video carrier increases in amplitude, and less negative as the carrier amplitude decreases. Otherwise, the received picture will correspond to a photographic negative rather than to a positive. The second-detector circuit and the number of video stages employed must be properly chosen, due to the fact that each video stage acts as a polarity reverser.

In this receiver, the detector arrangement is such that a positive potential (with respect to ground) is applied to the grid of the first video stage. Therefore, an odd number of video stages is required (one or three). The gain obtained from the i.f. stages and from the 1852 video amplifier is sufficiently high so that only one video stage is needed (V_9). Because slowly shifting or "low-frequency" scenes must be transmitted, direct coupling is used between the detector and V_9 and between V_9 and the Kinescope grid.

The high-amplitude synchronizing voltages included with the video modulation at the output of V_9 are also applied to the Kinescope grid. In time sequence, they occur at the ends of the vertical and horizontal scanning lines. Thus, for the duration of each synchronizing impulse, the Kinescope grid is caused to go sufficiently negative to make its potential below the grid bias value corresponding to black. Therefore, the synchronizing signals do not show on

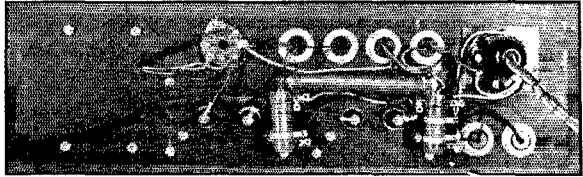

FRONT SIDE OF THE POWER SUPPLY

This unit also mounts vertically; a rear view is shown in the photograph of the complete receiver.

the received picture because they are, in effect, "blacker than black."

VIDEO AMPLIFIER

A peak voltage of approximately 20 volts applied to the grid of Kinescope Type 1800 is required to swing the Kinescope from full brilliance to below cutoff, or to "blacker than black." A plate load of 2500 ohms, properly compensated with inductance to take care of the 2.7-Mc. band width, is employed in the video stage. A peak signal input voltage of about 1.0 volt is necessary to develop the required 20 volts over the desired video band.

DETECTOR

The detector load must be kept low and its capacitance effect must be compensated for, in order to pass the video frequencies. This compensation is accomplished by means of inductances L_{21} and L_{22} (Fig. 2). Only one diode unit of the 6H6 (V_8) is employed for the detector. With the detector-diode load (4300 ohms) employed and at the required output level of about 1.0 peak volt, the voltage drop in the diode is about 0.5 volt. Therefore, an i.f. input of approximately 1.5 peak volts is needed.

The use of only one diode unit as a detector helps to limit the capacitance and resistance load on the output of the last i.f. stage, and permits the other diode unit to be used to bias the Kinescope beyond cut-off while the Kinescope and the other tubes are heating, thus keeping the screen dark.

With single sideband i.f. operation, some undesirable overlapping of the low video-frequency modulation results. This necessitates a reduction in the i.f. gain on the high-frequency side of the i.f. band. The reduction in gain should be of the order of 40 percent.

I.F. AMPLIFIER

The choice of intermediate frequency is necessarily a compromise between conflicting requirements. A high ratio of i.f. "carrier" to video

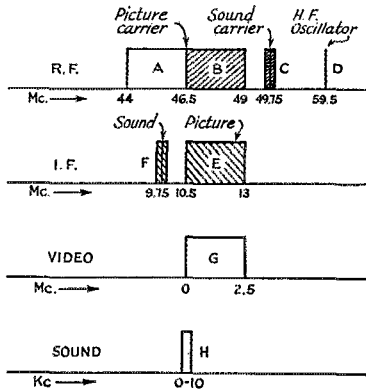

FIG. 1.—BLOCK FREQUENCY DIAGRAM FOR THE VIDEO RECEIVER

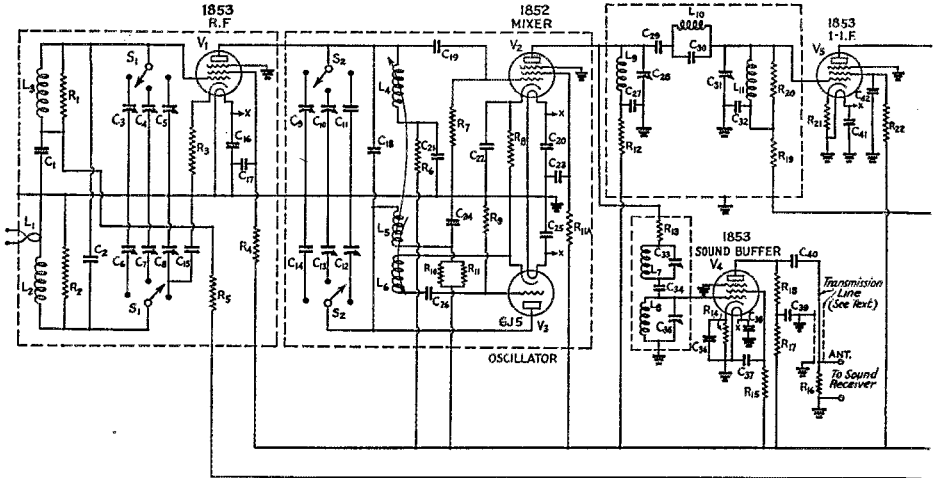

FIG. 2—CIRCUIT DIAGRAM OF THE RECEIVER AND POWER SUPPLY

- C₁, C₁₇, C₁₉, C₂₁, C₂₂, C₂₃, C₂₄—500- μ fd. mica (Micamold OM900).
 C₂—5- μ fd. mica (Micamold GM800).
 C₃, C₄, C₇, C₈, C₉, C₁₂—20- μ fd. air trimmer (RCA-Victor 12884).
 C₅, C₆, C₁₀, C₁₃—12- μ fd. air trimmer (RCA-Victor 12714).
 C₁₁, C₁₄—Value depends on frequency desired.
 C₁₅—10- μ fd. mica (Micamold GM 800).
 C₁₆, C₂₀, C₂₅, C₃₂, C₃₆, C₃₈, C₄₁, C₄₈, C₄₉, C₅₆, C₅₇, C₅₄, C₆₆—0.01- μ fd. paper, 400-volt (Solar S-0219).
 C₁₈—1- μ fd. (Micamold GM800).
 C₂₈—40- μ fd. mica (Micamold GM-800).
 C₂₇, C₃₇, C₃₉, C₄₀, C₄₂, C₄₃, C₅₀, C₅₁, C₅₈, C₅₉—0.01- μ fd., 400-v. paper (Aerovox).
 C₃₈, C₃₁, C₃₃, C₃₅, C₄₄, C₄₇, C₅₂, C₅₅, C₆₀, C₆₃—25- μ fd. variable (Hammarlund APC-25).
 C₂₉, C₃₄, C₄₅, C₆₃, C₆₁—560 μ fd. (RCA-Victor M39, No. 12537).
 C₃₀, C₄₆, C₅₄, C₆₂—18 μ fd. (See note*) (RCA Victor M12, No. 12722).
 C₆₅, C₆₉—4- μ fd. electrolytic, 450 v.

- (Aerovox ST-855).
 C₆₇—0.25- μ fd. (min.), 400-v. paper.
 C_{67A}—1- μ fd., 400-v. paper.
 C₆₈, C₇₀—0.05- μ fd., 400-v. paper.
 C₇₁—10- μ fd. electrolytic, 25-v. (Sprague TA-10).
 C₇₂—0.05- μ fd., 200-v. paper.
 C_{72A}—50- μ fd. electrolytic, 25-v.
 C₇₃—2- μ fd. (min.), 200-v. paper.
 C₇₄—8- μ fd. electrolytic, 450-v. (Sprague PTM-8).
 C₇₆, C₇₈—50- μ fd. electrolytic, 25-volt (Mallory RS-200).
 C₇₇, C₇₈—8- μ fd. electrolytic, 450-v.
 C₇₉, C₈₀—16- μ fd. electrolytic, 450-v.
 R₁, R₃₄—3000 ohms, 0.5-watt.
 R₂, R₇, R₁₇—2000 ohms, 0.5-watt.
 R₃, R₂₁, R₂₆, R₃₁—68 ohms, 0.5-watt.
 R₄, R₁₀, R₁₁, R₁₅, R₂₂, R₂₇, R₃₂, R₅₄—30,000 ohms, 0.5-watt.
 R₅, R₁₉, R₂₄, R₂₉, R₄₉—20,000 ohms, 0.5-watt.
 R₆, R₈, R₁₂, R₁₈, R₂₃, R₂₈, R₃₃, R_{41A}, R₄₃, R₄₄, R₅₃, R_{54A}—1000 ohms, 0.5-watt.
 R₉, R₄₇—10,000 ohms, 0.5-watt.
 R_{11A}—150,000 ohms, 0.5-watt.
 R₁₃, R₅₆—15,000 ohms., 0.5-watt.
 R₁₄—200 ohms, 0.5-watt.

- R₁₆—50 ohms, 0.5-watt.
 R₂₀, R₂₅, R₃₀—2500 ohms, 0.5-watt.
 R₂₅, R₅₁—200,000 ohms, 0.5-watt.
 R₃₆—4300 ohms, 0.5-watt.
 R₄₇—50,000 ohms, 1-watt.
 R₃₈—50,000 ohms, 0.5-watt.
 R₃₉, R₄₀, R₄₁—5000 ohms, 0.5-watt.
 R₄₂—5000 ohm potentiometer.
 R₄₅, R₅₂—20,000 ohms, 1-watt.
 R₄₆—3 megohms, 0.5-watt.
 R₄₈—0.5 megohm, 1/2-watt.
 R₅₀—50,000 ohms, 0.5-watt.
 R₅₅—25,000-ohm potentiometer.
 R₅₇—20 ohms, 1-watt.
 R₅₈—100-ohms, 1-watt.
 R₅₉—5000 ohms, 25-watt.
 R₆₀—340 ohms, 10-watt.
 L₁ to L₂₃—To be described in Part III.
 L₂₄, L₂₅—20-henry, 200-ma., 100-ohm filter choke.
 T₁—Power transformer (Thordarson Type T-13R16).
 S₁, S₂—Mallory-Yaxley selector switch No. 3243-J.
 * Value of these condensers is critical.
 All fixed 1/2 and 1-watt resistors are I.R.C. Type BT.

band-width assists in obtaining a flat i.f. response over the desired range of video frequencies. A low intermediate-frequency permits greater gain per stage and better stability. The i.f. "carrier" value chosen is 13 Mc., which seems to represent a reasonable compromise for both band-width and gain considerations.

Ordinary i.f. transformers are not employed, because the type of i.f. response curve desired can better be obtained with coupling networks consisting of inductance, capacitance, and resistance. These coupling units, as well as those used in the r.f., mixer, h.f. oscillator, and sound buffer stages, are "hand tailored". Complete design data on the various units will be given later, in Part III of this paper.

The i.f. gain per stage is about 5 to 8 for a pass-band of 13.0 to 10.3 Mc. Three i.f. stages give sufficient overall gain.

MIXER AND OSCILLATOR

An 1852 is used as the mixer (V_2) in conjunction with a 6J5 h.f. oscillator (V_3). Inductive and capacitive coupling is employed between the oscillator plate coil (L_5) and the r.f. amplifier plate coil (L_4), which is capacitance coupled to the No. 1 grid of the mixer in conventional manner.

The oscillator is operated at a higher frequency than the video carrier in order to maintain less coupling discrimination throughout the wide video sideband range. For reception of the transmitter chosen as an example for this discussion, which is assumed to have a video carrier of 46.5 Mc. (see Fig. 1), the oscillator frequency is 59.5 Mc.

R.F. AMPLIFIER

The grid circuit of the r.f. amplifier stage consists of a band-pass network (L_2 , L_3 and associated

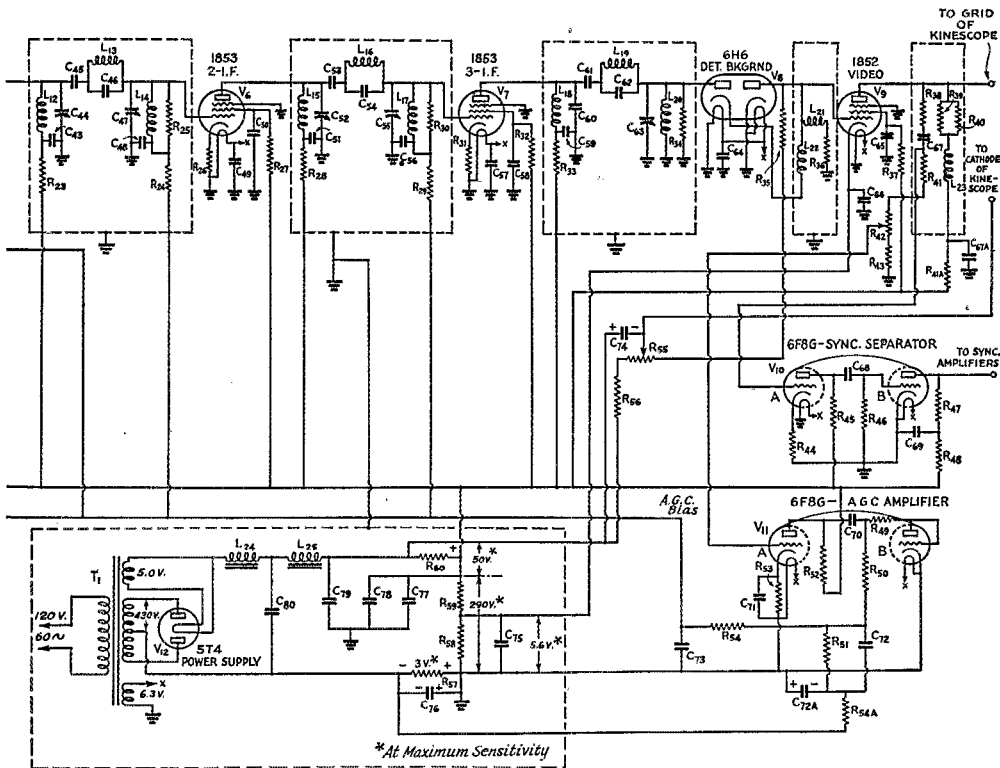

circuits) tunable from about 40 to 60 megacycles, with a pass band of nearly 3 Mc. The various tuned circuits, including the oscillator circuit, are fixed-tuned by means of adjustable, plunger-type, air condensers. Because there is not enough room in the oscillator-mixer shield can for more than four of the plunger-type condensers, C_{11} and C_{14} (not included in the present receiver) can be of the midget compression type, if the third channel is to be covered. A single-turn coil (L_1) couples the antenna to the grid circuit. This coil has a grounded center-tap, so that it is suitable for use with a doublet antenna employing a twisted-pair transmission line. The double-tuned input circuit, correctly adjusted, provides the familiar double-humped response curve of two over-coupled circuits and thus improves the overall band-pass characteristics of the entire receiver.

The r.f. amplifier plate circuit consists of a single, broadly-resonant tuned circuit supplementing the grid network. The output of the r.f. stage is capacitance-coupled to the No. 1 grid of the mixer tube.

The adjustable plunger-type tuning condensers are ganged for channel switching by means of switches S_1 and S_2 . Only one set of condensers need be adjusted if reception of only one television station is contemplated. It is highly desirable and economical, however, to make provision for the two additional channels, in order to save

the trouble and work involved in rebuilding the "front end" of the set at a later date.

SOUND BUFFER

The "sound buffer," employing a Type 1853 (V_4), receives the i.f. signal with the sound modulation directly from the plate of the mixer tube. A tuned network (L_7 , L_8 , and associated circuit) helps to filter out the low-frequency end of the video i.f. carrier (approximately 10.5 Mc.) while it passes the sound i.f. carrier (9.75 Mc.). An important function of the sound buffer tube is to prevent interaction between the high-frequency oscillator (tuned to about 10.2 Mc.) of the sound receiver and the i.f. circuits of the video receiver.

The output of the sound buffer tube is resistance-capacitance coupled to a 50-ohm coaxial transmission line (see Fig. 2). The transmission line consists of a length of No. 18-16/30 "Shielded Nu-Cor," made by the Cornish Wire Co., New York City. Any other type of shielded wire of similar characteristics can be employed. The transmission line is terminated at the auxiliary short-wave "sound" receiver with a 50-ohm resistor, the leads from which go to the antenna and ground terminals of the sound receiver. The sound i.f. carrier in this example is 9.75 Mc., to which frequency the sound receiver must be tuned. This frequency setting does not have to be

(Continued on page 72)

What the League Is Doing

League Activities, Washington Notes, Board Actions—For Your Information

Election Results When the Executive Committee of the A.R.R.L. met on November 2, 1938, to examine nominations in connection with this year's elections for director and alternate director, it found itself faced with a number of unexpected situations resulting from the newly adopted directorship qualifications embodied in By-law 12. The upshot is that elections are being held in four divisions, while in four others the incumbents are either returned to office or single nominees have been declared elected in the absence of eligible opponents.

Taking up the non-voting divisions first, in the Central Division, there were initially six nominations; two nominees withdrew, one of the petitions was invalid and none of the remaining nominees was found eligible under the provisions of By-law 12. As a result, Director R. H. G. Mathews continues in office, under the terms of By-law 21. In the case of the alternate director, there were two valid nominations but only one of the candidates was found eligible. In consequence, E. W. Kreis, W9HRM, the only eligible nominee, was declared elected. Mr. Kreis is an old-timer, having been in the game since 1911. His original call was 9EJ.

In the Hudson Division, the incumbent was found to be the only one eligible of two nominees for the directorship. Director Kenneth T. Hill, W2AHC, was therefore declared reelected. The present alternate director, Robert M. Morris, W2LV, was declared reelected by the committee in the absence of other nominations.

In the Roanoke Division, the two incumbents—Director H. L. Caveness, W4DW, and Alternate Director J. Frank Key, W3ZA—continue in office in the absence of competition. Apparently the Roanoke Division has no complaints concerning its present administration!

In the Southwestern Division, Director Charles E. Blalack, W6GG, continues in office in the absence of an eligible opponent. Although not himself nominated, John E. Bickel, W6BKY, continues as alternate, the only valid nominating petition for the post having been for an ineligible candidate.

Elections are being held in the remaining divisions. In the case of the New England Division the eligibility mortality was not so great, but one candidate for director failing to qualify. Three other nominees are competing for the directorship: Clayton C. Gordon, W1HRC, Percy C. Noble (the incumbent), W1BVR, and Dr. R. W. Woodward, W1EAO. There were

three nominations for alternate director, but two were ineligible, so Russell Bennett, W1GTN, was declared elected.

The Northwestern Division has the unique distinction of being about the only division to offer none but eligible candidates. There are three in the directorship race: Stanley J. Belliveau, W7AYO, Ralph J. Gibbons (the incumbent), W7KV, and A. L. Smith, W7CCR. There are three candidates for alternate director, as well: Niilo E. Koski, W7LD; W. L. Miller, W7AAN, and W. N. Wintler, W7KL.

In the Rocky Mountain Division, the present director, Edward C. Stockman, W9ESA, decided not to run, so the issue lies between Glen R. Glasscock, W9FA, and C. R. Stedman, W9CAA. There was but one nominee for alternate, so Charles W. Duree, W9EII, was declared elected. There was one invalid directorship petition, received after the close of nominations.

The present director of the West Gulf Division—Wayland M. Groves, W5NW—also decided not to run, leaving the contest to David H. Calk, W5BHO, and Wm. A. Green, W5BKH. The only nominating petition for alternate director was for Wm. H. Burt, W5BRC, who was declared elected. There was one invalid directorship petition, received after the close of nominations.

The elections will close on noon of December 20th, and that afternoon the Executive Committee will constitute itself a Committee of Tellers to count the ballots. The results will be announced in February *QST*, of course, and there will be special broadcasts over W1AW that night and through the week so that members may acquaint themselves with the results.

'Phone Frequencies Do you remember the *QST* poll, asking members whether they favored assigning the new frequencies 2000-2050 kc. to 'phone when our 1715-2000 band is shifted to 1750-2050? Well, 78 per cent of the replies were in favor, whereupon our Board of Directors immediately asked the F.C.C. to make this alteration at the time the band is moved. We are pleased to report that F.C.C. has assented to this request and that the new 'phone band will read 1800-2050, an increase of 50 kc. for 160-meter 'phone. In Canada the band will read 1775-2050. This actual shift is expected to take place about the first of the year; watch for further announcements.

Our new emergency regulation mentions 1975-

2000 kc. as one of the emergency calling channels. It is supposed to be on the edge of the 160-meter 'phone band. When this band is shifted, as mentioned above, this emergency calling channel will also be moved to the last 25 kc. in the band, 2025-2050 kc.

— . . . —

Deputy Inspectors The A.R.R.L. Board asked the F.C.C. to establish an arrangement whereunder selected amateurs would be deputized as special additional inspectors for the amateur bands. The Commission, although highly sympathetic, has advised the League that the terms of the Communications Act of 1934, as well as the statutes prohibiting the acceptance of voluntary services, prevent the deputizing of amateurs in the manner suggested. However, the Commission has invited us to confer with them in an effort to work out a procedure by which amateurs may be of more assistance in the detection and prosecution of illegal radio operation, and there may yet be news on this subject.

— . . . —

Puerto Rican News The F.C.C. has drawn one of its 125-mile circles around its new district office at San Juan, P. R., effective December 1st. After that date, all amateur applicants in Puerto Rico will have to appear at the San Juan office in person for amateur examination for Class B license, and there will be no more Class C. Moreover, all existing holders of Class C licenses in Puerto Rico are notified that they must appear at San Juan and qualify for Class B before April 1, 1939, or forfeit their Class C licenses.

The above arrangements are confined to Puerto Rico and do not extend to the Virgin Islands, where Class C will continue to be available.

— . . . —

Island Prefixes We are pleased to report that the F.C.C. has acceded to a request by the A.R.R.L. that special identifying prefixes be used in amateur calls in regions outside of the United States, to distinguish one region from another. Many countries, notably Great Britain and France, have long had such an arrangement but American amateurs have never been able to distinguish between our far Pacific possessions and Hawaii, between Puerto Rico and the Virgin Islands, etc. The new system will make that possible and will be of immense utility to us in identifying isolated stations, especially in emergencies of any nature. DX men will be interested to know that the new procedure will make possible the recognition of different island groups as counting separately for the DX Century Club. Existing amateurs in these outposts

have been invited by F.C.C. to file applications to modify their calls in accordance with the new list. This list is not yet definite and we emphasize that the tabulation below is not entirely reliable; we publish it simply because we know you are interested and it is our belief (but not certainty) that it will take this form:

- K4 —Puerto Rico
- KB4—Virgin Ids.
- K6 —Territory of Hawaii
- KB6—Guam
- KC6—Wake group
- KD6—Midway Ids.
- KE6—Johnston Id.
- KF6—Baker Id., Howland Id., Am. Phoenix Ids.
- KG6—Jarvis Id., Palmyra group
- KH6—Am. Samoa
- K7 —Ter. of Alaska (including Pribilof Ids.)

— . . . —

The New Regs We think we have a pretty snappy bunch of new regulations. Of course they are not perfect and there will be some things in them you do not like. But if you find items about which you want to howl in anguish, you should know of some of the proposals that were under consideration and which were rejected because of A.R.R.L. opposition. The list of things avoided includes reduction of power; extending quiet hours from 6 P.M. to midnight; language that would kill our Official Broadcast System and code lessons; prohibition of more than one portable; requirement of good character in licensees and denial on such grounds as the known moral turpitude of the applicant; requirement of the personal ownership of the apparatus employed; specially-reduced power for 'phone stations in apartment houses; requiring consent of landlords before licensing stations in apartment houses; and a great many more of the same sort. Almost any redrafting involves some tightening up. We just thought that if you found any of the items distasteful, it would be illuminating to consider some of those we ducked because of A.R.R.L. participation. As another example, the requirement of frequency-measuring means was first proposed to be applied only to stations working within 10 kc. of the edge of bands. A.R.R.L. opposed that as unfair discrimination against certain amateurs and an impracticable procedure. The Commission was insistent that something be done to improve the frequency-observance situation. So a compromise was reached, requiring all stations to employ means independent of the frequency control of the transmitter, but only necessarily of accuracy sufficient to insure operation within the bands. Taken by and large, we have the feeling that our new regs are superior to those of any other service.

Results, 1938 A.R.R.L. Field Day

FROM the standpoint of operator interest the A.R.R.L. Field Day is now definitely on a par with the DX and Sweepstakes Contests. There were 1060 participants (exclusive of YL's, YF's, junior operators, etc.) in the Sixth A.R.R.L. Field Day, June 11th and 12th, 1938!! Ninety-four groups, an aggregate 764 individuals, went into the F.D. in the name of their respective club organizations. 296 additional participants took part as members of ninety non-club groups.

The bands were alive with portable stations. The percentage of portables worked by participating stations ran usually high, in some cases exceeding 50 per cent of all contacts established.



CHOW AT W4NC-4

One of the joys of Field Day . . . eating! Some of the Winston-Salem Amateur Radio Club gang gather around the skillet and coffee pot. Left to right: W4RA (sitting); W4CFR, W4WX, P. W. Blum and W4BOH. (Photo, The Journal & Sentinel, Winston-Salem, N. C.)

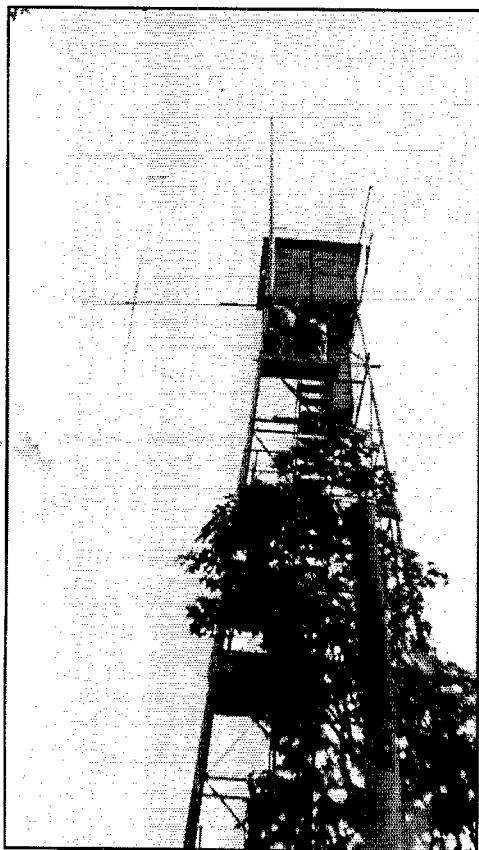

THE W2AIW-2 56-MC. LOCATION

Seventy-three of the Jersey Shore Amateur Radio Association's 165 contacts at W2AIW-2 were made on 56-Mc. from inside a fire tower of the New Jersey State Forest Service. The tower is about 60 feet high, with the base at the top of a hill about 250 feet above sea level and well above the surrounding country for a distance of about 30 miles! The antenna may be seen suspended from the tower at the left.

That fact, perhaps, is the best word picture we could offer to describe the intensity of portable operation during that not-to-be-forgotten weekend in June.

The steady increase in Field Day activity from year to year is an encouraging sign. It indicates increased interest in the construction and operation of auxiliary equipment and procurement of auxiliary power supplies . . . definite steps toward emergency preparedness. Let us continue the forward-looking march!

We wish to thank all concerned for the splendid reports received. Would that we had the space to present them all in full! But space limitations permit us to hit only the highlights and representative portions of various accounts. Thanks also for the scores of photographs; here again we can present but a comparative few of these and have endeavored to pick the ones best suited to reproduction, and to show several phases of F.D. participation, regardless of size of score. And, Oh, Boy! did some of the scores have "size"!

The Egyptian Radio Club, using the club call W9AIU on Chouteau Island, across the Mississippi River from the northern city limits of St. Louis, Mo., established an all-time high in Field Day scores—3708—and led the F.D. for the second consecutive year. 317 contacts were made on 1.75-Mc. 'phone and 3.5-, 7- and 14-Mc. c.w. Contacts per band were 41 on 1.75, 28 on 3.5, 197 on 7, 51 on 14 Mc. 85 of the 317 QSO's were with other portable stations. A separate transmitter was available for each band, simultaneous operation on the four bands made possible by efficient

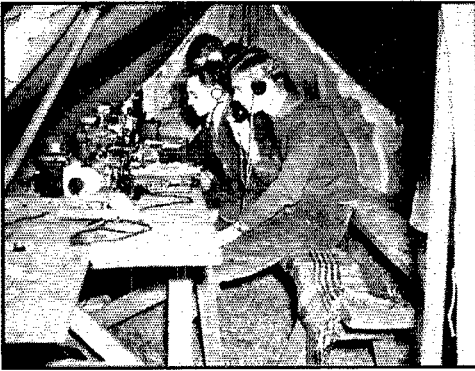

W8KG-8 IN ACTION

The Buckeye Short Wave Radio Association of Akron, Ohio, operating W8KG-3, placed twelfth among club groups. Here we see W8OQJ at the mike with W8GCI assisting; 112 stations were worked, 52 on 3.5 Mc., 46 on 56 Mc. and 14 on 7 Mc.

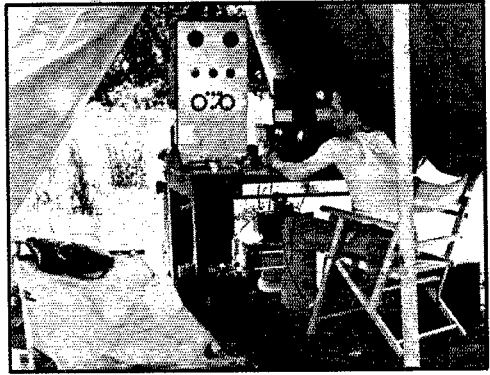

W3AIR-3

The Trenton Radio Society operated two complete units under the call W3AIR-3 from the grounds of the State Police Headquarters, Wilburtha, N. J. This is Unit "B" with W3AIR at the controls. The transmitter is crystal controlled with P.P. 807's in the final.

each click filters and proper placing of antennae. Each c.w. transmitter consisted of the Reinartz tetrode oscillator circuit using 802 tubes at 12 to 18 watts input. 'Phone operation started using a 6C5 Pierce oscillator and 6L6 final, modulated by a 6L6, with 10 watts input. This rig was later replaced by a three stage crystal job using an 807 final running at 15 watts input; modulation equipment for this outfit was a 6N7 in Class B. Seven separate receivers were used. Antennas consisted of a half wave end fed for 1.75 and 3.5 Mc., two 7-Mc. doublets placed at right angles using EO1 cable for feeders, and two 14-Mc. doublets similar to the 7-Mc. wires. Antennas were supported by makeshift masts felled in a nearby forest. The masts were placed in an open field adjacent to the deserted farm building in which the equipment was housed. Power supply

was a 1500-watt gasoline engine driven 220 volt, three phase alternator. Step down transformers were used on each phase to obtain 110 volt 60 cycle a.c. The alternator was placed 200 feet from the receivers to minimize noise. The generator provided power for lights, soldering iron, etc., as well as station operation. A crew of 19 operators participated at W9AIU-9. We have explained the Egyptian Radio Club's set-up at considerable length since such superlative performance rates detailed explanation. Congratulations, E.R.C.!

The Frankford Radio Club, W3BKX-3, is in second place with 2241 points . . . 156 contacts on 3.5, 7 and 56 Mc. 53 per cent (83) of all contacts at W3BKX were with other portables! Transmitter used on 3.5 and 7 Mc. was a 6L6 crystal and e.c.o. driving an 809, with under 20 watts input from a gasoline driven power plant.

W6GTM, MONUMENT BEACH, CALIF.

Left to right: W6ISG, W6BBR and W6GTM . . . operated W6GTM-6 in a tent on the beach border of the United States and Mexico. They used one of the wires of the International Fence for receiving antennae!



SOME FUN, THESE F.D.'s!

VE2BV is apparently enjoying his participation at portable VE2KH, Dunany, Que. The rig, 6L6 c.o.-6L6 amplifier, 12 watts input, received its power from a 6-volt Genemotor. The receiver was a 58 r.f. and 58 detector.



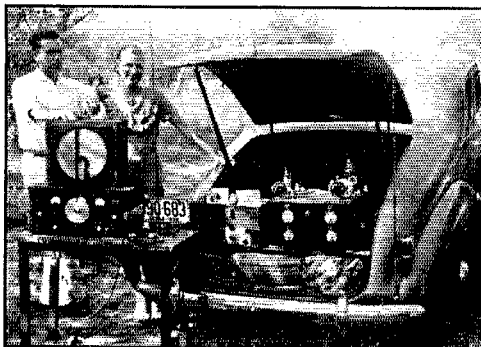

A "MR. & MRS." FIELD DAY UNIT

W5MS and XYL W5BZW, together with W5DVK, operated W5MS-5 at Lake Corpus Christi, near Mathis, Texas; 69 contacts were made on 7 and 14 Mc.

Receiver was operated on B batteries. Antenna was 132 foot zepp fed. Five operators did all the operating. FB, Frankford!

A close third is W2AIW-2, the Jersey Shore Amateur Radio Association . . . 2178. Operation was on five bands, as follows: 1.75 Mc. (3 contacts); 3.5 Mc. (42); 7 Mc. (30); 14 Mc. (17); 56 Mc. (73). 67 of the total 165 contacts were with other portables. 56-Mc. operation from a fire tower of the New Jersey State Forest Service was particularly successful. Simultaneous operation on three bands worked well. The 3.5-Mc. and 7/14-Mc. transmitters were located in a tent about 130 feet from the base of the tower. The 1.75-Mc. (and later the 7/14-Mc.) transmitter was located in a large tent 260 feet from the tower. All power was obtained from 110 volts a.c. furnished by three gasoline driven generators. Input to all rigs was 20 watts or less. The "hi"-light of the whole affair for the W2AIW-2 gang occurred about midnight when the log sheet of the 56-Mc. gang, containing the entire evening's work blew out the window of the tower and sailed far away over the tree tops into the blackness of the night! A few minutes later a shower arrived and the rain came down for two hours. It was thought the log would never again be seen. However, a searching party set out at daybreak and by 6:00 A.M. the sheet had been located about a quarter of a mile away, very wet but perfectly readable.

The York Road Radio Club, veteran of Field Days, placed fourth this year with a score of 2070 . . . 147 contacts (49 per cent of them portable-to-portable). Five units operated simultaneously on four bands under the call W3QV-3. Bands used were 3.5, 7, 14 and 56 Mc., all work being in the "20 watt" class. Once again Y.R.R.C. "returned to the scene of the crime," operating at the location used on previous F.D.'s, Ringing Rocks Park, two miles from Pottstown, Pa. Power supplies included several dynamotors and a 300-watt gas driven a.c. plant. One comment in

particular in the W3QV-3 report is worthy of consideration: "It was proved conclusively that good emergency equipment does get out." And, brother hams, the Field Day is the opportunity to find out just how "good" your equipment is! Be sure to test your equipment next F.D.

Leading the non-club groups and fifth high among all stations is W2DKJ-2, operated in the tower at 40 Wall Street, New York City, by W2DKJ, W2IGK, W2BKU, W2LAH, W2KSKZ and George Wies, ex-W2AHK. The score of 1971 is comprised of 1719 points on 56 Mc. (!) and 252 points on 28 and 14 Mc. Of the 226 total contacts 149 were made on "five meters." Thus does W2DKJ easily retain the title of leading 56 Mc. F.D. station. This new record will be hard to beat.

Top Canadian participant, sixth high among all stations is VE3AJV, the Frontier Radio Club, with eight operators. Operation was on 3.5, 7 and 14 Mc. with a separate 20-watt transmitter for each band. Power was supplied by a 60 cycle 110 volt generator belt-driven from the rear wheel of a '36 V8. This furnished juice for lights, receivers and transmitters. 74 per cent of the 121 contacts were with other F.D. stations . . . score: 1899. Second high VE is VE3KM, the Hamilton Amateur Radio Club . . . 1404.

Dozens of splendid scores were rolled up. The tally of results will show what each participating station accomplished. Whether the score is large or small the comments of Field Day operators are uniform, "We had a swell time and learned plenty about portable/emergency operation." Extracts from the reports of a number of stations follow; we know you will find them interesting. June, 1939, with another big A.R.R.L. Field Day is but six months away. Don't miss it! Get your portable equipment built and in operating condition NOW.

—E. L. B.



A PORTABLE ON WHEELS

W9AEM-9, manned by eight operators, was installed in a truck and operated from Broadview, Ill. A gasoline motor-driven generator supplied power to the transmitter. The receiver was operated from a vibrator power supply. Left to right: W9KRT, W9YZN, W9RHZ, W9AEM, W9LBN (W9FI in truck).

W9DIR had charge of the c.w. encampment and W9RBI the 'phone. Considerable rivalry sprung up between the two groups several weeks before the Field Day and there was a close race for QSO honors. 82 stations were worked on 3.5- and 7-Mc. c.w. and 75 stations on 1.75-, 3.9- and 14-Mc. 'phone. Input was kept at 20 watts on both transmitters. The success of our F.D. participation can be laid to one thing . . . the "Bad Indian" beam. For those who have not worked W9RBI, the Vee beam is three 240-ft. legs spaced 60 degrees apart and fed with three 40-ft. zepp feeders, switching the two outside legs for NS or EW beam. Several insulting gentlemen accused us of running anywhere from 500 to 2000 watts. Hi. Our location was a large cow pasture 4 miles east of Wisconsin Dells, perfectly level country—we couldn't see the gain in this big hill stuff. Hi! A good antenna on clear level ground and boy, you've got something. For our first field attempt we are well satisfied and serve notice on the rest of the country to look out for the D. double-R. C. next year.—*Dells Region Radio Club, W9RBI-9.*

Operation was on all bands, including 56 Mc. and was from the club's permanent portable location in the Palos Verdes Hills. The club has raised two 80-foot towers on a ranch belonging to one of the members, and it is contemplated erecting a clubhouse thereon in the very near future.—*United Radio Amateur Club, W6CL-6.*

Our Field Day activities were a big success in spite of the pouring rain over most of the week-end. We had a 500-watt a.c. generator (real classy) and a 1-kw. rewound Dodge unit furnishing power for two receivers, three transmitters, and sufficient lighting to make operating a pleasure. Both units held up beautifully. We ran the rigs at 20 watts at all times, keeping the voltage drop due to keying at a minimum. We took moving pictures of the activity. Our location was near Clinton, N. Y., at Franklin Springs at a camp which the club has obtained for the year. Fifteen operators took turns at operating.—*Utica Amateur Radio Club, W8AU-8.*

With typical Field Day weather (pouring rain) we got off to a poor start. The main generator broke down necessitating taking the magneto apart. The club was divided into three groups all operating under the call W9SRB-9. The main group was set up in the same abandoned pipe factory used last year. Group 2 was composed of some of the younger fellows who went out Friday morning and set up tents in the Forest Preserve. Group 3 (2 men) used some commercial a.c. and the Club's 300 watt generator the rest of the time. We didn't do much better than last year but watch out for us next year.—*The Northwest Amateur Radio Club, W9SRB-9.*



A 2-KW. A.C.-D.C. EMERGENCY POWER UNIT

The South Hills Brass Pounders and Modulators (Pittsburgh, Pa.) maintain this permanent power supply for emergency use. It is given a good work-out each Field Day. A 4-kw. generator (2 kw. at 85 volt, 60-cycle a.c. and 2-kw. 110-volt d.c.) is driven by a 1927 model Whipper motor mounted on the front half of the car chassis. The chassis is cut to "trailer proportions." The 85 volts a.c. is stepped up to 110 volts by means of a 5-kw. auto transformer. The 110 d.c. is generally used for lighting purposes. Pictured here giving the unit the once-over are (l. to r.) WSPX, WSOFO, W3QV, W8OC and W8QAN

W9YKK-9 operated in a cabin located at the Orchard Grove Tourist Camp, which is owned and operated by W9YGC. If it had rained much harder we probably would have had an "emergency." We all had a fine time and expect to be back again next year. All the praise in the world to the "Pioneer" gas driven generator, and to the Indiana State Police, from whom it was borrowed.—*Monument City Radio Club, W9YKK-9.*

A good time was had by all, even tho' there was nothing to eat but plenty of chocolate cake for the full 24-hour period. We are eagerly looking forward to the 1939 Field Day Contest, at which time we believe we will be able to run up a nice score as we are now working on a portable 'phone-rig as well as increasing the efficiency of the c.w. rig. With this in mind, the 1938 winners had better PREPARE, if they want to REPEAT.—*W4ECI-4.*

Although a large score was not made a swell time was had by all. Three rigs were used: (a) 616-807; (b) 6L6-6L6-T20; and (c) 6L6-T20. Power was furnished by a Homelight 1-kw. generator which ran 30 hours FB. This was our first year and we learned lots, so tell the rest to look out for us next year and no foolin'.—*Bridgeport Amateur Radio Association, W1JHT-1.*

Our transmitters were located in Topanga Canyon, which is about 7 miles North of Santa Monica and about four miles inland from the Pacific Ocean. The gang enjoyed itself very much.—*Mike and Key Club, W6RR-6.*

In spite of the threat of rain we set the outfit up in the open and got going—for one QSO it rained! We covered the junk with a tarpaulin and waited. When it stopped raining we uncovered and proceeded. This starting and stopping for the rain went on until it really started to blow up badly about 9 P.M. so we moved everything except the power plant into W8NXD's car. This we covered with the tarpaulin and everything was lovely from then on. The little Kato power supply outfit sure delivered the goods. We are looking forward to the next F.D.—*W8CUG-8.*

Club members cooperated by bringing in refreshments, etc. for the operators and a good time was had by all. Thirteen operators were on hand during the twenty-six hour test. Change-overs were made regularly, giving all ample time on their shifts. Two operators were at the keys and a log-keeper was on hand at all times. Thus a very systematic layout worked with precision. A large furniture truck housed our outfits making conditions very comfortable. This year was the most successful and enjoyable we have had since

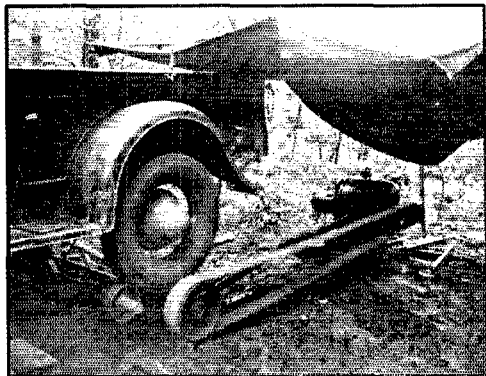

THE BUSINESS END OF W1AAJ-1

This is the method used by the Green Mountain Radio Club to generate power for W1AAJ-1, located on Mt. Pico, ten miles east of Rutland, Vt. The generator was a 20-kva. job, supplying 110 volts, 60-cycle a.c., run by a Ford truck on a treadmill. The truck ran at an average speed of 19 to 20 m.p.h. and, according to the speedometer, covered 568 miles to enable the gang to roll up 1512 points!

our first Field Day four years ago.—*Hamilton Amateur Radio Club, WESKM.*

Members of the *St. Paul Radio Club*, using the new club station call, W9KYC, participated in the Sixth A.R.R.L. Field Day Contest. W9FUZ's trailer coach and transmitter therein were used together with three additional transmitters. The equipment was erected north of the City of St. Paul at Lake Phalen tourist camp. The source of power was a 1,000-watt Onan plant which gave excellent voltage regulation. One transmitter and receiver was operated with a vertical antenna from W9IBD's car and picked up contacts on 14-Mc. 'phone. All transmitters were operated within the limit of 20 watts input.—*W9KYC-9.*

Field Day was for the *Trenton Radio Society* an experience in operating under adverse conditions with thunder storms continually playing tag with our antenna masts. Nevertheless the event was a large success both in regard to the good time enjoyed by all and in regard to the apparatus, which showing the benefit of the experience from three previous field days, performed without the slightest failure. Furthermore, by courtesy of the New Jersey State Police, we placed our station on the grounds of their Headquarters at Wilburtha, N. J. Judging from the favorable comments of our hosts, we won their good will and effectively demonstrated our potentialities as an emergency communication system. No time was available for games and other activities, as had been hoped, but pleasant diversion was had by the frequent exchange of visits with the members of the D.V.R.A., whose F.D. station, W3ZI/3, was located nearby. We are looking forward to next Field Day, when we hope to have three stations on the air continuously with a telephone system between them to prevent duplicate contacts (which were a waste of time this year).—*W3AIR-3.*

Operated from 9:30 p.m. until 5:30 a.m. in car parked in back of the new W1AW station building in Newington, Conn. Used single 6L6 tri-tet with 7-Mc. crystal and doubled to 14,008-ke. . . . input 18 watts. Hooked on to the W1AW 14-Mc. rhombic, giving it the first workout. Results: Two VK's with reports of RST 569x plus, three W5's, three W6's and one W7, all with good reports!—*W8LO-1.*

W5BRX/5 was operated by the *Tulsa Amateur Radio Club* on top of Turkey Mountain, some 10 miles south of Tulsa, overlooking the Arkansas River. The peak of the mountain (where we were located) is the highest point for miles around, and the trees show much damage due to lightning. Inasmuch as we had been having rainy weather accompanied by electrical storms everybody was prepared to vacate on short notice. W5BRX himself was equipped with a tent, completely ditched to keep out the expected rain, but was happily disappointed by the lack of rain. Several other transmitters were operated from the back of cars, trailers, and on card tables, and one even on the ground, before which the operators sat cross-legged, in the best manner of a Turk or something. (Hi.) The Field Day turned out to be a real party, and everyone went home tired but happy.—*W5BRX-5.*

We obtained such excellent results on 56 Mc. that we stopped trying to get the other rigs to work. The continuous barrage of 56-Mc. signals gave us plenty to do every minute of the day. It was not until the very last hour of the contest that we had difficulty in finding new contacts. Everyone here had a splendid time and all of us are looking forward to the next Field Day when we will apply everything that we learned on this one.—*Skywire Radio Association, W8ABS-2.*

On Friday, June 10th, in the evening, W3BTQ, W3GAU, W3DUK, W3DUK's YF and Jr. op., and W3EGV, arrived at White Crystal Beach, on the Elk River at the head of the Chesapeake Bay. Early Saturday morning we started to set things up; rig, receiver, and antenna. The antenna was 132 feet, end fed, strung between a sassafras tree and a stray telephone pole. The transmitter was a 6L6 crystal, 6A6 amp., running from a Mallory vibrapack; the receiver was an SW-3 running from a small dynamotor. About noon, the rig was working well. At about 11:00 p.m., the antenna came down with a crash. It took us exactly 17 minutes to climb the tree in the dark and get back on the air. About 4:45 p.m. Sunday a real storm, as only experienced on the Chesapeake Bay, came up and we were forced to stop operating. Here's

to bigger and better Field Days; may they continue and prosper.—*W3BTQ-3.*

All operation was conducted in the field approximately one mile southwest of Kohler, Wis. Original plans called for the operation of 5 units, but after plenty of QRM trouble, only 3 were put on the air. The 3 outfits were located in approximately a straight line, with the distance between the two outer stations only about 100 feet. The antennas were equally crowded, all 3 ending on the same tree. The longest of these was a 260 foot center fed, with 130 foot feeders, supported on one end by a 75 foot tree. The other two were 133 foot zepps, supported by trees about 50 feet high. The power supply problem was solved through the generous cooperation of the Kohler Co., which supplied two 100-volt a.c. generators, one of 1500-watt rating, the other an 800-watt unit. The gang agreed that the Field Day was very FB, and is already planning on doing big things next year.—*Sheboygan Radio Amateur's Club, W9YWX-9.*

Featured from start to finish by the nastiest tricks in the weatherman's repertoire, the 1938 Field Day was, indeed, one to test emergency facilities to the limit. Any gear which can be operated out of doors for 26 hours continuously without trouble under the conditions which ours had to face surely rates classification as emergency equipment. The location chosen for this year's struggle was Steerage Rock, 1300 ft. QEL, Brimfield, Mass., and the operating position was the open porch of a small refreshment stand at the top of the mountain. Although we were equipped for 'phone operation on all bands the high noise level caused us to use c.w. exclusively, except on 56 Mc.—*W1HDQ-1.*

W1BB-1 worked on all bands, 1.75 through 56 Mc.!! Location was Orient Heights, Massachusetts, on top of a "Drumlin" 150 feet above sea level, overlooking Boston Harbor. All power was from 6 volt storage batteries and genemotor. Had a wonderful time, lots of good operating, big thrill out of working other Field Day stations, particularly at DX with low power. Fog came in during night so thick could not see antenna pole from car. Biggest thrill was getting message off solid first time to W1EH-1 who was also low power field day battery operated.—*W1BB-1.*

The five transmitters of W8AVH-8 were operating afield near Olmsted Falls, Ohio. This marks the third year of *Westlake Amateur Radio Association's* participation in the field day contest. Of the 76 stations worked, 36 of them were operating portable. Equipment used for power included batteries, gasoline-driven generator, vibrapack.—*W8AVH-8.*

Rig was 6L6G tritet crystal oscillator powered from a vibrator pack, running 300 volts at 50 mils from a storage battery. Receiver was a 6 volt t.r.f. running from a genemotor. Antenna was a 7-Mc. Hertz off center fed, approximately 40 feet high. XU2AA was worked on 7 Mc. All contacts were made from the top of Genesse Mountain, 14 miles west of Denver, at an altitude of approximately 8300 feet.—*W9RRS-9.*

The *Clearwater Radio Club* operated portable at Weeki-wachee Springs, Fla. Ninety-one stations were contacted, twenty of them also on Field Day. All power for lights, fans, transmitters and receivers was obtained from a 1-kw. a.c. generator, gas driven. Fifteen different crystals were used on the 7-, 14- and 28-Mc. bands. The antennas were a 7- and a 14-Mc. doublet, a 28-Mc. Johnson Q, and a rhombic. The rhombic was 330 feet per leg and pointed ten degrees west of north. Quite a time was had putting up the rhombic, weaving it among the trees and all, and getting one end fastened to a tree in the midst of a swamp. We all enjoyed the F.D. very much and are waiting for next year.—*W4EQK-4.*

Our location was provided by W9PRM: A cabin in the woods, several miles from either power or telephone lines, at the foot of Rib Mt. All equipment was operated from batteries, including the lights. The antennas and equipment were installed with the aid of smudge fires and "Flit" guns of mosquito dopell.—*Wassau Radio Operators Club, W9WJD-9.*

The club operated in Palos Hills, near Willow Springs, Illinois. A total of 74 contacts results, 43 being with other portable stations. 18 states were worked. Frequencies of

(Continued on page 82)

Full-Range Selectivity with 455-Kc. Quartz Crystal Filters

A New Filter Circuit with Wide-Range Bandwidth Control

By D. K. Oram*

Here's a new 455-kc. quartz crystal filter which can be adjusted to give any desired degree of selectivity between normal i.f. and crystal maximum—continuously variable, if one likes. Its advantages for 'phone reception are obvious. One-knob control, substantially uniform output over the whole selectivity range.

THE use of quartz crystal filters to increase the selectivity of intermediate frequency amplifiers in communications receivers has become almost universal. Starting with the original article by James J. Lamb,¹ many pages of this magazine have been devoted to technical descriptions of such filters and their operating characteristics, together with such improvements and refinements as have been made

* Chief Engineer, Hammarlund Mfg. Co., Inc., New York City.

¹ Lamb, "Short-Wave Receiver Selectivity to Match Present Conditions," *QST*, August, 1932.

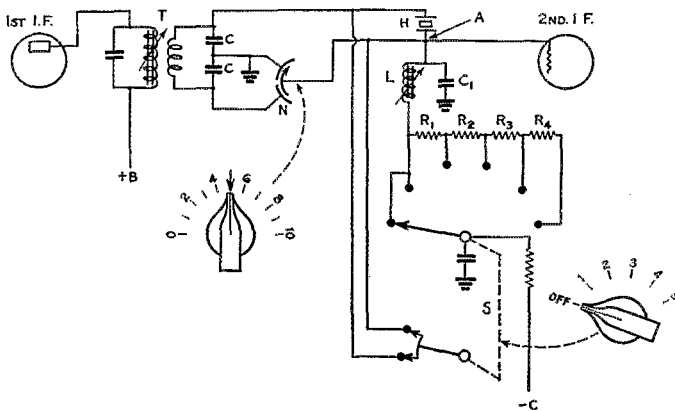
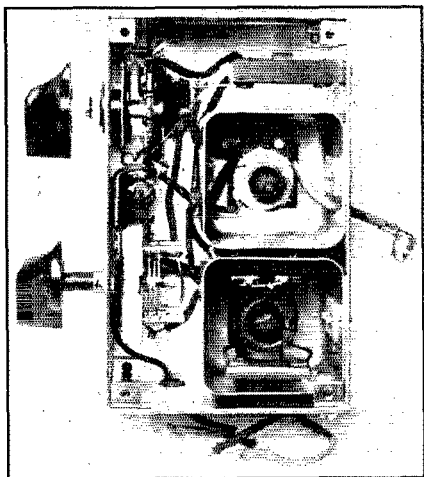

FIG. 1—CIRCUIT DIAGRAM OF THE WIDE-RANGE VARIABLE-SELECTIVITY CRYSTAL FILTER

- T—Permeability-tuned i.f. transformer with low-impedance secondary.
- H—455-kc. crystal and holder.
- C, C₁—Fixed condensers, 100 μ fd. each.
- C₁—85 μ fd. silvered mica.
- N—Phasing condenser, see text.
- L—Iron core i.f. coil, 1.14 millihenrys.
- R₁—25 ohms.
- R₂—50 ohms.
- R₃—300 ohms.
- R₄—2000 ohms.
- S—6-point tap switch, with extra contacts for shorting crystal.



THE COMPLETE WIDE-RANGE VARIABLE-SELECTIVITY CRYSTAL-FILTER UNIT

The switch and resistors are in the upper left corner, with the crystal and holder to the right. The phasing condenser is at the lower left. Transformer T is in the lower right corner, with the output circuit, LC₁, in the can just above. The unit is approximately 2 × 3 × 5 inches.

from time to time. In addition, a complete review of the subject appears in *The Radio Amateur's Handbook*, 1938 Edition. From a perusal of this material one conclusion seems inescapable; crystal filters of to-day are sharp enough, but despite the many improvements made, the variable selectivity feature has not been carried far enough on the broad side to bridge completely the gap between "crystal" and "non-crystal" selectivity at 455 kc., which for obvious reasons is still the most popular frequency for intermediate amplifiers. There is no denying the fact that such a complete range of crystal selectivity would aid materially in voice reception, regardless of receiving conditions.

It is the purpose of this article to describe a

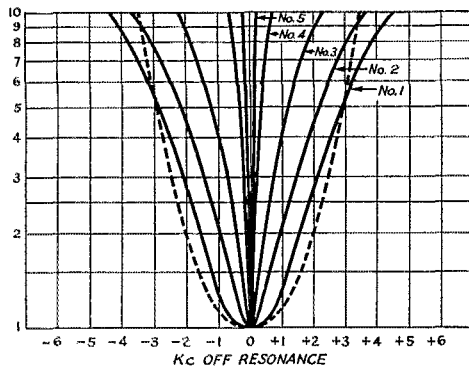

FIG. 2—VARIATION IN CRYSTAL-FILTER SELECTIVITY WITH DIFFERENT VALUES OF RESISTANCE

The dotted curve shows, for reference, the selectivity of the two-stage i.f. amplifier without the filter; solid lines are crystal filter alone.

new 455-kc. quartz crystal filter which does meet this variable selectivity requirement, and in addition affords several other operating advantages. Its circuit diagram is shown in Fig. 1. *T* is a permeability-tuned stepdown transformer having a high-impedance tuned primary to provide efficient loading in the plate circuit of the first i.f. amplifier tube. Its secondary is of relatively low impedance in order to deliver a substantially constant voltage to the quartz crystal and its variable impedance load. The secondary is center-tapped to ground by means of two matched fixed condensers, *C-C*, to provide a neutralizing voltage 180° out of phase with the voltage fed to the crystal. *N* is the neutralizing or phasing condenser, and is of the opposed-stator type. While the capacity of the rotor to each stator of this condenser varies in the normal manner as the rotor is turned, the capacity between rotor and both stators in parallel remains constant regardless of the angular position of the rotor. The importance of this feature will appear later. The crystal holder *H* is made of isolantite. Its unusual design reduces its capacity to a minimum and provides a uniform air-gap between the crystal and its electrodes, which are of stainless steel, surface-ground to insure flatness. The quartz crystal itself is of special cut, having a very high *Q* and complete absence of spurious responses within ± 40 kc. of its 455-kc. natural period.

We now come to the load or crystal output circuit, which constitutes the most interesting feature of this new filter, since it provides the expanded control of selectivity which is admittedly so desirable. It consists of the permeability-tuned coil *L* and its associated fixed condenser *C*₁.

OUTPUT CIRCUIT OPERATION

It will be necessary at this point to depart somewhat from routine description in order to

consider the effect of this load circuit on the selectivity characteristic of the crystal filter unit as a whole. There is no doubt whatever that a higher load impedance results in wider filter response. There are, however, at least two ways of explaining this well-known effect. To date, the most generally accepted idea has been to regard the load impedance as an addition to the effective series resistance of the quartz crystal, thus decreasing its *Q*. In the present discussion, since the voltage feed to the crystal is essentially constant over the narrow band width involved, as previously explained, the crystal and its load circuit in series will be considered as the two sections of a voltage divider. The actual voltage in which we are interested is that existing at the junction of the two sections of this divider, which is directly connected to the grid of the succeeding i.f. amplifier tube (point A in Fig. 1). Since both sections are tuned circuits (although one is the quartz crystal) it is obvious that the impedance of such a voltage divider will vary considerably with frequency. Since the voltage across it remains substantially constant, it necessarily follows that the amplitude of the voltage at point A will depend directly on the relation of the impedances of the two divider sections, which in turn will depend on the impressed frequency. The

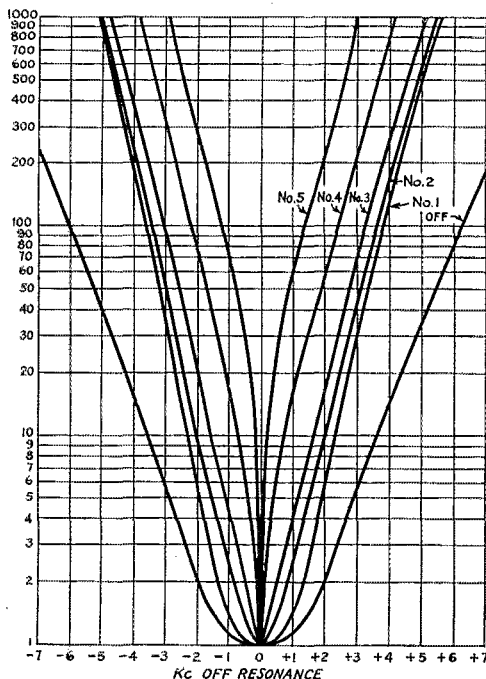

FIG. 3—OVERALL RESONANCE CURVES (CRYSTAL FILTER PLUS I.F. AMPLIFIER) WITH PHASING CONDENSER SET TO NEUTRALIZE THE CRYSTAL-HOLDER CAPACITY

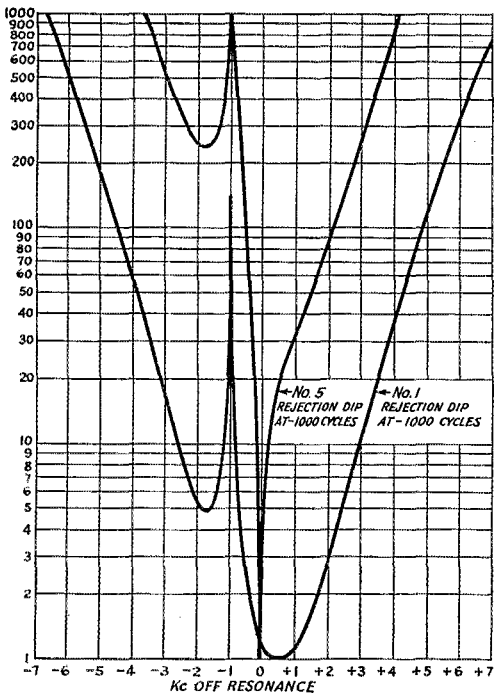

FIG. 4—ILLUSTRATING REJECTION ACTION FOR TWO DIFFERENT DEGREES OF SELECTIVITY

constants of the two sections differ so enormously from each other that small changes in the impressed frequency produce correspondingly great differences in their respective voltage drops, with consequent changes in the potential of point A. To illustrate: if we assume that the phasing condenser N has been adjusted to neutralize exactly the capacity of the crystal holder, the quartz crystal can be considered as a series-tuned circuit having inductive and capacitive reactances, X_L and X_C (equal at resonance) of about 60,000,000 ohms, series resistance R of 4000 ohms and Q of 15,000. Coil L , forming the lower section of the divider, together with its tuning condenser C_1 , becomes a parallel-tuned circuit having reactances of 3200 ohms, R of 24 ohms, and Q of 133. At precise resonance the crystal presents but 4000 ohms resistance, while the parallel tuned circuit presents a resistance of 425,000 ohms ($Q \times X$, or $\frac{\omega^2 L^2}{R}$). Therefore, at the frequency

of crystal resonance, substantially all the voltage supplied to the crystal by transformer T appears at point A and is applied to the grid of the second i.f. amplifier tube.

For frequencies slightly above or below the crystal resonance frequency, the impedance relations of the two sections of the voltage divider change appreciably. Because of the very high value of the reactance components of the quartz

crystal, even a slight departure from its resonant frequency causes a relatively large increase in its net reactance. On the other hand the impedance of the parallel tuned circuit, due to its much lower Q , changes very slowly with slight departures from resonance. To give a clear picture of these impedance changes they are listed below for several degrees of departure from the frequency of exact resonance.

Departure from Resonance *	Impedance	
	Quartz Crystal	Parallel Tuned Circuit
0 cycles	4,000 ohms	425,000 ohms
± 20 "	6,500 + "	425,000 - "
± 50 "	13,600 "	425,000 "
± 100 "	26,400 "	424,000 "
± 500 "	132,000 "	408,000 "
± 1000 "	264,000 "	367,000 "
± 1500 "	395,000 "	320,000 "
± 2000 "	528,000 "	277,000 "
± 3000 "	792,000 "	211,000 "

* While not strictly the same on both sides of resonance, the differences are too slight to affect this discussion. For very great departures from resonance, the differences are significant.

As the impressed frequency departs from the crystal resonance frequency its series impedance rises steeply and, due to the extremely high Q , is almost entirely reactive, even for the small departure of 100 cycles. On the other hand, the impedance of the parallel tuned circuit falls but slowly and the resistive component remains large even for departures as great as 3000 cycles. Therefore, it will introduce no great error to assume 528,000 ohms as the reactance of the crystal, and 277,000 ohms as the resistance of the load circuit at ± 2000 cycles from resonance. Since the total impedance of a reactance and a resistance in series is given by $\sqrt{X^2 + R^2}$, the total impedance of the voltage divider at 2000 cycles off resonance

amounts to 596,000 ohms, and $\frac{277,000}{596,000}$ or 46.5 per cent of the total voltage impressed on the crystal will appear at point A. This corresponds to an attenuation of slightly more than 2, or a little more than 6 db. Under these conditions the

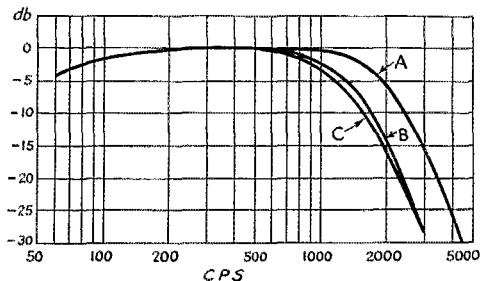

FIG. 5—AUDIO RESPONSE CURVES

A, with switch in "off" position; B, with switch in No. 1 position (broad), and phasing condenser at neutralization; C, same as B but with phasing condenser set for rejection at 1000 cycles below resonance.

selectivity curve of the filter will be strictly symmetrical, and the band width at an input ratio of 2 will be almost exactly 4 kc. This degree of selectivity is of the same order as that provided by a two-stage tuned i.f. amplifier designed for communications work. Consequently, if filter and amplifier are cascaded, the band width will be approximately 3 kc. at the same input ratio of 2. This degree of selectivity is just about ideal for the first step from "crystal out" to "crystal in." So much for the broad extreme of crystal selectivity.

PRACTICAL METHODS

From the above, it is apparent that the range of selectivity obtainable from a crystal filter unit is limited by but two factors. Maximum, or sharp, selectivity is limited only by the *Q* of the quartz crystal itself. Minimum, or broad, selectivity is limited only by the magnitude of the *average* load impedance into which the crystal works.

(Continued on page 58)

The Philco "Mystery Control"

SPECULATION has been rife in amateur circles concerning the "innards" of the much-publicized Philco remote-control unit. Guesses seem about equally divided between some sort of spark-coil scheme and an ultra-high-frequency system. Both are wrong. The remote-control box uses an oscillator, true enough, and the pick-up arrangement bears close resemblance to an ordinary receiver. The contention, however, is that the system is not worked by radiation from the oscillator but by *induction* between a coil in the control box and a similar coil in the receiver.

The distinction calls for a little explanation. Two types of fields are set up about any circuit carrying an oscillating current. The radiation field, the one which concerns us in radio transmission, travels outward from the source with the velocity of light and, with uniform conditions, its strength is inversely proportional to the distance. The strength of the induction field, however, is inversely proportional to the *cube* of the distance, and for that reason is of negligible consequence at any distance from the source. It is, however, the predominant field very close to the source. We use induction for coupling between circuits in our transmitters and receivers, but radiation for communication over distances.

The limit of the induction field may be taken to be the distance at which its strength and that of the radiation field are the same. This distance is equal to the wavelength divided by 6.28 or, more conveniently, the distance in feet is equal to 157,000 divided by the frequency in kilocycles. At distances which are small compared to the answer given by this formula, the effect produced in a receiving device may be considered to be wholly

the result of induction rather than radiation. Obviously, too, for remote-control devices designed to work over reasonable distances, the frequency chosen must be low, since the quotient will be larger as the denominator is made smaller. In the Philco unit the maximum distance considered is 75 feet, and the frequencies used are in the vicinity of 375 kc. Amateur-band frequencies, even 1750 kc., are out of this picture because they greatly restrict the range.

There is, of course, radiation from the oscillator even though it is not used in the control system. It is small, however, for two reasons; the power in the control oscillator is very low, and the primary coil is very small compared to the wavelength so that it is an extremely inefficient radiator. Even within the induction field the oscillator should cause little interference with regular reception on the same frequency, because the electrostatic component of the field is horizontally polarized (the plane of the coils is horizontal), whereas radio waves at these frequencies are vertically polarized. Since the control unit is battery-powered, there is no possibility of leakage "through the back door" to permit possibly serious radiation from power lines.

The practical unit uses a Type 30 tube as an oscillator, with a 3-volt "A" and 45-volt "B" battery in the portable container. A telephedial type "pulser" permits a choice of any of eight stations to which the receiver proper is pre-tuned. The "A" battery is connected to the tube only when the dial is being operated. Volume also can be controlled from the dial. In the receiver, there is a four-tube control amplifier with a new thyatron tube (2A4G) in the output stage; a relay in its plate circuit controls the "stepper" switch which selects the desired station. The volume control is motor-driven, the motor also being controlled by the relay. The stepper assembly is a latching arrangement with a ratchet which moves one step for each pulse from the control unit. Details of the Philco installation are given in the current issue of "Radio Today" and in October "Communications." Since they are rather specialized they are not reproduced here. The general principles as outlined above can be applied readily to amateur remote-control work, however, particularly since the 2A4G thyratrons will be available in the very near future.

If there is no radiation from this type of control unit it is not radio equipment and does not come under the Communications Act. Some radiation is inevitable, however, and pending a settlement of the legal questions, the F.C.C. tentatively has set up the requirement that the field from such devices shall not exceed 3 microvolts per meter at the distance 157,000/f(kc.). This does not imply that the radiation field from such a device, even though within the specified limit, can be used without a license.

—G. G.

How Much Condenser Spacing?

Circuits to Lower Voltage Across Condenser Plates

By T. M. Ferrill, Jr.,* W1LJI

TWO disadvantages result from increase of plate spacing in tuning condensers; increased cost and increased size. In order to retain a required amount of capacity in a condenser of fixed plate size when spacing is doubled, the number of plates must be doubled and the length of the rotor assembly must be almost quadrupled. Furthermore, the peak voltage rating of variable air condensers is less than doubled by doubled plate spacing. From these facts may be seen the desirability of keeping the peak voltage across tuning condensers and tuning condenser sections at the lowest value for proper operation.

In the case of a type of plate tank circuit in very common use with push-pull r.f. stages and neutralized single-tube stages—that using a split-stator tuning condenser as shown in Fig. 1-A—the maximum voltage peak across a section of the condenser results from addition of the plate supply voltage (d.c. or d.c. with modulation) to the peak r.f. voltage existing across the condenser section. This is shown in A of Fig. 2 for the condition existing with telegraphy, and in B of Fig. 2 for the condition existing with plate modulation. These diagrams give the actual d.c., r.f., and a.f. voltages across a single section of a properly adjusted tuning condenser in a push-pull r.f. amplifier, with 1250-volt plate supply and 200-ma. plate current.

ing condenser rotor is carefully insulated from all grounded objects and circuits, and is placed substantially at ground r.f. potential by means of a high-voltage blocking condenser. The capacity of this blocking condenser is usually of the order of 0.001 or 0.002 μ fd. In case of a too-high voltage peak across the condenser section causing a momentary breakdown, this condenser prevents a complete path for the supply voltage directly through the arc between condenser plates, and thus limits the potential for this arc approximately to the r.f. voltage existing between the plates. In a circuit without this blocking condenser, once the high peak voltage has broken down the path between condenser plates, supplying initial cause for an arc, the voltage required to maintain the arc is only a fraction of that required to start it, and the supply voltage maintains a hot and continuous arc in the tuning condenser section, damaging the condenser and overloading the power supply and other equipment until the power is removed.

One badly erroneous general impression seems to exist regarding the function of the blocking condenser as ordinarily used—the impression that it completely removes the supply voltage from the tuning condenser. Contrary to this general impression, nearly all the supply voltage continues

If your plate tank condenser flashes over you should read this article. The cold dope on circuit arrangements to minimize potential across tank condenser plates—and how to figure the plate spacing you need for any amplifier, c.w. or 'phone.

REMOVAL OF SUPPLY VOLTAGE

In order to "remove the plate supply voltage from the sections of the split-stator tuning condenser," the circuit of Fig. 1-B has been used commonly. In this arrangement, the tun-

*Technical Department, QST.

FIG. 1—SPLIT-STATOR CONDENSER TANK CIRCUITS

All three are equivalent from the standpoint of r.f. voltage and current. They are markedly different with respect to d.c., however, as the d.c. equivalent circuits given below clearly show.

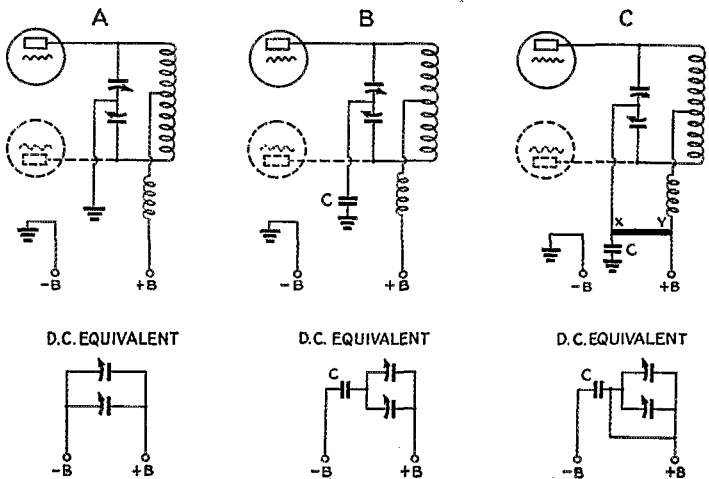

WITH TUNING CONDENSER CONNECTED AS IN A OR B OF FIG. 1

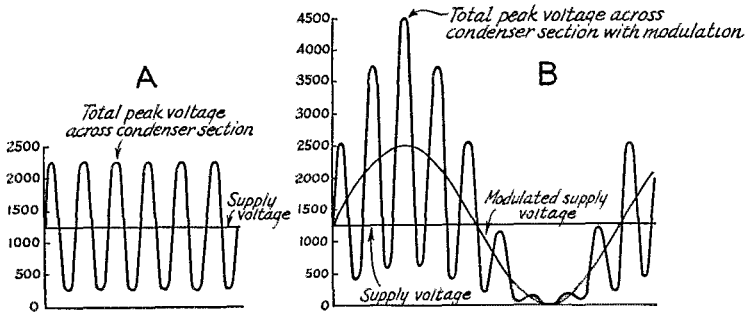

WITH TUNING CONDENSER CONNECTED AS IN C OF FIG. 1

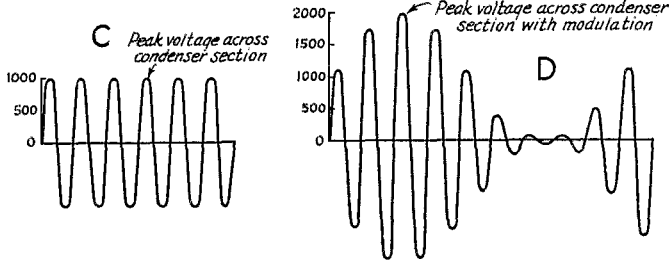

to exist across each section of the tuning condenser and thus to contribute to high voltage peaks after the insertion of the blocking condenser between the "ground" wiring and the condenser rotor. The explanation of this fact is shown in the d.c. equivalent circuits beneath A, B and C in Fig. 1. As can be seen here, the sections of the tuning condenser are effectively in parallel, and in Fig. 1-B the parallel combination of these capacitances is in series with the blocking condenser across the supply voltage (d.c. or modulated d.c.). Since the usual capacity of the blocking condenser is in the neighborhood of 0.002 $\mu\text{fd.}$ and the total capacity of the effectively parallel condenser sections is usually 200 $\mu\text{fd.}$ or smaller, the blocking condenser and the tuning condenser act as a voltage divider with nearly all — usually more than 90 per cent — of the supply voltage across the parallel sections (and thus across each section) of the tuning condenser, since the voltage across capacitances in series is inversely proportional to the capacities.

A simple remedy for this condition is shown in Fig. 1-C. Here, a connection is made from the positive supply voltage terminal of the amplifier to the rotor of the condenser. For d.c. and audio frequency currents, the effect of this is a connection from the rotor to the stators of the tuning condenser sections, a connection which definitely removes all except r.f. voltage from the tuning condenser.

Three split-condenser amplifier plate circuits with supply voltage removed by this method are

shown in Fig. 3. In the first two, the condenser rotor connection is added as described above. In the third — the circuit of a parallel-fed single tube amplifier — the plate coil is provided with a d.c. ground by connection of an r.f. choke between the center-tap of the coil and the negative high-voltage supply terminal.

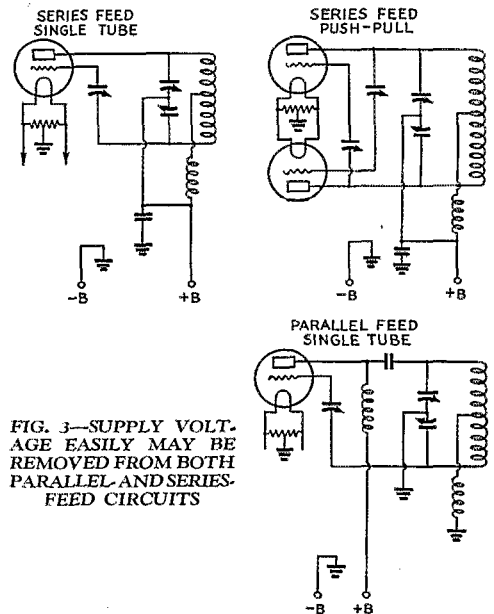

FIG. 3—SUPPLY VOLTAGE EASILY MAY BE REMOVED FROM BOTH PARALLEL AND SERIES-FEED CIRCUITS

FIG. 2—VOLTAGES APPEARING ACROSS A CONDENSER SECTION OFF FIG. 1-B AND FIG. 1-C

Note that the peak voltage per section of the condenser in Fig. 1-B (and also that of Fig. 1-A) is more than double that of Fig. 1-C. Thus, the connection of Fig. 1-C saves materially in size and cost of the tuning condenser.

It is extremely important in the circuits having positive high voltage applied to the condenser rotors (as well as in those in present use with blocking condenser separation of rotor from ground) that thorough and dependable insulation be used between the condenser rotor shaft and the tuning control. A serious hazard would otherwise exist.

FIG. 5—OTHER CIRCUITS IN WHICH ONLY THE R.F. VOLTAGE IS APPLIED TO THE TUNING CONDENSER

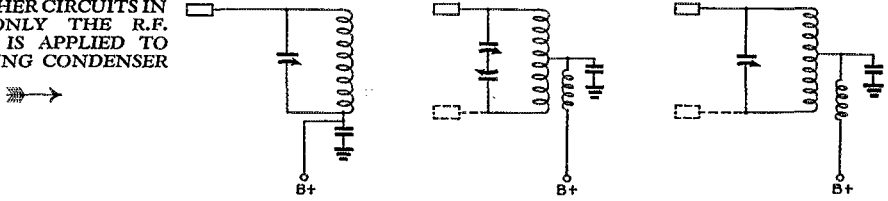
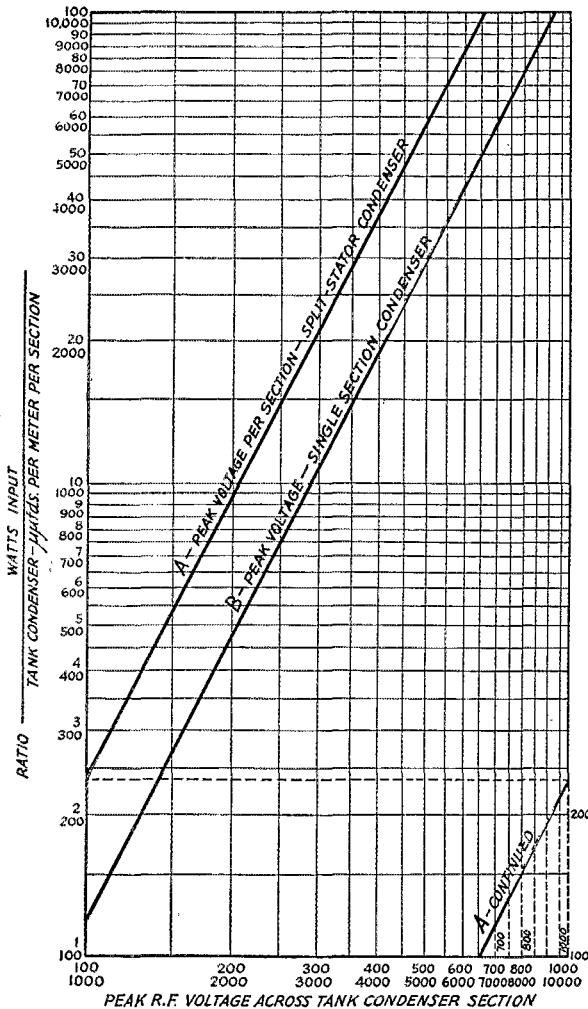
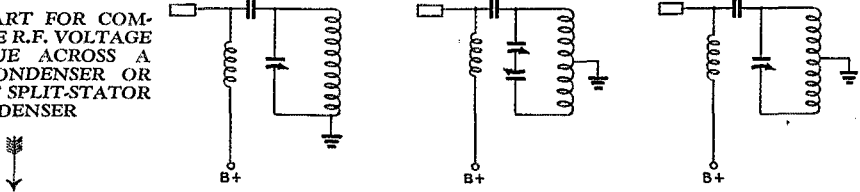

FIG. 4—CHART FOR COMPUTING THE R.F. VOLTAGE PEAK VALUE ACROSS A TUNING CONDENSER OR SECTION OF SPLIT-STATOR CONDENSER



DETERMINING CONDENSER PEAK VOLTAGE

A chart for computing the r.f. peak voltage per section across single-section and split-stator condensers is given in Fig. 4.¹ This chart applies to the circuits of Fig. 5 as well as to those of Fig. 3. If the circuit used in an amplifier corresponds to A or B of Fig. 1, the maximum value of supply voltage must be added to the r.f. voltage obtained from Fig. 4 to give the total peak voltage across a condenser section.

An interesting condition may be noticed in an amplifier using the tank circuit of Fig. 1-B, with keying. If the tank condenser spacing is computed without allowance for the supply voltage, the first contact of the key results in a flashover (and continued arc until the key contact is broken or the power is removed) of the tuning condenser. If the key is immediately opened when the arc occurs, and then pressed a second time, the arc is less likely to occur. After a few dots sent with the key, it is likely that no more condenser arcing occurs for an extended period. The explanation of this behavior is the fact that when an arc occurs in the tuning condenser, the d.c. voltage between the plates becomes smaller, and the voltage across the blocking condenser thus increases. As the charge of the blocking condenser approaches the supply voltage, the d.c. voltage across the tuning condenser sections

(Continued on page 78)

¹ Prepared by WITS for the 1939 Handbook from data furnished by Allen D. Cardwell Mfg. Co.

How Would You Do It?

Methods of Making Connections Between Transmitter Units

PROBLEM No. 21, announced in *QST* for September, is one of those which appear simple on the surface but which offer plenty of brain exercise when one gets down to practical application. One contestant suggested that Our Hero's problem was no problem at all, yet the solution submitted had limited application and offered little in the way of safety precaution. A few realized that a problem did exist and put their minds to work with gratifying results.

Those who submitted solutions were practically unanimous in the opinion that wires between units should be formed into a cable of some sort. Multi-conductor cable of the type used often in receiver service is satisfactory in low-power transmitters. Where voltages exceed five or six hundred, however, the positive high-voltage lead should have better insulation than that provided by the receiver cable. Automobile ignition cable is quite satisfactory for the purpose since it is insulated for several thousand volts. The receiver type cable is also unsatisfactory for filament circuits carrying heavy current. Sometimes conductors in the cable may be paralleled to take care of moderately heavy currents. In general, it is usually preferable to make up a cable with the requirements of the job in mind.

No. 14 to No. 10 wire with a small amount of rubber insulation may be used for filament circuits. A good grade of push-back wire may be used for all other wiring carrying less than 500 or 600 volts and wire such as the automobile ignition cable mentioned previously may be used for the higher voltages.

Manufactured multi-conductor cable is not so practical as cable made up for the job in many instances. It is common practice to place all meters in one rack unit and often it is necessary to make connections between one power-supply unit and two or more r.f. units. In cases such as these, the ready-made cable is rather difficult to adapt.

Various types of cable terminations which permit easy connection and disconnection of most transmitter units were suggested. One of the popular types of termination is the sort of plug which fits into a standard tube socket mounted on each transmitter unit. These plugs are obtainable with standard pin arrangements to fit any tube socket from the four-prong variety up to the eight-prong octal type. Discarded tube bases may be used for the same purpose. Insulation is

sufficient for at least 500 or 600 volts. Pins may be connected in parallel for heavy filament currents. If the transmitter unit is mounted on a standard metal chassis, the socket may be sub-mounted at the rear or at one end. Since the plug is removed first, it does not interfere with removal of the unit from a rack of standard dimensions. With breadboard arrangements, the socket may be mounted on spacers and fastened to the baseboard with wood screws. This makes a neat and shock-proof arrangement for low- or medium-power transmitters.

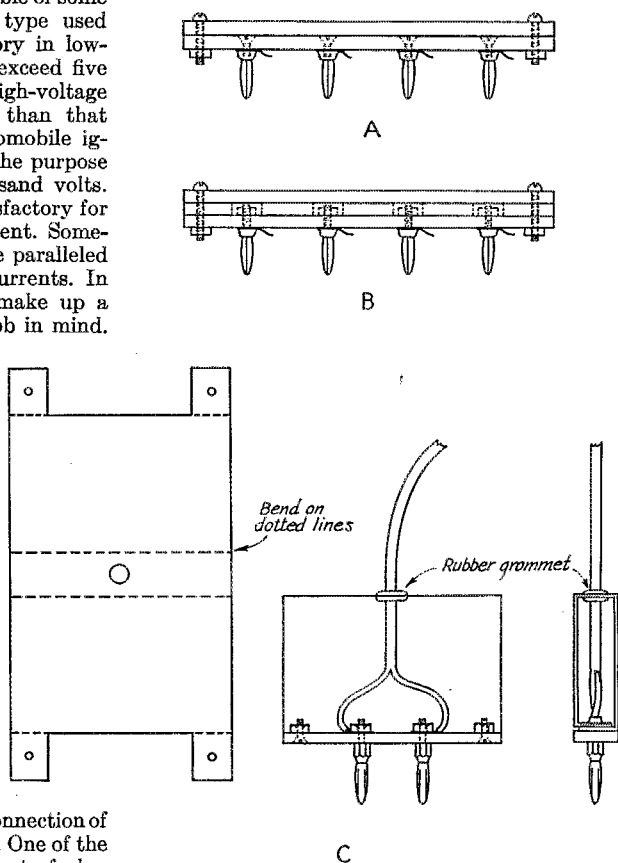

FIG. 1—METHODS OF ELIMINATING EXPOSED POINTS ON PLUG CONNECTING STRIPS

At A, flathead screws are countersunk and the heads covered with an extra strip of insulation. At B, clearance holes are drilled in central strip and a third strip used to cover the exposed nuts when using the threaded type plugs. At C, a metal shield is provided to cover exposed units.

Problem No. 23

We think our Hero has a sticker this time. The contest season is coming on now and at least four of the more important ones offer bonuses for operators who limit the power input to the final amplifier to some specified value. Our Hero wants to take advantage of the extra multiplier for low-power c.w. operation and yet previous experience has shown that, when the going gets hot, the continual check upon the power input and careful adjustment of coupling necessary to keep the input near the handicap limit hampers him considerably. He wonders if there is something which he could apply to his transmitter which could be adjusted to permit input of some fixed value to the final amplifier and automatically maintain it at that value within reasonably close limits regardless of variation in excitation or degree of antenna coupling.

Another type of termination which is more suitable for higher voltages consists of a strip of insulating material such as bakelite or masonite fitted with a series of phone tips or banana-type plugs which fit into a corresponding series of jacks mounted on the transmitter unit. Methods of construction which leave no exposed connections are shown in Fig. 1. The method shown at A requires the tapped type of plug produced by Johnson. The flat-head screws are countersunk in the lower strip and the top strip, which forms an insulating cover, is fastened by means of the screws at the ends. If desired, screw-rungs, obtainable at most hardware stores, may replace the end screws to form pulls for removing the strip. An alternative would be to shape a handle from strip metal and fasten it to the strip by means of the end screws. The insulating strips should be at least one inch wide so that the soldering lugs to which the cable wires are connected are not exposed at any point.

The more common threaded type plugs may require a third strip as shown at B. Clearance holes for the nuts and top parts of the plugs are drilled in the central strip. If a 6-32 tap is available, the central strip may be eliminated by tapping holes in the lower strip and filing the projections of the plugs above the strip flush with the surface.

A third form of protection, suggested by

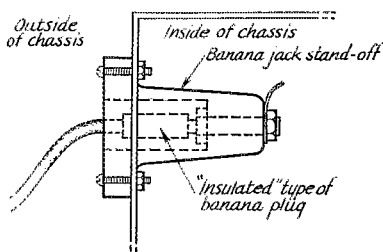

FIG. 2—NOVEL METHOD OF MOUNTING JACK-TOP INSULATOR TO AVOID EXPOSING "LIVE" PARTS

W6JTF, is shown at C. Here a metal shield is cut out from sheet stock and bent in the shape shown and fastened to the plug strip. A rubber grommet at the top prevents the cable from wearing.

Phone tips are less expensive than banana plugs and will serve quite well under most circumstances. The usual tip is of the right inside diameter to be tapped with a 6-32 thread so that it may be fastened to a strip by means of a machine screw in a manner similar to that shown at A. If a tap is not available, a 6-32 machine screw may be filed down to fit the tip and the tip soldered to the screw.

While they are somewhat more expensive, phone tips and banana plugs are obtainable with insulated grips and color coding. They provide greater flexibility than the strip-type mounting, since each wire may be changed at will. This arrangement is particularly handy for experimental hook-ups and works well in permanent wiring. A meter panel, in which each meter is provided with a pair of jacks, renders the meters immediately available for temporary use in external circuits.

Jacks for either tips or banana plugs may be mounted on each transmitter unit. If the transmitter is built up on standard chassis units, the jacks may be mounted on a strip of bakelite or similar material and the strip mounted in a cut-out at the rear or one end of the chassis, or a round clearance hole for each jack may be drilled in the chassis. If mounted at the end, it will be necessary to space the strip back from the surface of the chassis end so that the outside edges of the jacks will come flush with the end of the chassis. It is a good idea to do this anyway, to eliminate all exposed contacts. Both tip-jacks and jacks for banana plugs may be obtained with insulated tops and in a variety of code colors.

For exceptionally heavy currents, the "jumbo" type banana plugs may be required. For very high voltages, W6JTF suggests the unusual insulator arrangement shown in Fig. 2. A clearance hole is cut in the rear edge of the chassis to allow a stand-off insulator to be mounted backwards as shown. The jack in the top of the insulator is reversed so that the plug may be inserted from the outside. This arrangement completely eliminates any exposed "live" metal parts.

Standard 110-volt plugs and receptacles are favored for transformer primary connections and control wiring although it is quite possible that the tube-base plug and cable would fit into this service in some installations; 110-volt plugs and receptacles were also suggested by some for interconnecting units of the transmitter.

W8QED is responsible for the novel idea shown in Fig. 3. A horizontal row of plugs is mounted at the rear of the transmitter at the level of each transmitter unit. Vertical bus-bar wiring connects in parallel each plug at one level with corresponding plugs at the other levels. The

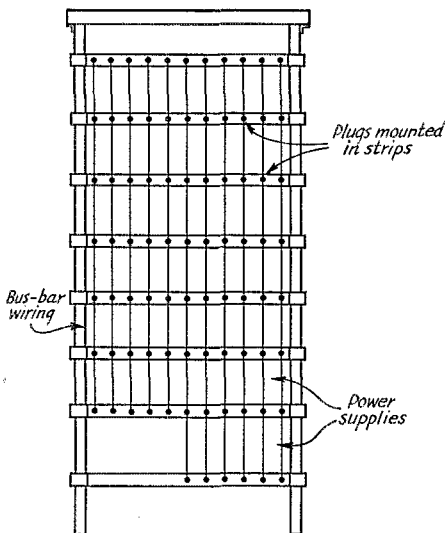

REAR VIEW OF
TRANSMITTER FRAME

FIG. 3—IN THIS ARRANGEMENT AT REAR OF TRANSMITTER FRAME, CONNECTIONS TO PROPER CIRCUITS ARE MADE AUTOMATICALLY WHEN TRANSMITTER UNIT IS PUSHED INTO PLACE FROM FRONT

transmitter units are built to slide into the frame from the front on tracks fastened to the side of the frame. The rear edge of each unit is provided with jacks which make connections with appropriate plugs when the units are pushed into place. The jack arrangement at the rear of any particular transmitter unit will depend upon to which of the bus-bar circuits connections are desired. Voltages may be changed by altering the jack arrangement on the transmitter unit. Jacks are provided only at points at which connections are desired; at other points they are simply omitted. With this arrangement all voltages or external circuits are made available at each level.

Prize Winners

First Prize—Richard Ament, W6JTF

Second Prize—Earl V. Carlson, W8QED

We wish, also, to thank the following for their contributions: W1BLR, W1KKS, W1KWH, W2HFB, W2LXQ, W2KOO, W3HHS, W4DFR, W5FWA, W8OMM, W8PUF, W9VQN, W9YZG, G6TG, VE3SA, VE5UI, C. E. Schlosser.

Rules for the Problem Contest are repeated below:

1. Solutions must be mailed to reach West Hartford before the 20th of the publication month of the issue in which the problem has appeared. (For instance, solutions of problem given in the April issue must arrive at *QST* before April 20th.) They must be addressed to Problem

Contest Editor, *QST*, West Hartford, Conn.

2. Manuscripts must not be longer than 1000 words, written in ink or typewritten, with double spacing, on one side of the sheet. Diagrams and sketches may be in pencil, but must be neat and legible.

3. All solutions submitted become the property of *QST*, available for publication in the magazine.

4. The editors of *QST* will serve as judges. Their decision will be final.

Prizes of \$5 worth of A.R.R.L. station supplies or publications will be given to the author of the solution considered best each month, \$2.50 worth of supplies to the author of the solution adjudged second best. The winners have the privilege, of course, of stating the supplies preferred.

—D. H. M.

Strays

Code practice phonograph records are available from the Ralston Record Company, 5433 Wil-lows Ave., Philadelphia, Pa.

Our Cover

(Continued from page 10)

Our amateur photogs were getting frantic as preliminary developings disclosed that the night of darkness was not going to be long enough for the necessary exposure. Seems as if maybe our tank circuits are pretty efficient these days. The

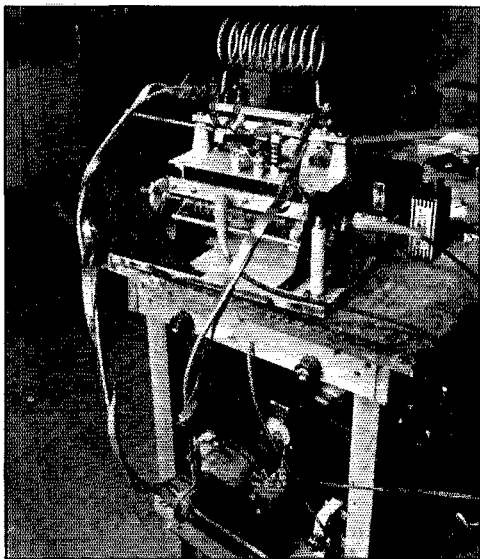

amateur wireless men joined forces and suggested the "booster" shown above to cut down on the exposure time. That's how it was really done.

The wireless men certainly produced more heat, but it's questionable about the increase in output!

• I. A. R. U. NEWS •

Devoted to the interests and activities of the

INTERNATIONAL AMATEUR RADIO UNION

Headquarters Society: THE AMERICAN RADIO RELAY LEAGUE, West Hartford, Conn.

MEMBER SOCIETIES

American Radio Relay League
Asociatia Amatorilor Romani de Unde
Scurte
Associazione Radiotecnica Italiana
Canadian Section A.R.R.L.
Ceskoslovenski Amatéri Vysilaci
Deutscher Amateur Sende-und-Empfangs
Dienst
Eesti Raadio Amatoriide Ühing
Experimental Radio Society of Egypt
Experimenterende Danske Radioamatorer
Federation des Emetteurs Belges
Irish Radio Transmitters Society

日本アマチュア無線聯盟 Japan
Liga Colombiana de Radio Aficionados
Liga Mexicana de Radio Experimentadores
Magyar Rövidhullámú Amatőrök Országos
Egyesülete
Nederlandsche Vereeniging voor Interna-
tionaal Radioamateurisme
Nederlandsch-Indische Vereeniging Voor
Internationaal Radioamateurisme
Newfoundland Amateur Radio Association
New Zealand Association of Radio Trans-
mitters
Norsk Radio Relæ Liga

Polski Związek Krotkofalowcow
Radio Club de Cuba
Radio Club Venezolano
Radio Society of Great Britain
Rede dos Emissores Portugueses
Reseau des Emetteurs Français
Reseau Luxembourgeois des Ama-
teurs d'Ondes Courtes
South African Radio Relay League
Suomen Radioamatööriliitto r.y.
Sveriges Sandareamatorer
Union de Radioemisores Españoles
Union Schweiz Kurzwellen Amateure
Wireless Institute of Australia

Conducted by Byron Goodman

United States

(For quite some time we have been presenting in this column news and impressions of countries outside of W, as being of interest to W hams. We were fortunate to have Mr. John Shirley, ZL2JQ, here as a visitor for a short while, and were able to prevail upon him to set down, as a visiting ZL, his impressions of amateur radio in this country.)

AMATEUR radio in the U. S. differs considerably from that in New Zealand, and I am sure that other amateurs who have been privileged as I have to make a study of radio equipment and of technique here have been just as amazed and interested.

To my mind the comparative cheapness and accessibility of equipment in the U. S. is responsible for the most outstanding difference between stations in this country and elsewhere—the extremely high power in general use. I found that full “kilowatt” stations are common. Although these stations are generally models of efficiency and sometimes superior to commercial set-ups, it is my opinion that the ease in obtaining suitable equipment at reasonable prices, while responsible for the fact that W signals are generally the loudest on a DX band anywhere in the world, sometimes contributes to a decline in the technical knowledge of amateurs here. If the amateur in N. Z. is dissatisfied with the performance of his station, he will generally read all the available textbooks and endeavor to find some way to improve his present outfit by a more extensive knowledge of the problem, for bigger tubes or new parts may be too expensive or even impossible to obtain. In America there is the other extreme. Amateurs often purchase a complete

commercially built station and, while this results in a fine signal on the air, the operator may never know any more technically than was required for his examination.

However, most American stations are far superior to those in N. Z. This is particularly the case with receivers. Many N. Z. DX men are still using 2- and 3-tube regenerative receivers, while it is exceptional to find a station here not equipped with a fine communications-type superhet with crystal filter.

To force a signal through other competitive W signals and enable reception in the poorer receivers at the DX end, hams here have gone in extensively for such things as beam antennas, e.c. oscillators, and more and more power. Altogether one gains the impression that if the DX stations use still lower power, the American amateurs invest more dollars in their receiving equipment; and on the other hand, if the DX has difficulty in reception from U. S., he does not improve his receiver but rather waits for the American to improve his signal strength. This may seem quite unsporting on the part of the DX man, but is not necessarily so, for in N. Z., for example, equipment costs four times its price in the United States and, generally speaking, the amateur in N. Z. invests just as much in his equipment as his brother ham here. The resulting set-up is disappointing to the New Zealander when he reads *QST* and sees with envy the rigs in use here. He compares his set, probably full of makeshift gear, and, as he has already expended all the capital he can, he must, after improving his efficiency and operating to a maximum, be content to sit back and exploit the fact that he is in a DX country.

(Continued on page 88)



OPERATING NEWS



Conducted by the Communications Department

F. E. Handy, Communications Manager

E. L. Battey, Asst. Communications Manager

Coming Activities. Don't miss the following operating events:

The A.R.R.L. Copying Bee, Friday, December 9th. See announcement elsewhere in this issue.

A.R.R.L.-Member QSO Party, week-end, January 7th-8th. The member in each Section who chats with most other A.R.R.L. members in the allotted time will receive a memento.

A.R.R.L.'s Eleventh International DX Competition: Radiotelegraph Contest, March 4th-12th; Radiotelephone Section, March 18th-26th.

Use QMH-QHM-QML-QLM Plan of Operating. From a communications standpoint the crowding of scores of stations into a limited sector of any of the several bands of varying numbers of kilocycles is an unnecessary and unintelligent business. This is to call upon all amateurs, particularly those outside the U. S. A., to specify their method of tuning frequently to make all operating more pleasant and effective for everybody. To quote from a letter just received will make our point clear:

"During A.R.R.L.'s recent DX contests, QST advocated the intelligent use of QML-LM-MH-HM * signals by the stations concerned. I have frequently made use of this excellent way of indicating how the receiver will be tuned after a CQ. To my astonishment many W stations have asked me the meaning of these new signals!

"From Oct. 1st to 17th I worked 275 W stations, all operating between 14,390 and 14,400 kc., approximately 27.5 stations per kilocycle! Many operators seem under the wrong impression that unless they are right near the edge they miss a lot of DX work. *This is completely fallacious.* Even on the most selective communications receiver it is hard to get even 10 per cent of the talk when a station is on the extreme high end of the band. QRM makes reception impossible for all but the highest powered! Many U. S. A. stations are fortunate possessors of a selection of crystals, so they can operate intelligently. Why not use them?

"It is to the interest of W stations wanting DX cards or new countries to spread their operation over their available territory evenly instead of crowding the band edge like sheep! I have called a non-existent W station 'TO USE UR OTR FQY OF 14,320 KCS.' Then on that frequency, lo and behold, I often have found one or two stations parked there giving me a short call. From this I assume many DO have plenty of crystals or well calibrated master oscillators. This

* From "Operating an Amateur Radio Station" which covers standard amateur practices:

QHM—Will start to listen at high frequency end of band and tune towards middle of band.

QME—Will start to listen in the middle of the band and tune toward the high freq. end.

QLM—Will start to listen at the low frequency end of band and tune towards middle of band.

QML—Will start to listen in the middle of the band and tune toward the low frequency end.

It is unnecessary and undesirable to crowd our stations into the few kc. at the band edges. Use "MH" and "ML" tuning, and take your pick of the flock of answers you get! More QSO's, less wasted time, shorter calls, and less QRM are all among the advantages.

is a plea to U. S. stations on the 14-Mc. band to get off the high edge of the band. Also to bring into popular daily use the whole 'QHM' series of signals to indicate how the receiver will be tuned."

—Smüh, CP1AA

The above speaks for itself. The writer observes in his letter that there *should* be more occupancy between 14,235 and 14,380 kc. in this band, and we observe that improvement ought to be effected similarly in other amateur bands. "SS" and ORS contest operating make other cases in point just as important as the excellent example. The remedy is to use *all* our frequencies, to use and insist that others use the convenient tuning indicators suggested. We again earnestly recommend them to your attention for use by all amateur operators—to make results for each one of us better, good QSOs easier.

—F. E. H.

Briefs

For code practice at the higher speeds W1HRE offers transmissions at 4:00 P.M. EST, each Friday, 3585 kc., 15 to 50 w.p.m.

Don't make application for membership in the Powerful Peanut Whistle Breakfast Club if you use more than 20 watts input. This club, meeting on 3.9-Mc. 'phone each morning, except Sunday, at 7:00 A.M. EST, has as members W8SEW, W4EYN, W3CZX, W3EOX and W3EMX. Incidentally, W8SEW, Clarksburg, W. Va., has worked 43 states on 3.9-'phone with 17.8 watts input!

Of the single-operator stations listed in the B.P.L., November QST, the first three stations, four of the first five, and five-ninths of the entire list are active members of the Hit & Bounce Net, which uses 14 and 7 Mc. for fast work across the continent and to insular possessions, and 3.5 Mc. for local deliveries to State Nets. The H. & B. BPL-ers are W4PL, W6IOX, W3EML, W3CIZ, K6NXD and K5AA.

W6OFD took some time out to examine W6MVK's log of the 1937 Sweepstakes Contest and he brings to light what is probably a record for "Working All States." During the '37 SS, W6MVK contacted *all states*, plus Alaska, Hawaii, P. I., and all Canadian districts, in 29 operating hours! 11 hours and 40 minutes of operation found all states worked with the exception of Nebraska, Georgia and Louisiana. Also during the '37 SS, W9LEZ claims a "worked all W districts" record; on November 21st, between 1:42 and 2:36 A.M., he worked on CQ's, in order, W3NF, W5FZD, W9FFU, W7EUY, W4DAR, W2HJK, W1APA, W6HZZ and W8QXS . . . but the real satisfaction for W9LEZ came from the fact that he wasn't making any attempt to work all districts in record time.

W3EEW makes the observation that it is quite possible to Work All States without a W2 QSO!

PRIZES FOR BEST ARTICLE

The article by Mr. John Allan Bryant, W4DGC* wins the C.D. article contest prize this month. Each month we print the most interesting and valuable article received marked "for the C.D. contest." Contributions may be on any phase of amateur operating or communication activity (DX, phone, traffic, rag-chewing, clubs, fraternalism, etc.) which adds constructively to amateur organization work. Prize winners may select a 1938 bound *Handbook*, *QST*, Binder and League Emblem, six logs, eight pads radiogram blanks, DX Map and three pads or any other combination of A.R.R.L. supplies of equivalent value. Try your luck. Send your contribution to-day!

R̄ for Sick C.W. Operating

By John Allan Bryant, W4DGC*

IT SEEMS that something has happened to the quality of c.w. operating in Amateur Radio. A listen to the c.w. frequencies will soon prove that the above statement is true. Too true.

About 2:00 A.M. one morning while listening on 7 Mc. in hopes of a little DX or a good rag chew I heard a fairly weak signal. The sending was rather slow, about 10 or 12 w.p.m., and wasn't exactly like tape sending; in fact, quite a few times the code slurred the dots and dashes of that old stand-by, CQ. (You know, that flexible two-letter-group that is often hashed into such groups as NNGT, KEMA, TRQ, etc.) After vainly listening for his call letters about 30 seconds I decided to do a little research work and see just how many times he would send CQ without signing. He actually sent it 43 times before signing his call, which he modestly sent only 4 times. This is a fine example of procedure NOT to follow.

If that operator, and all the other endless CQ'ers, would only stop a minute and think how tiring repetition gets he would probably mend his ways and then get a lot more answers. Possibly quite a few others heard that CQ and tuned elsewhere, not wanting to waste time listening to some guy practice code. He probably misses quite a lot of good QSO's that way. Here's the moral to that, fellows:

CQ for answers, not for practice!

Next, we come to the ham that has a practice of making combinations of letters; that is, running the code groups together. The next signal I listened to after the persistent CQ'er was one that was calling "7GA - - -". After finally deciding that the "- - -" should be deciphered to "MW" I discovered that he was calling W7GAM. I doubt if W7GAM would want to answer as he would probably be suspicious that the W8 would have quite a number of defects in the worthy art of sending good code. In other words, he is a brass flounderer, not a brass pounder.

A few other common combinations are the sending of "P" for "AN" thereby making "PD" out of "AND"; "6" for "TEH"; "-----" for "OF"; and one that is heard practically every day: "NST" for "TEST"! The sending of combinations is a common fault with nearly every operator, and although some of this may sound trivial to you, remember, it's the little things in sending code that spell the difference between a good operator and a "lid." A good thing for beginners to remember is that if you can't copy your contact because he is sending too fast, don't hesitate to tell him so. He will appreciate it a lot more than all your R's when you don't get what he says but receipt for it. It's not much fun to send a lot of dope to the winds. Don't send "R" when you haven't received the other fellow's transmission.

Don't repeat unnecessarily. It's tiresome to listen to you send the signal strength report three times unless it happens

* 1579 Southern Ave., Memphis, Tenn.

to be 599 and the receiving operator is extremely egotistical if he hasn't received your QTH the first two times he probably won't get it the next two times you repeat.

Another thing: you may want to become a member of the celebrated "Rag Chewer's Club," but don't try to get the required half-hour QSO in one transmission! I've stood by for as long as 45 minutes while some guy proceeded to elucidate to his heart's content. And the amazing thing is that I still had strength enough to reply, although I had already forgotten most of what he said.

Those of you that use self-excited rigs with frequency wabulation and TI notes might have taken wrong something 1 once read in the April 1933 issue of *QST*. It went something like this: "Show your independent spirit—R.A.C. forever. . . ." etc. Yeah, but brother remember—for everyone person that is admiring your "independent spirit" and R.A.C. signal, there're 10 guys cussing your 10 Kc. wide QRM and flea bitten hide. That little gem was published in the *April Fool* section of *QST* in case you didn't notice. It was under the caption "*Goaf* Operating."

Here are my "10 commandments of ham radio." Give 'em a try and see how well they work:

1. Avoid CQing without signing your call frequently. The A.R.R.L. method of sending CQ three times and signing your call three times is best.

2. Avoid sending "combinations" of letters, thereby helping yourself to get the idea across to the other fellow easily.

3. Tell the speed demon he is going too fast if you can't copy the speed.

4. Avoid unnecessary repetition of reports, QTH, etc.

5. Avoid long transmissions; who knows, QRM may have covered you up and you may just be wasting electricity.

6. Conform with F.C.C. regulations.

7. Use "R" when you have received the other fellow's transmission completely, not when you haven't.

8. Use ham bands for pleasure and not for profit.

9. Remember that the age of mental telepathy is not yet here, so the only way you can get your dope across is with good clean cut sending.

10. You are in ham radio for the pleasure in it—so is the other fellow. Help him get pleasure from working you and you will get yours automatically.

O.R.S./O.P.S. '37-'38 All-Season Competition Winners

VIC CLARK, W6KFC, was first-prize winner (NC-81X receiver) in the O.R.S. All-Season Competition for the best overall performance in the seven-month period, October '37-May '38. Scores were based on a consideration of (a) Traffic totals; (b) quarterly party scores; (c) number of A.R.R.L. "official list" stations (ORS, OPS, Directors, SCM's, RM's, PAM's, etc.) worked between the dates of quarterly parties, and (d) consistency of reports to the S.C.M., new appointees enrolled, contributions to *QST*, etc. W6KFC's points totalled 1216.

Second high was W2JHB with 1002 points, third high W4DWB, 728, followed in turn by W4PL, W6IOX, W6LMD, W8OFO, W1IOT, W5EOE and W7CCR, comprising the "high ten." W4PL led in Traffic with a total of 12,563, handling more traffic during the seven-month period than any other single-operator station. W6IOX was second in Traffic. W4DWB made the best showing in the quarterly parties, W2JHB was well out in front in *QST* contributions, etc., and W6KFC worked the most stations "between parties." Congratulations to all winners!

In the Official Phone Station group, George R. Stray, W6IWU, won the All-Season award for the best performance, choosing as his prize a D-5-T high-impedance dynamic microphone. Scoring was for (a) station data submitted; description of equipment, good engineering points, etc.; (b) quarterly O.P.S. test performance; (c) number of "official list" stations worked between quarterly tests, and (d) work in various A.R.R.L. activities, enrollment of new appointees, article contributions, etc. The arrangement for low power operation, and good engineering features brought

out in W6IWU's report of arrangements and adjustment helped him to lead the first classification (a). His total score was 1302.

W8LUQ was second high O.P.S. with 1239, W9TTA third with 547. W8LUQ, in addition to Section leadership of quarterly tests for three consecutive times, made two national "firsts" and one "second", making his standing highest under classification (b). W6IWU won most points under classification (c), W9TTA being second in this factor. It was a well fought contest, with splendid rivalry. Congratulations, all!

Aircraft Warning Service

While on duty at Fort Bragg, N. C., October 2nd-15th, in connection with the Joint Antiaircraft-Air Corps Exercises, Capt. David Talley, Sig-Res., W2PF, organized a network of amateurs in the eastern part of North Carolina to function as an Aircraft Warning Service Radio Net. This net was used in conjunction with the 275 civilian and Reserve Officer observers to report sighting or hearing aircraft. Some two dozen amateur operators participated and were of considerable value. When a "blackout" was ordered on the night of October 13th, amateurs were used to notify many towns which had no telephone observers.

L. I. Railroad Emergency Net

George F. Gaynor, W2AZM, A.R.R.L. Regional Emergency Coördinator, has organized an emergency network for the Long Island Railroad. Operation is in the region 3550-3590 kcs. Organization is by counties and by towns. Stations are needed in every town where there is a Station Master of the L. I. R. R. Volunteers are requested and should apply to W2AZM, 214 B. 117th St., Rockaway Beach, N. Y., for complete details.

Glacier Park District Convention

One hundred and fifteen licensed amateurs, and more than 250 persons, including YF's, YL's and friends, attended the Glacier Park District Convention at Two Medicine Camp, Glacier National Park, Montana, July 16th and 17th. It was a busy week-end, thoroughly enjoyed by all. Amateurs were present from such outside points as Canada, North Dakota, Idaho, Pennsylvania, Michigan, Nevada and Washington. Saturday activities featured short speeches, a lost treasure hunt with 56-Mc. sets, community sing around the camp fire, and motion pictures of the Park and the 1937 convention. 1.75- and 3.9-Mc. rigs were operated from the Park and on the Continental Divide atop Going-to-the-Sun Pass until daylight Sunday. Sunday morning found the gang engaged in taking advantage of a boat trip to the upper end of Two Medicine Lake, from there hiking to view the Twin Falls. A tug-o'-war, soft ball game, an auction sale, bingo for the ladies, and much general hamfesting made the day pass quickly. The affair was climaxed, as are most successful hamfests, by the prize distribution. Plans are already afoot for the 1939 gathering, to be held at Avalanche Basin Camp, the third week-end in July. Those at this year's affair will surely be back for more.

Briefs

Here is one of those "things that couldn't happen but did." One afternoon during September W1JRW and W2KFA heard W2HHY and W2KMX on opposite ends of the 7-Mc. band calling the same station (W8LGY) at the same time, with the same signal strength, note, speed, fist, etc.!

W3ERP and W3FIS on June 5th/6th had a rag-chew lasting 4 hours and 5 minutes (9:34 P.M., 5th, to 1:39 A.M. 6th). This was on 3.6-mc. c.w.

For the fourth consecutive year amateur radiophone operators cooperated with the Los Angeles Fire Chiefs and Junior Chamber of Commerce members during National Fire Prevention Week. Fire officials, gathered at various amateur stations, swapped yarns and told what they were doing along educational fire-prevention lines. W6AM, Long Beach, Calif., this year acted as key station. Others participating in the hook-up on October 13th were W3GUW, Washington, D. C.; W5FDD, Dallas, Texas; W9RUK, Chicago; K6NZQ, Honolulu; W9UJS, Denver, Colo.; and W6DZX, Salt Lake City, Utah. Also cooperating were W6MYO, W1LI, K6ILW, and VE4EO.

Communications Act Violations

A series of cases involving violation of the Communications Act of 1934, as amended, are now under investigation by the F.C.C. or pending in the Federal courts throughout the United States. A recent case to be completed is that of Harry W. Smith, who entered a plea of guilty on October 18, 1938, in the United States District Court, Boston, Mass., to an indictment on two counts charging unlawful radio operation in violation of Sections 301 and 318 of the Communications Act of 1934, as amended. On the first count the defendant was fined fifty dollars. On the second count the Court sentenced defendant to be imprisoned for six months but suspended such sentence and placed the defendant on probation for a period of one year. Smith, an unlicensed operator, had been bootlegging amateur calls and using objectionable language on the air.

In Australia, a citizen who talked to relatives in England through an amateur station was convicted and fined £50 and the ham (VK2YQ) had his license cancelled. The charge was "use of an amateur station for purposes other than those of an experimental nature."

Andean Anthropological Expedition

The Andean Anthropological Expedition is a non-profit organization incorporated for the advancement of science. The Expedition is sponsored by the Arizona Anthropological Association and the University of Arizona, and has the endorsement of twelve other universities, nineteen governmental agencies and eleven museums, besides many leading scientists. Under the Directorship of Dr. Robert E. Solosth, F.R.G.S., the Expedition will conduct its investigations on the eastern slopes of the Andes mountains on the headwaters of the Amazon River in Ecuador and Peru. The first base headquarters in Ecuador will be established at an altitude of 3500 feet. Here permanent headquarters will be constructed to house the Expedition personnel. Radio equipment will be installed to maintain communication with the United States and the various field parties. Lloyd M. Demrick, W6HJX, is in charge of the radio set-up. He writes that they expect to depend a great deal on amateurs to handle traffic "back home." Radio equipment will include a 15-watt portable with hand-cranked generator for power, and a 100-watt rig powered by a gasoline driven generator. The exact Expedition sailing date has not been set but this information, together with the call letters, frequency and operating times, will appear in *QST* as soon as available.

On or about December 10th the S.S. *California*, KDRC, whale oil boat, will leave Port Arthur, Texas, for the Antarctic Ocean, on a voyage of about four months. Radio operator Rhea Johnson, W9AM, will have a rig on 28-Mc. 'phone and c.w., and hopes to make many contacts with amateurs from the Antarctic. Watch for W9AM on 28 Mc.

American Emergency Net

W1PI, Hyde Park, Mass., is Net Control Station of the American Emergency Net, a group of amateurs who are

training themselves for emergency operation. A second district 7-Mc. section of the A.E.N. drills every Wednesday at 9:30 p.m. and Sunday at 10:30 a.m., with W2JVK, Brooklyn, N. Y., as control station. W2JVK operates on 7282 kc. and covers the entire band for calls from new members. If interested, tune to 7282 kc. at the specified times and listen for instructions.

Amateur Service

The B.P.L. list in *QST* each month tells only a part of the story. There are a number of outstanding operators, particularly on the West Coast, whose available time is so used up in message work that they have time for little else. Ask their wives! These men, together with those who find time to report their monthly activities, form a group as outstanding as the Emergency Gangs which step into catastrophic pictures from time to time. The DX-TFC group, however, is slightly different in that it operates full speed all the time and never stops.

To those who enjoy traffic work above all else, finding a place in this DX-TFC group is a natural step. In rendering a continuous service of this sort, more than usual accuracy is necessary all along the line. For really fast service, the ideal is to have a minimum number of relays, with immediate mailings from the most desirable point. Those who specialize in local routes are often disgusted because some DX-TFC station will not break down and schedule them for local distribution. DX-TFC volume generally allows little time to run other schedules.

Of the two types of circuit, DX and Local, the DX also appears to be the most accurate, probably due to an increased feeling of responsibility on the part of the men involved. However, too often those working DX-TFC are inclined to feel too "highhat" to ask for repeats where there is the slightest doubt. Pride in working this DX-TFC cannot be justified if personal feelings are allowed to creep in and interfere with accuracy. The man who will not "work like a dog" to get it right, is a millstone around the necks of everyone else working the circuit. A service, like a chain, is as strong as its weakest link, and cannot be entirely successful unless every link is above reproach.

Whether we acknowledge it or not, there is in us all a latent urge to serve others. Those of us who are hams have a magnificent medium for so doing. But to be really satisfactory, and not just "mess around," our whole hearts must be in it FOR THE SERVICE AND NOT FOR THE SATISFACTION.

—W3QP

1.75-Mc. DX

G2PL advises via W1BB that he will be on 1730-ke. c.w., Sundays, between 0500 and 0600 GT (Midnight EST, Saturdays to 1:00 A.M. EST, Sundays) beginning October 9th and continuing every Sunday through January, 1939. He will be looking for DX contacts, both phone and c.w. G2PL also reports VS3RD on 1.75 Mc. at odd hours, attempting DX contacts. A series of 1.75-Mc. tests for February, 1939, are being arranged by G6FO and W1BB. Full data later.

Club Broadcast—1310-ke.

The San Joaquin Valley Radio Club of Fresno, Calif., is presenting monthly broadcasts over KARM, 1310 kc. These broadcasts are on the Wednesday before the club meeting, which falls on the second Friday of each month. The time is 11:30 p.m. to Midnight, PST. The program consists of club news, A.R.R.L. news, announcements, interviews, chatter, etc. Everyone is invited to listen in and, if possible, attend the broadcast at KARM.

O.B.S.

The following is a supplement to the list of A.R.R.L. Official Broadcasting Stations in October *QST* (page 71): W1DWP, W3GCU, W4CRG, W6GNV, W7BOZ, W7CZY, W7GBF, W8IAI, W9AUH, W9IAW, W9YVF, VE1MK.

BRASS POUNDERS' LEAGUE

(September 16th-October 15th)

Call	Orig.	Del.	Rel.	Extra Del. Credit	Total
W4PL	17	42	1384	23	1466
W6JVK	31	32	1110	23	1204
W2SC	78	77	956	52	1163
W5BN	275	125	345	345	1090
W1KPW	8	545	380	—	933
W6DH	32	114	620	114	880
W1KMS	496	26	283	25	830
W2CGG	45	122	536	100	803
W1AKS	31	77	688	43	739
W3CZ	40	79	519	79	717
W3EML	92	195	184	183	654
W1BOB	32	163	282	157	634
W6TH	168	141	180	104	593
W7EBQ	—	—	592	—	592
W1HNE	38	2	534	2	566
W8QGD	112	77	307	40	536
W6LLW	10	64	426	21	521
K6NXTD	257	112	48	102	519
W5DKR	54	—	216	216	508
W3BWT	59	39	379	25	502

MORE-THAN-ONE-OPERATOR STATIONS

Call	Orig.	Del.	Rel.	Extra Del. Credit	Total
KA1HR	719	370	640	—	1729
W6OW	122	154	1034	108	1418
W1INW	130	—	1007	274	1411
W1CPV	325	275	192	275	1067
W1AW	148	180	410	300	1038
W1KFN	176	112	346	84	718
W9BNT	98	129	397	13	637
W1DND	111	12	204	12	329
K5AA	265	106	68	81	520

These stations "make" the B.P.L. with total of 500 or over. One hundred deliveries+Ex. Del. Credits also rate B.P.L. standing. The following one-operator stations make the B.P.L. on deliveries. Deliveries count!

W3QP, 300	W2JZX, 177	W1JXP, 121
W6ELW, 250	W9ESA, 172	W5EOE, 120
W2OQ, 237	W1KH, 168	W1BMW, 114
W1KCT, 235	W1KIN, 151	W2GVZ, 108
W1EQY, 233	W7APS, 150	W1CZL, 113
W2JHB, 217	W1GFN, 138	W2JJD, 101
W2DRQ, 212	W5CEZ, 131	More-than-one-opr.
W6ML, 188	W1HRE, 128	W1INF, 113
W6JTV, 181	W6FA, 126	

A.A.R.S.

WLTR (W9RAM) made the B.P.L. on 102 deliveries.

MORE-THAN-ONE-OPERATOR STATIONS

Call	Orig.	Del.	Rel.	Extra Del. Credit	Total
WLM(W3CXL)	158	183	2905	89	3335

A total of 500 or more, or 100 deliveries Ex. D. Cr. will put you in line for a place in the B.P.L.

Police Operators Net

3715 kc. is the official gathering-place for those amateurs who by profession are operators of Police Radio Stations. "QPO" is the general call of the Police Operators Net, now being organized on that frequency. The primary purpose of the net is fraternalism . . . to afford police operators the opportunity to more easily contact one another and exchange the word of the day. A secondary purpose is to provide an auxiliary emergency network, one which would coordinate police facilities with amateur facilities. One of the leading lights in the organization of the P.O. Net is Ken Conroy, W8DYH. He invites all police operators to get in touch with him by mail at 18030 Waltham Ave., Detroit, Mich., or get on 3715 kc. and call "QPO."

Banquet-Hamfest

On Saturday evening, December 10th, the Mid-Hudson Amateur Radio Club will hold the Fourth Annual Banquet and Get-Together of Hams of the Hudson Valley. The Place: Nelson House, Poughkeepsie, N. Y. The Time: 5:00 p.m., Registration, 6:30 p.m., Banquet. The cost is \$1.50 per fellow (stag). George Brown, W2CVV, of the Radio Department of the General Electric Co., Schenectady, will be the main speaker. There will be a turkey dinner, a number of door prizes and plenty of good fellowship and ham spirit. Reservations should be sent to Don Love, W2BJX, 358 Church St., Poughkeepsie.

A.R.R.L. DX Century Club Rules

The following have submitted proof of contacts with 75-or-more countries.

(1) All contacts must be made with stations working in the authorized amateur bands using amateur calls.

(2) In cases of countries where amateurs are licensed in the normal manner, credit may be claimed only for stations using regular government-assigned call letters. This shall not militate against claimed credits for contacts prior to publication of this section that might otherwise have been claimed earlier.

(3) All stations contacted must be "land stations" . . . contacts with ships, anchored or otherwise, cannot be counted.

(4) All stations must be contacted from the same state or call area, where such areas exist, or from the same country in cases where there are no call areas.

(5) The A.R.R.L. list of countries, printed periodically in *QST*, will be used in determining what constitutes a "country." (January, 1939 *QST*, will contain the revised up-to-date list.)

(6) In cases of countries no longer in existence, credit will be allowed for these, if they were recognized as separate countries by A.R.R.L. at time of contact.

(7) Confirmations must be submitted direct to A.R.R.L. Headquarters for all countries claimed. Confirmations from foreign contest logs may be requested in the case of the A.R.R.L. International DX Competitions only, subject to the following conditions:

(a) Sufficient confirmations of other types must be submitted so that these, plus the DX Contest confirmations, will total 75 or more.

(b) Look up the contest results as published in *QST* to see if your man is listed in the foreign scores. If he isn't, he did not send in a log and no confirmation is possible. Logs for the 1935, 1936, 1937 and 1938 contests only are available. Results of these contests appear in the September, 1935, September, 1936, October, 1937 and November, 1938, issues of *QST*.

(c) Give year of contest, date and time of QSO.
(d) In future DX Contests, do not request confirmations until after the final results have been published, usually in one of the early fall issues. Requests before this time must be ignored.

(8) Contacts may be made over any period of years, and may have been made any number of years ago, provided only that all contacts be made from the same state or call area (or country, where no call areas exist) and by the same station licensee; contacts may have been made under different call letters in the same area (or country), if the licensee for all was the same.

(9) The Century Club award and *QST* listing for confirmed contacts with 75 or more countries is available to all active amateurs, everywhere in the world.

(10) Following the first listing of any station in *QST*, confirmations from additional countries may be submitted as received, and the original listing will be changed in subsequent lists.

(11) Stations reaching the 100-confirmations mark will automatically be enrolled in the DX Century Club.

(12) Sufficient postage for the return of confirmations must be forwarded with the application. In order to insure the safe return of large bunches of confirmations it is suggested that enough postage be sent to make possible their return by *First Class Mail, Registered*.

(13) Address all applications and confirmations to the Communications Department, A.R.R.L., 38 La Salle Road, West Hartford, Conn.

(14) In submitting confirmations they should be accompanied by a list of claimed countries and stations representing each country to aid in checking and for future reference after your confirmations have been returned to you.

We are again printing the Century Club rules, with clarification of certain points, since it has been some time since this information appeared in *QST*. Kindly refer to the above in preparing to submit confirmations. This will answer practically every question you may have. The rules

as they now stand are effective with publication of this issue of *QST*.

MEMBERS, DX CENTURY CLUB

G6WY (No. 5) . . . 140	W9TJ (No. 67) . . . 108
W1TW (No. 3) . . . 133	W1FH (No. 71) . . . 108
W1SZ (No. 7) . . . 131	W6HX (No. 21) . . . 107
W6GRL (No. 15) . . . 129	W9EF (No. 44) . . . 107
W6CXW (No. 4) . . . 127	J5CC (No. 46) . . . 106
W6CRA (No. 1) . . . 126	PA0XF (No. 43) . . . 105
W2GTA (No. 11) . . . 125	VK5WR (No. 49) . . . 105
W6ZT (No. 12) . . . 125	W2HHF (No. 54) . . . 105
ON4AU (No. 40) . . . 125	W4BPD (No. 70) . . . 105
W1TS (No. 9) . . . 124	W9KA (No. 42) . . . 104
W8DFH (No. 14) . . . 124	W6EVT (No. 51) . . . 104
GZQ (No. 6) . . . 123	W9ADN (No. 61) . . . 104
W2GT (No. 32) . . . 122	W8BKP (No. 65) . . . 104
W1BUX (No. 2) . . . 118	E1SF (No. 19) . . . 103
W1LZ (No. 10) . . . 118	W5VY (No. 38) . . . 103
W8DHC (No. 27) . . . 118	G6PK (No. 45) . . . 103
HB9J (No. 13) . . . 117	W6FZL (No. 48) . . . 103
W9KG (No. 16) . . . 115	W3EYV (No. 55) . . . 103
W9ARL (No. 18) . . . 115	W4C8Y (No. 20) . . . 102
W6KIP (No. 28) . . . 115	W1JPE (No. 66) . . . 102
W8BT1 (No. 58) . . . 114	F8RJ (No. 8) . . . 101
W2UK (No. 33) . . . 113	W2CJM (No. 47) . . . 101
W5BB (No. 37) . . . 113	W2CYS (No. 52) . . . 101
W8LEC (No. 25) . . . 112	VK3KX (No. 57) . . . 101
W1DF (No. 29) . . . 112	ZL1HY (No. 59) . . . 101
W60QF (No. 30) . . . 112	W4CEN (No. 60) . . . 101
G6RH (No. 36) . . . 112	W1ZB (No. 62) . . . 101
W6GRL (No. 50) . . . 112	W1WV (No. 69) . . . 101
W8D8V (No. 17) . . . 111	W3DDM (No. 72) . . . 101
W90SL (No. 23) . . . 111	W20A (No. 73) . . . 101
W7AMX (No. 26) . . . 111	W3EPU (No. 74) . . . 101
W7IMP (No. 22) . . . 110	W4AJX (No. 75) . . . 101
W8PST (No. 35) . . . 110	W6DOB (No. 76) . . . 101
W2B8W (No. 39) . . . 110	W9FS (No. 77) . . . 101
ON4AU (No. 31) . . . 109	G6CL (No. 24) . . . 100
W6ADP (No. 34) . . . 109	G5RV (No. 64) . . . 100
W6GDH (No. 41) . . . 109	W2C8Y (No. 68) . . . 100
W8EDP (No. 53) . . . 108	W4CYU (No. 78) . . . 100
W3EMM (No. 58) . . . 108	W2DC (No. 79) . . . 100
W8ADG (No. 63) . . . 108	W2GVZ (No. 80) . . . 100

The following have submitted proof of contacts with 75-or-more countries.

W1DUX . . . 99	VE2EE . . . 89	Z2JJ . . . 82
W2AAL . . . 99	W3JM . . . 88	SP1AB . . . 82
W2AG . . . 98	W8CD . . . 88	W1EPT . . . 81
W3GAU . . . 98	W8NJP . . . 88	W3EMA . . . 81
G2TR . . . 98	PA0QZ . . . 88	W9FLH . . . 81
W8FRY . . . 97	W1GCK . . . 87	W9RCQ . . . 81
F8RR . . . 97	W3ZX . . . 87	W1GNE . . . 80
W2AX . . . 97	W8AAJ . . . 87	W2ALO . . . 80
W1CG . . . 96	W8AFH . . . 87	W3EAT . . . 80
W8EUY . . . 96	G2DZ . . . 87	W3EPR . . . 80
W4DRD . . . 95	W4CCH . . . 86	W3GEH . . . 80
PA0QF . . . 95	W6GHU . . . 86	W8DGP . . . 80
W2CBO . . . 94	W6ITH . . . 86	G6ZO . . . 80
W1GDY . . . 93	W8AAJ . . . 86	W1EWD . . . 78
W2ZA . . . 93	W8AFH . . . 86	W8AAT . . . 78
W8E8X . . . 93	G2DZ . . . 86	W8EJN . . . 78
G8RH . . . 93	W4MR . . . 85	W8MTY . . . 78
W1FTR . . . 91	W5ASG . . . 85	W9UM . . . 78
W1ZI . . . 91	W6FKZ . . . 85	G6YR . . . 78
W3E8S . . . 91	W1HX . . . 84	VE2GA . . . 78
HB9AB . . . 91	W2TOP . . . 84	W1CA . . . 77
G8NF . . . 91	W8AGV . . . 84	W3KT . . . 77
HB9BG . . . 91	W4CFD . . . 84	W6TT . . . 77
W1BGY . . . 90	W8BSF . . . 84	W2DSB . . . 76
W1RY . . . 90	G5BD . . . 84	W6LDJ . . . 76
W8HAM . . . 90	G5QY . . . 84	W8LZK . . . 76
W8KTV . . . 90	VK68A . . . 84	Z5ZQ . . . 76
SUITW . . . 90	W2RYP . . . 83	W3CET . . . 75
W8OXO . . . 90	W2GRG . . . 83	W4TZ . . . 75
W1ADM . . . 89	W3AIU . . . 83	W8AN . . . 75
W5KO . . . 89	W3OP . . . 82	PA0JMW . . . 75
W8AG . . . 89	W6CFP . . . 82	
W8LJ . . . 89	W6CWV . . . 82	Radiotelephone
W8KKG . . . 98	W9OVU . . . 82	W2IXY . . . 77

Corrections, DX Contest Results

In the November *QST* list of scores, 1938 A.R.R.L. DX Competition, W9FHU's call appeared erroneously in the Wisconsin C.W. tally as W9FNU. In the Md.-Del.-D. C. list, W3FEW was shown as W3EEW. W6CIS, shown as using more than 500 watts, should have been reported in the 100-to-500-watt classification. W5DM, Northern Texas C.W. winner was listed as W5DN.

How's DX?

How:

We don't intend to turn this into a cooking column, but we ran into a recipe the other night that is worth passing along. It was originated by some of the lads out on the west coast a few years back. We got our first taste of it just recently—it was the first time anyone had prepared it here in the hurricane belt—and liked it a lot. The ingredients for this "DX Cocktail," as it might be called, are simple and readily available: an active radio club with a predominance of DX men, to sponsor the thing; invitations to the DX men within a hundred miles or so, a program devoted to DX subjects like antennas and such, and a suitable meeting place and a popular chairman to handle the thing. Toss the ingredients together and prepare to enjoy yourself. It's as easy as that. You'll notice that this recipe differs from most in that there's no mention of "mix well." That's one thing you don't have to worry about. Just get a hundred or more DX men together, and they mix from the word "hello." The only thing you might not like about the DX Cocktail is that there are only five hours from 8 P.M. to 1 A.M.

We tasted the thing at Bridgeport—they call them "DX Round-Ups," too (as though you hadn't guessed!). They're "peachy stuff," if we may be allowed to coin a phrase, and are recommended highly.

Where:

We learn that the F.C.C. is beginning to assign the new Pacific Island prefixes, and naturally you'll want to know what they are. To simplify, we'll give you all the possessions prefixes:

- K4 Puerto Rico
- KB4 Virgin Islands
- K5 Canal Zone
- K6 Territory of Hawaii
- KA Philippine Islands
- KB6 Guam
- KC6 Wake group
- KD6 Midway Islands
- KE6 Johnston Island
- KF6 Baker Island, Howland Island, Am. Phoenix Islands
- KG6 Jarvis Island, Palmyra group
- KH6 America Samoa
- K7 Alaska (including Pribilof Islands)

Incidentally, this will explain to you why we haven't mentioned which Pacific islands are grouped with which for the Century Club—we wanted the grouping consistent with the F.C.C. grouping. The countries list (we'll repeat it again next month) will group them as above G6WY says that the genuine ZB2A (14,300 T9) operated from September 29th to October 14th, at which time he returned to England. So if you got him during that time you got Gibraltar, if not, you added to your list of FLY's. Ham says that the following are almost certain to be phoney, too: ZA1D, TA2A, AR8PK, VQ9AA, ZD7A, ZA1B, VQ5AB, LX1AX, VS3OL and ZA2E. VQ4CT comes in from the wrong direction and is probably in Central America. Incidentally, WY never counts a country until he has a card from there, on account of all the BL's on W9TJ gives the QTH of OY4C as E. Nishen, Fernis, Faroe Islands A lot of the lads are hoping that CR6AI (14,150 T7) is legit. He gives his address as J. J. Chavez, Box 62, Mossamedes, Angola. You might be smarter not to mention radio on the envelope, although we're not sure. W6ITH says the Z8 gang are working a CR6AB on 20' phone In a nice letter, AC4YN (14,120 T9) says that he has received a number of cards from W's claiming QSO's but he still hasn't worked North America. His beam points towards Europe, worse luck G61A (14,100) is on around 2200 GMT on c.w. if you want Isle of Man, according to W2GVZ and W8BKP The cards bounced back

from the addresses we gave for ZA1C and LX1AG. Soddy W8PHD says he heard J2KG working J9CA, who would be a honey if he ever listens for W's. We didn't get the frequency PX2D (14,410 T6) might be legit., although the R.E.F. knows of no active station in Andorra W9UAU says cards to VR3A also bounced. Bob got a letter from the Postmaster down there saying the only station on Fanning is a very low-power VQ used for inter-island communication BB1AA (14,440 T8), worked by a flock including W2DKF, W5KC, CM2BA, W1BGC and W9AMP, claims to be 6000 miles SE of Argentina, undercover. Said he'd write to A.R.R.L. confirming QSO's but he hasn't yet, and the corner cigar store is giving 100-to-1 he doesn't Believe it or not, W2GTZ, W8DWV and W3OP finally got cards from FP8PX! Heck, we don't know how they did it either Guatemala's really getting on the air these days. W6DOB grabbed TG9AS (14,395 T7), who gives his address as Box 450, Hotel Continental, Guatemala City; and TG9BA (14,000) is Walter Bay, Chalet Krolik, Guatemala City That ZP2P reported some time ago turned out phoney W2IYO gave the address of OQ5AV (14,120 T6) as Derungs Service, Voies Navigables, Leopoldville, Belgian Congo W4CEN grabbed off F8SAA (14,370 T awful) who gave his QTH as Norsup, New Hebrides. That doesn't check with the Call Book, and Tom's wondering around with his fingers crossed The J8's have been good recently, what with J8CA (14,345 T9), J8CD (14,425 T8) and J8CG (14,360 T8) coming through in the east W2GTZ snagged YJ2FF (14,460) in the middle of the evening W6NJP heard ZK2AA (7145), which is a glimmer of hope for that part of the Pacific W9AMP heard ZD1AA (14,400 T6) By the time this gets to you and you get to it, FB8AB will be at St. Paul and New Amsterdam Islands signing XF88AB (14,360 T9), so don't let the call bother you There's a YA5RX (14,420 T7) on the air who says to QSL via A.R.R.L. because he's undercover. We haven't heard from him yet, however The N. J. gang has been knocking off XU4XA (14,280 T9) during the evening. The story is that he's about 1500 miles inland over there.

When:

Take off the phones a minute and look out the window. Yes, it's getting near winter, and that means 3.5-Mc. DX. To start the cards rolling, G2PL says, via W1BB, that he'll be on Sundays at 0600-0800 GMT through up to February, looking for W5, 6 and 7 and VE4 and 5. W6GRL worked G16TK on 80 last year, so it ain't impossible W8DHU worked D4ORT (3520 T9), PAOQQ (3510 T9) and F3CN (3600 T9) around midnight on a Saturday night a short time back.

There's a lot of good stuff to be picked up on 40. W8JSU knocked off YS6NJ (7175 T9x), VP2LC (7175 T9x) and HH2LD (7130 T9x), and W6PGL got ZS5B (7190 T9), KA4LEH (7050), KA1AX (around 7170) and PK4KS (7025). W8LZK worked KA1AX at 7035 kc., and says 1AX looks for DX every night around 1130 GMT W7ENW kept a sked with LU7AX on 40 with good signals both ways W3ATR says Europeans are a cinch, since apparently no one on 40 goes after DX, and he's raised 'em in all parts of the band from the low end. Europe's best around 6 P.M. or 1 A.M., and South America comes through around 10-11 P.M. So there's our case, gentlemen. Give it a whirl.

And don't pass up 10. Africa and Europe is coming through from Maine to California, with stuff like ZE1JI, FA8IH, ZS1C, IHMH, SU1CH, VQ3TOM, LA4P, VS6AL, YS2LR and TF5C, according to W6MCO, W4MR and W2GMM. W1DF grabbed VU2AN, in Baluchistan. And if you just wanna be friendly, there's a good gang of W's on there on Sundays to fling chin with.

ELECTION NOTICES

W6DOB does a job on 20, what with VS7RF (14,340 T9x) and a number of VU's in the AM, and OX3X (14,430 T7), ZB1R (14,320 T9), CTLJS (14,410 T9) and UK8IA (14,350 T7) At W2IYO it's things like CR7BT (14,100 T9), PK6XX (14,004 T9x), CN1AA (14,100 T7), VU7FY (14,385 T9) and VQ2GW (14,100 T9x) that keep Dave contented W4BPD says DX isn't very good, and then lists VQ2PL (14,405 T8), VQ3HJP (14,405 T7) and XU8CM (14,270 T9) among the worked, and VU2FO (14,400 T9x), YI2BA (1r, 220 T7), HS1BJ (14,080 T9x) and YS1AF (14,400 T9x) in the heard department. Well, maybe DX will pick up a little later on W6KUT got on again and worked CR7AD (14,100 T9), VS2AL (14,355 T7), PJ1BV (14,440 T9) and CPIAA (14,430 T9) W4CEN says G8MF (14,390 T8x) in the Channel Islands is on during the mornings. Others at Tom's include F18C (14,420 T9), VS7RP (14,265 T9x), CR7AF (14,275 T9x) CR7AG (14,315 T9x), UB1B (14,410 T9) and J5CC (14,290 'phone) W2AER submits XZ2KR (14,220 T9), VQ4CRI (14,450 T7) UK8IA (14,450 T8), VU2AN (14,070 T9) and VQ2HC (14,070 T9), while W2BHW adds VS7RA (14,010 T9), VU2EU (14,335 T9), PK3EM (14,350 T8), OX7ZL (14,035 T7) and VQ2MI (14,325 T9) to his worked list W2HHF sends in his usual nice list, with ZD4AB (14,350 G9), YV8AA (14,310 T8), PK1TT (14,360 T9), KALFG (14,350 T9) and XU8NR (14,320 G8) among the worked, and XU6AG (14,355), VK9DK (14,360), K6ODC (14,030) and ST6KR (14,270) heard W5BB says K6HCO (14,335 T9) on Enderbury Island, Phoenix group, is on every P.M.

What:

A number of the gang put their approval on the "C" method of comparing DX signals (reported here last month) and said they're going to start using it. We'd like to hear further on it, one way or the other.

Who:

W1WV, that ole "G man," worked his 1000th G and received his 100th card for the CC on the same day W6NPU got down on 10 and gave GM6RG and ZS6DY their first Utah, for WAS K6OJG from Guam is in the States now. The address is C. R. Spicer, 1332 Geary Street, San Francisco W8JDB says K6OQV (14,100) needs Vt., S. C. and Mississippi for his WAS, and G5IV (14,355 T9x) needs Vermont for the same reason K4KD thinks CX2AJ should get together with himself. "MA" heard the T6 CX2AJ calling FB8AB at the same time that a T9 CX2AJ was calling CQ inside the band. The T9 one's the phoney VQ2HC offers to forward any and all VQ2 cards YV2CU has been hopping all over 14 Mc., and can be found in either end, depending on the way the wind is blowing ZS5J is building a rotatable extended double-Zepp for 20, which makes the span about 90 feet across, and is anxious to receive reports of his signal in various parts of the world. (Jeeves, stop pushing that lumber catalog in my face!) ZC6NX will be on 10 and 20 during the next DX Contest, according to his present plans VO6J in Labrador is no longer operated by VE2JQ, and cards now should go to VE2KD, 5694 Waverley Street, Montreal G6MK, who needs Nevada, N. M., and Colorado for y.k.w., thinks stations in those rarer states could precipitate a young landslide from DX by signing their state during a CQ, especially Nevada and New Mexico. He says that TA1CA (14,400 T8x) may be genuine W9FS suspects YA7XX and AC4YR of being the same phoney, and adds that J2KG (14,425 T8) is easy to work around midnight out there VP7NS is acting as QSL Bureau for VP7 W2AJL read about VO3X wondering about getting cards and thinks 3X is getting a taste of his own medicine. Now, boys ON4FQ needs Nevada and S. D. for the usual reason ST2CM will remain in Sudan for quite some time, corrects W9TJ W8ISK says that the e.o.o.'s slide around so much these days that they should be called "trombone oscillators." Yep, they certainly indulge in some fine jam sessions. (Ooh, a jitterbug!)

—W1JPE

To all A.R.R.L. Members residing in the Sections listed below: (The list gives the Sections, closing date for receipt of nominating petitions for Section Manager, the name of the present incumbent and the date of expiration of his term of office.) This notice supersedes previous notices. In cases where no valid nominating petitions have been received from A.R.R.L. members residing in the different Sections in response to our previous notices, the closing dates for receipt of nominating petitions are set above. In the absence of nominating petitions from Members of a Section, the incumbent continues to hold his official position and carry on the work of the Section subject, of course, to the filing of proper nominating petitions and the holding of an election by ballot or as may be necessary. Petitions must be in West Hartford on or before noon of the dates specified. Due to resignations in the Oregon and Hawaii Sections, nominating petitions are hereby solicited for the office of Section Communications Manager in these Sections, and the closing date for receipt of nominations at A.R.R.L. Headquarters is herewith specified as noon, Thursday, December 15, 1938.

Section	Closing Date	Present SCM	Present Term of Office Ends
Quebec *	Dec. 1, 1938	Stan Comach	Dec. 14, 1938
Saskatchewan	Dec. 1, 1938	Anzelo V. Astone	Dec. 15, 1938
Valley			
Nevada	Dec. 15, 1938	Edward W. Helm	June 14, 1937
Vermont	Dec. 15, 1938	Alvin H. Battison	April 15, 1938
Nebraska	Dec. 15, 1938	S. C. Wallace	Aug. 17, 1938
Mississippi	Dec. 15, 1938	J. H. Weems, Jr.	Oct. 1, 1938
Philippines	Dec. 15, 1938	George L. R. Reid	Oct. 15, 1938
Oregon	Dec. 15, 1938	Eugene E. Lovejoy (resigned)	
Hawaii	Dec. 15, 1938	Otis Hill (resigned)	
Louisiana	Jan. 3, 1939	Fred H. Brandaway	Jan. 14, 1939
Manitoba *	Feb. 1, 1939	A. L. R. Simpson	Feb. 15, 1939
No. New Jersey	Feb. 1, 1939	Eugene C. Read	Feb. 15, 1939
Arkansas	Feb. 1, 1939	H. E. Veltie	Feb. 15, 1939
North Carolina	Mar. 1, 1939	H. S. Carter	Mar. 8, 1939

* In Canadian Sections nominating petitions for Section Managers must be addressed to Canadian General Manager, Alex Reid, 109 Logan Ave., St. Lambert, Quebec. To be valid such petitions must be filed with him on or before the closing dates named.

1. You are hereby notified that an election for an A.R.R.L. Section Communications Manager for the next two year term of office is about to be held in each of these Sections in accordance with the provisions of the By-Laws.

2. The elections will take place in the different Sections immediately after the closing date for receipt of nominating petitions as given opposite the different Sections. The ballots mailed from Headquarters will list in alphabetical sequence the names of all eligible candidates nominated for the position by A.R.R.L. members residing in the Sections concerned. Ballots will be mailed to members as of the closing dates specified above, for receipt of nominating petitions.

3. Nominating petitions from the Sections named are hereby solicited. Five or more A.R.R.L. members residing in any Section have the privilege of nominating any member of the League as candidate for Section Manager. The following form for nomination is suggested: (Place and date)

Communications Manager, A.R.R.L.
38 La Salle Road, West Hartford, Conn.

We, the undersigned members of the A.R.R.L. residing in the _____ Section of the _____ Division hereby nominate _____ as candidate for Section Communications Manager for this Section for the next two-year term of office.

(Five or more signatures of A.R.R.L. members are required.) The candidates and five or more signers must be League members in good standing or the petition will be thrown out as invalid. Each candidate must have been a licensed amateur operator for at least two years and similarly, a member of the League for at least one continuous year, immediately prior to his nomination or the petition will likewise be invalidated. The complete name, address, and station call of the candidate should be included. All such petitions must be filed at the headquarters office of the League in West Hartford, Conn., by noon of the closing date given for receipt of nominating petitions. There is no limit to the number of petitions that may be filed, but no members shall sign more than one.

4. Members are urged to take initiative immediately, filing petitions for the officials for each Section listed above. This is your opportunity to put the man of your choice in office to carry on the work of the organization in your Section.

—F. R. Handy, Communications Manager

ELECTION RESULTS

Valid petitions nominating a single candidate as Section Manager were filed in a number of Sections, as provided in our Constitution and By-Laws, electing the following officials, the term of office starting on the date given.

Tennessee	William Harold Walker, W4DWS	Oct. 14, 1938
Michigan	Harold C. Bird, W8DPE	Oct. 15, 1938
Ontario	Fred H. B. Saxon, VE3SG	Oct. 15, 1938
West Indies	Mario de la Torre, CM2OP	Oct. 28, 1938
Kansas	Melvin D. Kirby, W9UEG	Oct. 29, 1938

Station Activities on page 88



CORRESPONDENCE

The Publishers of *QST* assume no responsibility for statements made herein by correspondents.

Tribute

Hartford, Conn.

The death of Ross A. Hull is deeply regretted by the members of the Hartford County Amateur Radio Association, many of whom were personal friends of Mr. Hull. By his friendly coöperation in helping many of us solve our problems, technical and otherwise, we have been placed under an indebtedness to him which we shall never be able to repay. Mr. Hull's untiring research has benefited, in one way or another, not only the radio fraternity but mankind in general. We of the Hartford County Amateur Radio Association extend our sympathies to his associates at the American Radio Relay League Headquarters and to Mr. Hull's family.

—*The Hartford County Amateur Radio Ass'n*

HOUSTON, TEXAS

PLEASE CONVEY OUR DEEPEST SYMPATHY TO FAMILY OF OUR LATE ROSS HULL. HIS DEATH IS A GREAT LOSS TO AMATEUR RADIO.

—*HOUSTON AMATEUR RADIO CLUB*

ST. PAUL, MINN.

PROFOUNDLY SORRY TO HEAR OF YOUR GREAT SORROW. SINCERE SYMPATHY.

—*THE ST. PAUL RADIO CLUB*

Columbia, S. C.

At its last meeting The Palmetto Amateur Radio Club, Inc., adopted the following resolution:

"Be it resolved that the Secretary of the Club extend to the Executive Committee and members of the Headquarters staff its deepest regrets at the untimely death of the Editor of *QST*, Mr. Ross Hull. His loss, coming as it does at the beginning of the season's activity, will be felt most keenly. His contributions to amateur radio, the League and to *QST* have made his name well known among amateurs, who mourn his passing."

—*The Palmetto Amateur Radio Club, Inc.*

Ridgewood, L. I., N. Y.

We wish to express our deepest sympathy at the untimely death of Ross A. Hull. A gap has been left in the ranks of "ham" radio that will be difficult to fill.

—*The Queens Radio Amateurs*

CAMDEN, N. J.

THE SOUTH JERSEY RADIO ASSOCIATION SENDS SYMPATHY ON THE BE-REAVEMENT OF ROSS HULL, TECHNICAL EDITOR OF *QST*. WE REQUEST THIS TELEGRAM BE FORWARDED TO NEAREST RELATIVES.

—*THE SOUTH JERSEY RADIO ASS'N*

CHICAGO, ILL.

WE AND ALL OTHER CHICAGO AMATEURS EXTEND SYMPATHY IN THE UNTIMELY DEATH OF ROSS HULL.

—*SOUTHTOWN AMATEUR RADIO ASS'N*

Baltimore, Md.

We are very sorry to hear the bad news of Ross' death and send our condolence. Amateur radio has lost a great friend.

—*Mike and Key Club*

CONCORD, N. H.

OUR TENDER DEEPEST SYMPATHY IN THE LOSS OF ROSS HULL.

—*MERRIMACK VALLEY AMATEUR RADIO ASS'N*

ROCHESTER, N. Y.

TO THE *QST* STAFF WITH THE DEEPEST REGRETS ON THE UNTIMELY PASSING OF ROSS HULL. A GREAT AMATEUR AND A GREAT GUY, HE DIED WITH HIS BOOTS ON. PASS OUR SENTIMENTS ON TO HIS FOLKS.

—*ROCHESTER AMATEUR RADIO ASS'N*

SYDNEY, AUSTRALIA

HULL'S LOSS INESTIMABLE. DEEPEST SYMPATHY.

—*ZERO BEAT RADIO CLUB*

MARICKVILLE, N. S. W., AUSTRALIA
WE DEEPLY REGRET UNTIMELY DEATH ROSS
HULL, A GREAT LOSS TO AMATEUR RADIO.

—N. S. W. DIVISION W.I.A.

Rapid City, S. Dak.

The members of the Black Hills Amateur Radio Club wish to convey to the Headquarters staff their deepest sympathy for the recent tragic death of Mr. Ross A. Hull. We know that his loss is a severe blow to the A.R.R.L. and to the amateur fraternity throughout the world.

Although it was not our privilege to know him personally, we were well acquainted with him through his work. His passing leaves a gap in the amateur ranks which will not soon be filled.

—Black Hills Amateur Radio Club

Milwaukee, Wis.

The Milwaukee Radio Amateurs' Club wishes to extend to Headquarters its deep regret in the loss of so fine a man as Ross Hull.

Will you please convey to his family our condolences and sincere sympathy.

—The Milwaukee Radio Amateurs' Club

New York City, N. Y.

At our last regular meeting, the writer was instructed to convey to you our sincere although somewhat belated condolences on the death of the Editor in Chief and Business Manager of *QST*, Mr. Ross A. Hull. The passing of Mr. Ross A. Hull will be keenly felt by amateur radio and by the members of the radio manufacturing industry.

It was my pleasure to know Ross personally and I know many members of our group were familiar with his achievements and we all keenly feel our loss.

—Sales Managers Club, Eastern Group
W. W. Jablon, Sec'y

Montreal, P. Q., Canada

We have learned with deep regret of the recent death of Mr. Ross A. Hull, Editor of *QST* Magazine.

On behalf of our club which is affiliated with your League, I wish to express our heartfelt sympathy, and would greatly appreciate it if you would be kind enough to convey same to the family of the late Mr. Hull.

—Les Amateurs Canadiens Francais de la T. S. F.
J. G. Drapeau, Sec'y

Brooklyn, N. Y.

The Radio Club of Brooklyn at its first Fall meeting held Friday, Sept. 23rd, instructed me to extend to you the sincere sympathy and condolence of each and every one of the membership.

The ranks of amateur radio operators and experimenters have lost a highly regarded compatriot and friend.

—Radio Club of Brooklyn
Carl E. Muldner, Sec'y

Vancouver, B. C.

It is with the deepest regret this association learns of the tragic death of our mutual friend and fellow amateur, Ross Hull.

In expressing our condolences to all who were his personal friends, we know we join thousands of world-wide "amateurs" in paying final respects to a gentleman, a genius and a friend, whose place in American Radio Relay League will be, not only difficult, but impossible to fill.

With deepest sympathy.

—The Point Grey Amateur Radio Club

Ballymoney, Co. Antrim, N. Ireland

The news of the sad death of Mr. Hull came to hand just before the date of our Annual General Meeting; and at that meeting I was instructed to convey to you the profound grief of the Radio Transmitters' Union of Northern Ireland at the loss of such a distinguished Radio Amateur and illustrious experimenter, together with our sincere sympathy with his relatives and with A.R.R.L. in their loss.

On behalf of R.T.U. (N.I.), I do this with all my heart.

—Radio Transmitters Union of N. Ireland
John L. Pinkerton, Hon. Sec'y

Roselle, N. J.

It was with great regret and sorrow that we learned of the death of Ross Hull. He was truly the amateur's friend and we are on common ground in the loss of a great man. He leaves us with the memory of a life's work well done.

—Union County Amateur Radio Ass'n, Inc.

Toronto, Ont., Canada

I have been requested by the Executive and Members of this Club to write you expressing our deep regret of the passing of Ross Hull. The announcement caused a hush to fall over our last meeting which expressed better than any words the loss suffered by his family and the A.R.R.L.

Please express our deepest sympathy to all concerned.

—Toronto Short Wave Club
Percy Berry, Sec'y

Victoria, B. C., Canada

We learn with deep regret of the sudden passing of Ross Hull, with whom we all felt in close touch, through his many articles in *QST*.

Permit me to extend to you the sincere sympathy of our members for the loss of a brilliant member of your staff.

—Victoria Short Wave Club
Henry R. Hough, Sec'y, pro tem.

Berlin-Dahlem, Germany

I just learned from Mr. Slawyk the bad news of the accidental electrocution of OM Ross Hull.

The D.A.S.D. with all its members wishes to express the deepest regrets to the passing of this most extraordinary amateur.

—Deutscher Amateur-Sende- u. Empfangs Dienst e.V.
H. Gebhardt, President

EDITOR'S NOTE.—Several hundred messages of sympathy concerning the death of Ross A. Hull have been received at the headquarters establishment from individual amateurs and members of the radio fraternity the world over. These are gratefully acknowledged on behalf of the Hull family and his friends and associates.

Visiting Ethics

Belleville, Kansas

Editor, *QST*:

Many articles have been written on the operation of ham rigs and the way a ham should conduct himself on the air. Even the ham's code tells of how a ham should conduct himself at school, work, home and other places. But how many books tell us how to act when visiting some other ham whom we have known on the air? . . .

After building up a friendship with another ham in some distant part of the country, perhaps we get a chance to meet him personally. Upon arriving at his home, we drop in on him unexpectedly. Of course he is delighted, and greets us with all the warm friendship and hospitality that it is possible for one friend to hold for another. Being interested in precisely the same thing, we both head for the shack where he proudly exhibits the apparatus that has made our friendship possible.

Now, whether you realize it or not, right then is when you will either form a lasting friendship or—not. No doubt you will want to keep him for a friend, so here is an example to follow. . . .

It stands to reason that the ham is fond of his equipment even if the transmitter is old and antiquated, and he should be. If he weren't just a little bit that way about his equipment, would he be a true ham? No. . . .

The visiting ham should, on entering the shack, let the host do the talking while the guest listens. Doubtless the host will have plenty to say about his rig, so remain quiet and attentive until he has finished before starting on a tour of inspection.

When he has shown you the more "elaborate" details, it is usually safe to start the inspection tour. But whatever you do, don't act as if you own the rig. By that I mean don't throw every switch you come across to see what will happen.

(Continued on page 64)

Wire Gauge P.A.S.	Turns per inch
10	6
12	7 $\frac{1}{2}$
14	9
16	12
18	15
20	19
22	24
24	30
26	38
28	48
30	60

A COIL is the one thing that about every amateur makes sooner or later. He may buy almost everything else that he needs ready-made, but if he does any experimenting at all he will have to wind a coil some day. Most likely he will have to wind a lot of coils. Such being the case, we are going to make a few observations on coils and resonant circuits this month. None of it will be new, and much of it will be rule of thumb, but we think it will be useful.

First of all, make the coil as large as you conveniently can, for large coils have higher Q than small ones. This applies particularly to the coil diameter. When the coil is inside a shield, the latter should clear the coil everywhere by a distance at least equal to the coil radius. Such a shield will reduce the inductance not more than 10 or 15 per cent, and will reduce the Q even less.

The length of the coil is not particularly critical. The statement is often made in handbooks that the ratio of diameter to length should be 2.46 to 1, because this ratio gives the highest inductance for a given length of wire. However, the *coil diameter* is usually the limiting dimension in practical cases. For a given coil diameter, the Q increases rapidly as the length is increased up to the point where the length is about equal to the diameter. Beyond this point the improvement is less marked.

A number of experiments have been made to determine the best wire size. Various investigators do not agree exactly, but it is pretty well established that the spacing between the turns should be slightly less than the diameter of the wire. The table above gives wire sizes in relation to turns per inch, and comes very close to giving the optimum values.

All of the above applies to single layer coils (solenoids).

Recently there has been a growing trend away from crystals in favor of stable master oscillators for controlling transmitter frequency. This is very convenient for shifting frequency, and is FB if it is carefully designed and operated. For any such purpose as this, the oscillator *must* be stable. We often hear the statement made that it is not necessary to design oscillator tank circuits for high Q , the idea being that it does not make any difference how many watts are used provided that the tube can supply them. This is not the whole story, for stability depends largely on the circuit Q .

Without going into the matter too deeply, it can be said that all losses (and load) on the oscillatory circuit should be kept at a minimum if constant frequency is the goal. This is why electron-coupled oscillators and MOPA systems are used for stability, — they remove the load from the oscillatory circuit. It is why grid current should be low. It is why plate resistance should be high.

Of course, the calibration of an oscillator is affected by such things as temperature, ageing, interelectrode capacity in the tube, etc. These effects are of a mechanical nature, and can be minimized by good mechanical design. The main point we want to make, however, is that frequency is also affected by plate voltage, filament voltage and the like. *The amount it is affected by them is inversely proportional to the circuit Q .* So use the best coil and condenser you can get.

JAMES MILLEN



Rugged! Dependable! Conservatively Rated!

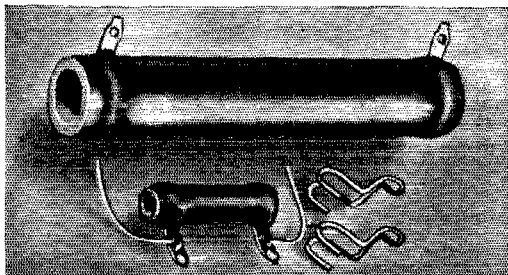

P. R. MALLORY & CO. Inc.

MALLORY

Vitreous and Variohm RESISTORS

Mallory Fixed Vitreous Resistors, type HJ, provide a standard unit for all transmitter, amplifier, and industrial applications. The small-sized resistors 1HJ (10-watt) and 2HJ (20-watt) are furnished with pig tails and lugs for mounting or connection. The larger resistors 5HJ (50-watt), 10HJ (100-watt), and 20HJ (200-watt) have connecting lugs only, and are supplied with convenient mounting brackets. Mallory Vitreous Enamelled Resistors can be depended on to provide long, uninterrupted service.

Mallory Variohm Adjustable Resistors, type AV, incorporate all the quality features of the Mallory HJ type of fixed resistors. Because of their adjustable feature these resistors are valuable for use in radio transmitter power supplies and general experimental work.

The adjustable clip supplied with each resistor is specially designed for ease of adjustment, and to prevent injury to the resistance wire while providing proper electrical contact. Additional clips are available. Two convenient mounting brackets are supplied with each variohm resistor.

P. R. MALLORY & CO., Inc.
INDIANAPOLIS INDIANA

Cable Address—PELMALLO

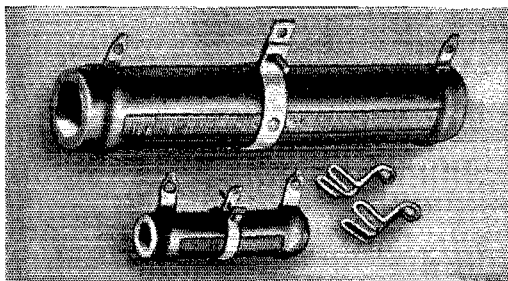

Use

P. R. MALLORY & CO. Inc.

MALLORY
APPROVED RADIO
PRECISION PRODUCTS

Use

YAXLEY
APPROVED RADIO
PRECISION PRODUCTS

Correspondence Dept.

(Continued from page 58)

Don't wiggle every tube, turn the dials or in short get everything out of whack. It seems to be every visiting ham's ambition to click the telegraph key and turn on the receiver.

Another serious thing . . . is the tendency of the older and more experienced ham who has higher power, better facilities, etc. to lord it over his lesser friend. Usually he does this unconsciously, but the other ham is sure to notice it, as he naturally feels smaller in the presence of one he admires. This is where the guest who is supposedly more important or more established in the ham world should move carefully if he wants many more pleasant QSO's. He should set about to make his host feel at home . . . make him feel that his homemade rig is just as good or better than one's own. This can be accomplished by praising the features of the rig that seem to be original and yet benefit the operator in some way. There is no need of flattery; simply emphasize the better points. . . .

If you see something that you do not approve of and would like to give him some instructions for improvement, that can be arranged, too. For example, you see a plate switch on the rig. It is nothing more than a d.p.s.t. light switch. The switch is sticking out at a convenient place on the rig but has high voltage going thru it and could very easily be "tangled" with. Rather than tell your host that you don't like it and then ask for some tape to fix it up with, you might ask him had he ever been "bit" by it. No doubt he will have a humorous incident to tell concerning it. You can then tell him how you have yours fixed, give its good points, and feel safe in suggesting a way to eliminate the danger.

When you have left, the ham will think to himself, "There is a real ham." He will like you and his respect will be doubled if you have conducted yourself right. . . . You did not take charge of his shack and act as if you knew about all the apparatus that he had on the table, and you made him feel he was on the same level as you even if you had been high man in the DX contest, had W.A.S. and about forty or fifty countries to his eighteen states. If you respect his shack, he will admire yours. Otherwise, he will not admire but be jealous.

It is not for me to tell you how to act but rather to give you an example. Common sense will tell you how to act when you go to visit a fellow ham. If you use caution, common sense, and above all let him know that you respect him, you will give him something to respect in you. True friendship is not built on familiarity alone but rather on respect and admiration.

Try it sometime.

—Kern Chadwick, W9ZJA

Portable or Emergency Rig

(Continued from page 80)

volts on the plate, the current will run between 65 and 70 ma., loaded. Unloaded it drops down to 5 or 10 ma.

There is no reason why the unit should be set aside for emergency use only. It makes an excellent exciter unit, drive for the following stages being taken from the antenna leads. Using a plug on the end of the power-supply cable, the unit can be unplugged from the regular transmitter and put into operation with the emergency supply at very short notice. If 14-Mc. output from the unit is contemplated, it is advisable not to key the oscillator but some following stage, because the keying chirp becomes magnified and objectionable at this higher frequency.

The final amplifier is practically as efficient doubling as it is working straight through, and thus two bands can be worked with any crystal—the crystal frequency and the second harmonic. This permits a good range with the four crystals the set accommodates.

RAYTHEON *Presents* RK63

200 WATT PLATE
DISSIPATION

EASY TO DRIVE

TRI-PLANE
CONSTRUCTION

LOW
CAPACITIES

TANTALUM
PLATE

The RK63, a triode, was designed by Raytheon's engineers to meet definite amateur requirements as a power amplifier, oscillator or frequency multiplier.

The new tri-plane construction permits very low interelectrode capacities, thus making neutralization easier, avoiding parasitics, and *greatly improving high frequency operation.*

Its amplification factor of 37 makes it easy to drive and protects the tube in case of failure of excitation.

The tantalum plate and grid give it long, gas-free life even with high **\$2200** momentary overloads. Price

CLASS C OPERATION

Plate Volts 3000 volts	Filament Volts 5 volts
Plate Current 250 ma	Filament Current . 10 amps.
DC Grid Current . . . 45 ma	
Plate Dissipation . 200 watts	

Don't forget your copy of the "Hand-book of Amateur Uses." It is just the thing to help you improve that old rig or build a new one. Your jobber or the nearest Raytheon office has a copy for you. Price 50c.

RAYTHEON RK TRANSMITTING TUBES

NEWTON, MASS. • NEW YORK • CHICAGO • SAN FRANCISCO • ATLANTA

"WORLD'S LARGEST EXCLUSIVE RADIO TUBE MANUFACTURERS"

NEW F.C.C. Regulations FOR 5-METERS

EFFECTIVE December 1, 1938, F.C.C. rules 381 and 382 concerning the stability of signals and their freedom from spurious radiations, harmonics, overmodulation, etc. for frequencies below 30,000 kc. are broadened to include all amateur frequencies below 60,000 kc. Directly modulated oscillators, unstable signals, wobulation and over-modulation are no longer acceptable in the 5-meter band.

An assured method of obtaining proper transmitter stability is to use quartz crystals. The Bliley HF2 10-meter crystal unit, designed primarily for 5-meter work, affords economical frequency control. Because only one doubling operation is required, construction is simplified and parts cost is kept at a minimum. With this dependable unit, portable high stability 5-meter transmitters are just as practical as higher powered equipment for home use.

Your Bliley distributor will show you how to build an effective simplified 5-meter crystal controlled transmitter.

Type HF2 — 28.0 to 30.0 mc., drift 43 cycles/mc./°C. within 50 kc. of specified frequency, or choice from dealer's stock. . . . \$5.75

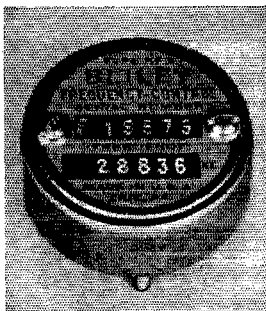

BLILEY HF2 10-METER CRYSTAL UNIT

Full-Range Selectivity with 455-Kc. Quartz Crystal Filters

(Continued from page 36)

Average impedance means the impedance throughout the narrow band of frequencies either side of resonance, where but slight attenuation is desired. Any intermediate degree of selectivity may therefore be secured merely by choosing the proper value of load impedance. By consulting the chart of impedance variations previously given, it is a simple matter to choose appropriate values for this impedance to meet the several degrees of selectivity desired. As the impedance of a parallel-tuned circuit (at resonance) is equal to the reactance multiplied by the Q , reducing either reactance or Q results in a decrease in impedance. The reactance of L and C_1 cannot conveniently be reduced (both would have to be reduced in order to maintain resonance), but the Q can be easily reduced to any desired value by simply inserting resistance in series with either the coil L or the condenser C_1 . Accordingly a tap switch S has been inserted between the low-potential end of L and ground. This switch has six positions marked "off," 1, 2, 3, 4 and 5. In the "off" position (extreme counter-clockwise) the crystal holder is short-circuited by means of two auxiliary contacts. In position No. 1 this short-circuit is removed and the crystal feeds into the parallel-tuned circuit LC_1 , which has previously been tuned precisely to the resonant frequency of the actual quartz crystal used. In this position of the switch, L and C_1 present their maximum possible impedance, as explained above in detail, and the crystal filter then provides the first step of increased selectivity over that obtainable from the tuned i.f. stages alone. In positions Nos. 2, 3, 4 and 5, successively greater amounts of resistance are introduced in series with L , resulting in smaller values of Q and lower load impedance into which the crystal works. Each increase in series resistance causes a corresponding increase in selectivity until position No. 5 is reached. This position provides the maximum selectivity of which the crystal is capable.

The preceding description and explanation, together with the curves showing the actual performance of this new crystal filter, prove conclusively that such a design does provide the complete range of selectivity required of communications receivers. The most important departure from previous designs is the rearrangement providing a sufficiently high-impedance load for the quartz crystal. The design and production of such a load circuit as an integral part of a practical filter is quite a problem in itself. To begin with, it must be very accurately tuned if it is to present maximum impedance to the crystal. By referring to the impedance figures previously listed, it will be noted that if mistuned only 3 kc. ($\frac{3}{8}$ per cent) its impedance is reduced to less than half its maximum. For this reason alone this circuit should be of the semi-permanently tuned type; that is, adjusted accurately during align-

Announcing...

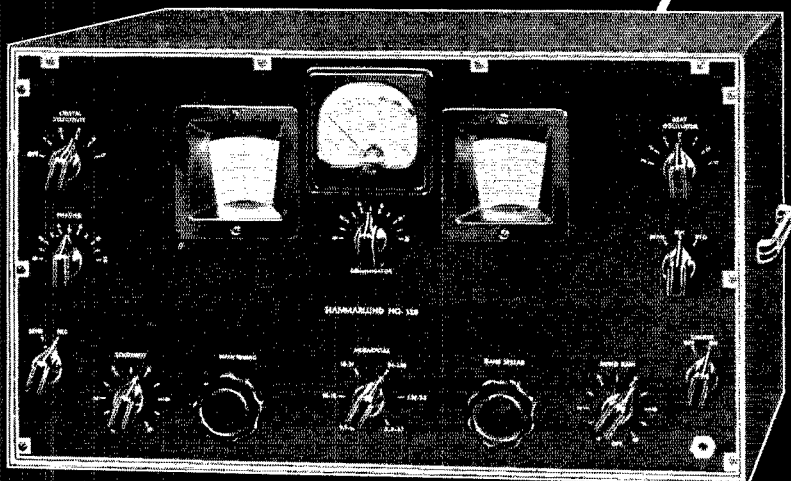

... THE NEW "HQ-120"

OUTSTANDING FEATURES

- Continuous range from 31 to .54 mc.—12 tubes.
- Antenna compensating control for maximum signal-to-noise ratio and image rejection.
- 310 degrees band-spread on all amateur bands.
- Noise limiter follows A.V.C. for quiet reception.
- Variable band width crystal filter for phone reception.
- Calibrated "S" meter on all models.

FROM INPUT to output terminals, this receiver is different. Conventionalities have been thrust aside and radically new ideas have been engineered into the new and remarkable "HQ-120" communications receiver. Special antenna compensating control on panel permits a wide selection of antennas and insures maximum sensitivity — New technique employed in the R.F. circuits provides uniform gain in each amateur band — Electrical band-spread and improved tuning control design result in 310 degrees spread. The dial is calibrated in megacycles from 80 to 10 meters inclusive. Calibration of the band spread dial is made possible by the extreme accuracy maintained in the tuning dial. The main tuning control is also calibrated in megacycles over the entire range of the receiver from 31 to .54 megacycles.

A new variable band-width crystal filter circuit is employed in the "HQ-120." A switch on the panel allows the selection of six different degrees of selectivity. The voltage-regulated power supply maintains a high degree of stability. Line voltage fluctuation will not affect the calibration of the receiver. The "HQ-120" also has a very effective noise limiter. This circuit is designed to faithfully follow the A.V.C. action and has no delicate panel control; a switch cuts it in or out.

Constant R.F. sensitivity, uniform crystal filter output coupled with a new and efficient meter circuit, provide accurate "S" meter readings and more worth-while signal reports. The "S" meter is calibrated in units up to "S-9" and also up to 40 db above "S-9". Other features are: beat oscillator; A.V.C.; stand-by switch; phone jack; relay connection; beautiful etched panel.

Write Dept. Q-12 for 16-page booklet



HAMMARLUND MFG. CO., INC.
424-438 WEST 33rd ST., NEW YORK

CANADIAN OFFICE: 41 WEST AVE., NO., HAMILTON, ONT.



New CARDWELL BAND-SPREAD TRIM-AIRS

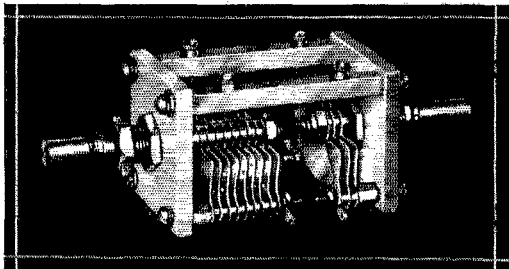

Peculiarly apropos for Heterodyne Frequency Meters in connection with new F.C.C. Regulations, Section 152.44, effective December 1st, 1938.

Very important to observe that whether Xtal controlled or not, you now need a device for "measurement of Xmt. frequency by means independent of the frequency control of the transmitter . . ."

Build your frequency meter around a Cardwell Band-Spread Trim-Air and be safe!

Type	Tuning Capacity	Tank Capacity	Depth Behind Panel	List Price	Amateur Net Price
EU-25-100-AF	25	100 mmfd.	2 3/4"	\$3.00	\$1.80
EU-50-100-AF	50	100 mmfd.	3 3/8"	3.25	1.95

THANK A MILLION

For your letters from all parts of the world thanking us for the Cardwell Multi-band condensers FEX and XE-160-70-XQ.

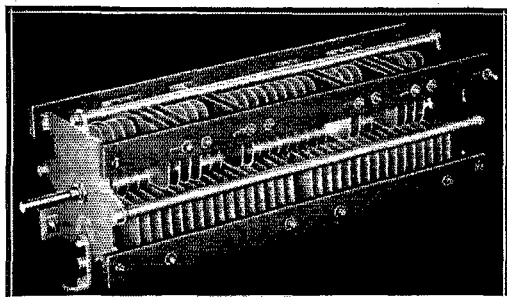

FEX is a FOUR-IN-ONE condenser. Four split stator ranges of effective capacity as shown.
 5-18.5 mmfd.
 7-35 mmfd.
 10-50 mmfd.
 19-120 mmfd.
 Amateur Net \$15.00

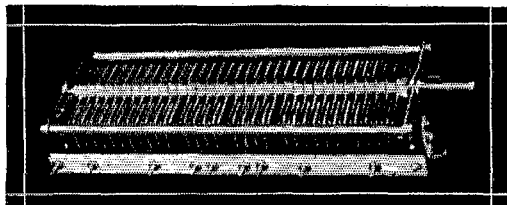

XE-160-70-XQ is a THREE-IN-ONE condenser. Three effective split stator ranges as shown.
 9-34 mmfd.
 13.5-83 mmfd.
 19-114 mmfd.
 Amateur Net \$13.20

Send for data sheet No. 10 on Push Button Tuned Tank circuits, using Cardwell Multi-band condensers and two pages of additional dope on suggested methods of mounting plug-in coils and jack base on the Multi-band units.

**THE ALLEN D. CARDWELL
MANUFACTURING CORPORATION**
83 PROSPECT STREET, BROOKLYN, NEW YORK

ment, rather than by a panel control that would have to be adjusted during the stress and strain of actual operating. For the same general reason it is felt that six accurately adjusted and definite degrees of selectivity, each instantly available by the flick of a switch, would prove highly desirable from the practical operating standpoint, although it has undoubtedly occurred to most readers that a continuously variable resistor could be used in place of R_1 , R_2 , R_3 , and R_4 . After being accurately tuned, this most important load circuit must remain in exact resonance during the varying conditions of actual operating. Since the grid of the second i.f. amplifier tube is directly across the circuit, certain precautions should be taken to prevent variations of the tube input capacity when the receivers, sensitivity control (either manual or a.v.c.) is altered. Otherwise optimum crystal filter performance will be obtained only at that setting of the gain control where the original tuning adjustment was made. The phasing control presents a similar problem, which was solved by the use of the double-stator condenser previously described. Since the capacity between its rotor and both stators remains constant, variations in its setting have no effect whatever on the tuning of the crystal load circuit.

The phasing control works very symmetrically in this new filter circuit. Its action is absolutely independent of the setting of the selectivity switch—another important advantage to the practical operator. When set to the center of its scale the crystal holder capacity is exactly neutralized, and the selectivity characteristics of the filter are truly symmetrical regardless of the position of the selectivity switch. When turned either side of center the familiar rejection dip is introduced in the filter response curve, above or below resonance depending on whether the control is turned above or below center scale. These rejection settings are equally independent of the position of the selectivity switch. For example, if the phasing control is set for rejection of a 1000-cycle beat note from an interfering transmitter, the degree of selectivity of the crystal can be altered at will with no effect whatever on the frequency of rejection, although the rejection dip in the response curve of the filter is deeper at the more selective settings of the selectivity switch.

PERFORMANCE DATA

By far the best conclusion to any description and discussion such as the foregoing is a complete set of data showing the actual performance of the device. One very interesting characteristic of this new filter is the extremely slight variation in output throughout the six steps of selectivity. This was investigated by means of constant c.w. input to the receiver, the output being recorded by a microammeter in series with the load resistance of the diode second detector. The sensitivity control was adjusted to produce a reading of 100 on the microammeter with the selectivity switch in the "off" position (crystal out), after tuning the receiver accurately to the signal with the selectivity switch on position No. 5. Readings were

CENTRALAB Ceramic Capacitor

HEAVY COPPER COATINGS MAKE
TUBULAR CAPACITOR PLATES

CERAMIC DIELECTRIC
FOR LOW POWER FACTOR.
COMPOSITION ALLOWS
COMPLETE CONTROL OF
CAPACITANCE-TEMPERATURE
COEFFICIENT

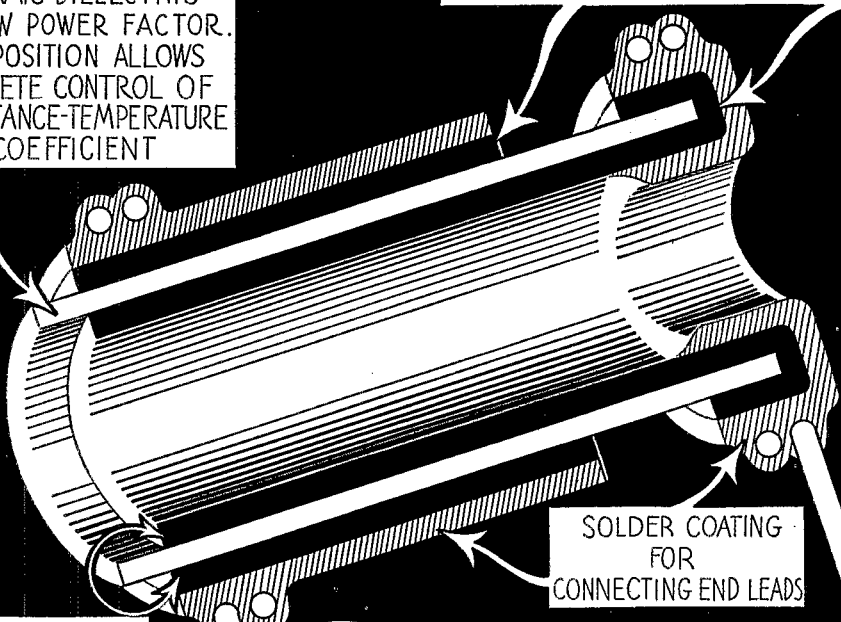

SOLDER COATING
FOR
CONNECTING END LEADS

ADEQUATE PROTECTION
AGAINST BREAKDOWN
AT 1000Volts

CROSS
SECTION
OF A
CERAMIC
CAPACITOR

We repeat "by popular demand"

THE interest in this new and unique member of the Centralab family prompts a "re-run" of this advertisement.

Thousands of these capacitors are already in use in the current automatic tuning receivers . . . and are delivering satisfactory and trouble-free performance.

For automatic tuning . . . negative temperature coefficient . . . to stabilize oscillator frequency in automatic tuning systems . . . also available with zero temperature coefficient where capacity values must stay constant over wide temperature range.

● A single capacitor will provide any desired capacitance-temperature coefficient from 0 to a negative coefficient of .0007 mmfd. per mmfd. per degree C.

● Ceramic dielectric has zero porosity. Capacity and power factor unaffected by aging or humidity.

● Low mass allows capacitor temperature to follow the chassis temperature closely.

● Capacitance remains constant at any frequency.

● Low power factor resin coating prevents moisture bridging between capacitor plates.

Engineers and Set Designers: Write for Engineering Bulletin Form 630.

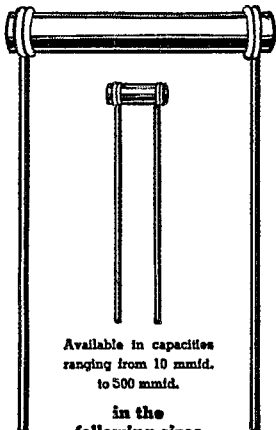

Available in capacitances
ranging from 10 mmfd.
to 500 mmfd.

in the
following sizes
Type 816— $\frac{1}{4}$ x $1\frac{1}{4}$ inch
Type 814 — $\frac{1}{4}$ x 1 inch
Type 810— $\frac{1}{4}$ x $\frac{3}{4}$ inch
Type 813— $\frac{1}{4}$ x $\frac{3}{4}$ inch

Centralab

Division of GLOBE-UNION INC., Milwaukee

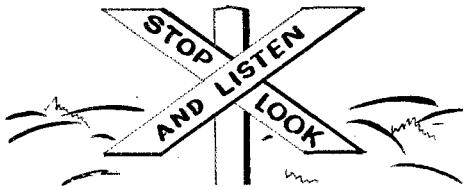

STOP "Beating around the bush" and bring your station up to date with a new Harvey 100-T transmitter. Don't compromise with make-shift changes and costly additions. Make yours a profitable investment with a transmitter which is modern, has a high trade-in value, and guarantees performance and satisfaction.

LOOK at the cabinet—modern from every angle—rounded corners, chrome trim and gray wrinkle finish. Best of all, the cabinet is only 19 inches high by 14 inches deep.

LISTEN to its signal on the air and you'll agree that the 100-T delivers the goods. The reason—Harvey engineering backed by five competitive years in the radio transmission field.

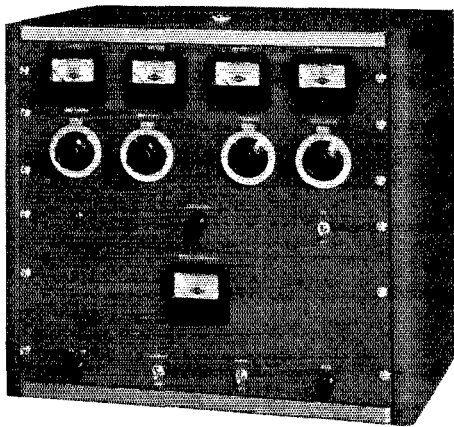

For Time Payments on the 100-T write to Henry Radio Shop, Butler, Missouri; Delaware Radio Sales Co., Wilmington, Delaware, or your local dealer. Our latest catalogue is ready if you'll write to Harvey Radio Laboratories, Inc., 25 Thorndike Street, Cambridge, Massachusetts.

then taken at all six positions of the switch. There was no drop on positions Nos. 1 and 2, and the drop on position No. 3 was negligible. On No. 4 the reading was 96 and on No. 5 it dropped to 86. This is only slightly more than 1 db variation in output throughout the entire selectivity range, and constitutes a further operating advantage, inasmuch as carrier-strength meter readings will be practically independent of crystal filter selectivity; actually the total variation amounts to about one-fifth of an "S²" unit.

Fig. 2 shows the selectivity characteristics of the crystal filter unit alone, with the curve of the tuned i.f. amplifier only shown in dashed lines, for comparison. It will be noted that the curve marked No. 1 (minimum crystal selectivity) is not quite as wide as predicted in the preceding analysis. Part of the discrepancy is due to the fact that the selectivity of transformer *T* was not taken into account in the calculation. In addition it is quite likely that some of the constants assumed for the crystal and its load circuit were slightly different in the actual filter unit measured. One significant fact is strikingly illustrated in Fig. 2. Quartz crystal filters can be built to give wide variations of selectivity for input ratios up to 10 or thereabouts, but several cascaded tuned circuits are needed to give the steep-sided selectivity curves at input ratios of 1000 and over. Naturally a combination of the two is ideal.

Fig. 3 shows the overall curves obtained from the entire i.f. amplifier for each of the six positions of the selectivity switch. These curves, as well as those of Fig. 2, were made with the phasing control set at neutral, in which position the crystal-holder capacity is exactly neutralized. Although the curves of Figs. 2 and 3 appear almost too smooth and symmetrical, they were nevertheless drawn from accurate measurements. The method of measurement itself was so precise that errors usually arising from that source were practically non-existent. In addition the entire amplifier was aligned by the visual method using the two-image system on the oscillograph screen. No difficulty was experienced in making the two images coincide exactly, even with the crystal in circuit; hence the high degree of symmetry.

Fig. 4 shows the effect of setting the phasing control to reject an interfering carrier 1000 cycles below crystal resonance. The setting of the phasing control was made with the selectivity switch on position No. 5. After completing the selectivity run, the selectivity switch was set on No. 1 and observations for the second curve were immediately made without disturbing the setting of the phasing control. It will be noted that the rejection dip is about 20 db. deeper in the No. 5 position, although the frequency of rejection remains unchanged.

Fig. 5 shows three audio fidelity curves which are an interesting check on the selectivity curves. Curve A is the fidelity of the complete i.f. amplifier with the selectivity switch in the off position; that is, with the crystal short-circuited. Curve B is with the switch on position No. 1 and with the phasing control in neutral. Curve C is taken

Proven:

THESE ARE THE TUBES FOR CHAMPIONS

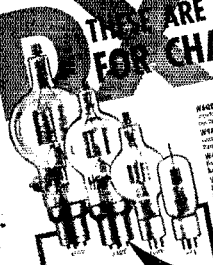

THIS WORLD'S MOST ADVANCED AMATEUR USE THESE BECAUSE:

1. Longest life span...
2. Superior tone...
3. Superior power...
4. Superior efficiency...
5. Superior economy...
6. Superior reliability...
7. Superior performance...

Eimac

McCULLOUGH, INC. • San Bruno, California

these ARE

THE TUBES FOR CHAMPIONS

OUR PREDICTION IN FEBRUARY 1938 ADV.

DX CONTEST RESULTS

CW winners:

1. Ralph E. Thomas W2UK
2. Fenton J. Priest, Jr. W3EMM
3. Clement M. Goo On W3EVT

PHONE winners:

1. Fenton J. Priest, Jr. W3EMM
2. Robert Hecksher W4CYU
3. Dave Evans W4DHZ
(operating "Doc" Stuart's W6GRL)

All of the above amateurs used Eimac Tubes.

The supreme accomplishment of amateur radio is to win the international DX contest. With ten's of thousands of contestants it takes more than mere luck to win. Thorough knowledge of the most advanced principles, expert operation and above all, keen judgement in the selection of equipment are the important factors.

It was not an accident that the winners of this DX contest came out victorious... neither was it an accident that Eimac tubes were used in the transmitters of the first three winners in both the phone and CW contests.

Amateurs who are confused in the selection of equipment will do well to follow the lead of these experts.

Eimac
TUBES

EITEL-McCULLOUGH, INC., San Bruno, California

IT TAKES MORE THAN CAPACITY

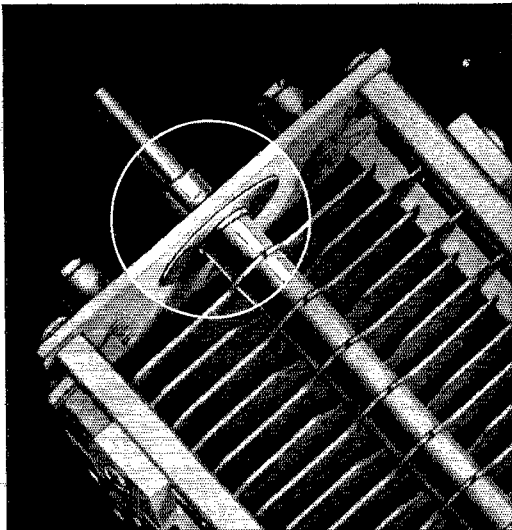

TO MAKE A GOOD CONDENSER...

HAMMARLUND'S new "TC" transmitting condenser is more than just a capacitor. Many outstanding and original features definitely put it in a class by itself. The special bearing emphasized in the illustration consists of a ground stainless steel shaft and bronze sleeve set in a Beryllium cushion disc. This special bearing construction assures absolutely smooth operation. The bearings are hand fitted.

Another feature is the non-magnetic rotor assembly. The shaft is firmly anchored in the end of the rotor but does not pass through it, thus providing all the advantages of a steel shaft without the disadvantages, in the form of losses at high frequencies, that would be encountered if the steel shaft was directly in the field of the condenser.

And, most important of all these premium condensers are sold at "regular" prices.

Send for "39" catalog containing further details on the "TC."

HAMMARLUND MFG. CO., INC.
424-438 W. 33rd St., N. Y. C. Q-12-38

Please send me 1939 catalog



Name

Address

City State



HAMMARLUND

Canadian Office: 41 West Ave. No., Hamilton, Ont.

under the same conditions as B except that the phasing control has been set to provide a rejection dip at 1000 cycles below resonance. Curve C is therefore the audio fidelity curve of the i.f. end of the receiver when its selectivity is as shown in the No. 1 selectivity curve of Fig. 4. It is interesting to note the slight difference between curves B and C in view of the great difference in their corresponding selectivity curves as shown by Curve No. 1 of Fig. 3 and Curve No. 1 of Fig. 4.

Of course, many of these performance curves depend on the choice of resistors, R_1 , R_2 , R_3 and R_4 . Other values than those used will result in different band widths for Curves 2, 3 and 4. However, the resistance values actually chosen result in what is considered an ideal selectivity range for a communications receiver.

New Regulations

(Continued from page 16)

years a license as a professional radiotelegraph operator or have within that time been employed as a radiotelegraph operator in the service of the United States; and the examiner for the written test, if not the same individual, shall be a person of legal age.

Sec. 151.19. *Additional examination for holders of Class C privileges.* The Commission may require a licensee holding Class C privileges to appear at an examining point for a Class B examination. If such licensee fails to appear for examination when directed to do so, or fails to pass the supervisory examination, the license held will be canceled and the holder thereof will not be issued another license for the Class C privileges.

Whenever the holder of Class C amateur operator privileges changes his actual residence or station location to a point where he would not be eligible to apply for Class C privileges in the first instance, or whenever a new examining point is established in a region from which applicants were previously eligible for Class C privileges, such holders of Class C privileges shall within four months thereafter appear at an examining point and be examined for Class B privileges. The license will be canceled if such licensee fails to appear, or fails to pass the examination.

Sec. 151.20. *Examination abridgment.* An applicant for Class A privileges, who holds a license with Class B privileges, will be required to pass only the added examination element No. 4. (See Section 151.16.)

A holder of Class C privileges will not be accorded an abridged examination for either Class B or Class A privileges.

An applicant who has held a license for the class of privileges specified below, within five years prior to receipt of application, will be credited with examination elements as follows:

Class of license or privileges	Credits
Commercial extra first	Elements 1, 2 & 4
Radiotelegraph 1st, 2nd, or 3rd	Elements 1 & 2
Radiotelephone 1st or 2nd	Elements 2 & 4
Class A	Elements 2 & 4

No examination credit is given on account of license of Radiotelephone 3rd Class, nor for other class of license or privileges not above listed.

Sec. 151.21. *Examination procedure.* Applicants shall write examinations in longhand,—code tests and diagrams in ink or pencil, written tests in ink—except that applicants unable to do so because of physical disability may typewrite or dictate their examinations and, if unable to draw required diagrams, may make instead a detailed description essentially equivalent. The examiner shall certify the nature of the applicant's disability and, if the examination is dictated, the name and address of the person(s) taking and transcribing the applicant's dictation.

Sec. 151.22. *Grading.* Code tests are graded as passed or failed, separately for sending and receiving tests. A code test is failed unless free of omission or other error for a continuous period of at least one minute at required speed. Failure to pass the required code test will terminate the examination. (See Sec. 151.23.)

A passing grade of 75 per cent is required separately for Class B and Class A written examinations.

Sec. 151.23. *Eligibility for reexamination.* An applicant who fails examination for amateur privileges may not take



HOT POTATO . . .

OFTEN-TIMES we do something a certain way "just because Grandpop did." We use articles every day which are made about the same as they were in the "horse and buggy days." Then a new way is tried that is so simple and logical it's a wonder nobody ever thought of it before.

Take small Power Rheostats for instance — for years they have been made using a ceramic base to which the resistance wire is attached, usually with a vitreous cement. This makes a good substantial assembly but they do get hotter than Billy-be-damned (if you want to be exact, we would judge B.B.D. to be about 250 to 300 degrees C. temperature rise at the hottest spot for full load). Like a hot potato, high temperature is not necessarily harmful to the unit itself, but is fatal to one's fingers, transformers, oil-filled condensers, etc. which might be around close.

Our new job, dubbed PR-25, is conventional in size, but not in design. We kept in mind its basic function of dissipating heat.

The metals are, of course, the best heat conductors, and aluminum is one of the best of metals in this regard. So, the shell of our new job and the core on which the resistance wire is wound are both of aluminum.

This results in a hottest spot temperature rise of only 140 degrees C. when 25 watts is applied to the element. Most important — the full 25

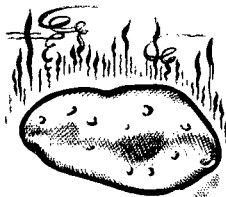

watts can be applied to as little as one-fourth of the winding with a rise of only 155 degrees C. Such treatment would severely overload the ceramic type.

The rest of the design, too, has been given customary care. The winding is insulated for 1000 volts to ground with electrical mica and specially treated asbestos. The terminals and shaft are insulated with ceramic. Current is carried direct to the rotor arm through a flat clockspring type connection — no sliding contact. The contact shoe is self-aligning and made of beryllium copper. Rotor contact pressure is furnished by a spiral steel spring separate from the current carrying spring. The unit is supplied complete with bakelite knob in all standard ranges from $\frac{1}{2}$ ohm to 5000 ohms.

We recommend it for filament control of the power stage in your transmitter. The filament voltmeter should be connected directly across the socket terminals so as to eliminate any error due to voltage drop in the filament leads. Operation of your power tubes at the correct filament voltage is extremely important.

This unit has three terminals, so it can also be used as a potentiometer voltage divider. It makes a really deluxe adjustment for bias voltage where the wattage is within 25 watts and where the voltage to ground does not exceed 1000 volts. The adjustment can then be made by a knob from the front panel with no danger of contacting high-voltage circuits.

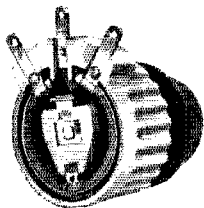

INTERNATIONAL RESISTANCE COMPANY • 401 NORTH BROAD STREET, PHILADELPHIA, PA.

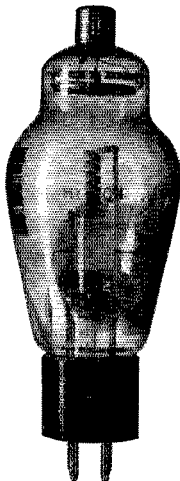

TYPE 866

Half-Wave, Mercury Vapor Rectifier

Filament Voltage (A.C.) 2.5 volts
 Filament Current, 5.0 amp.
 Max. RMS A.C. Volts 2650 max.
 Peak Inverse Voltage 7500 max.
 Peak Pl. Current .500 max. amp.
 Av. Pl. Current .250 max. amp.
 Tube Voltage Drop 15 volts

HEAVY DUTY

\$1.50 NET

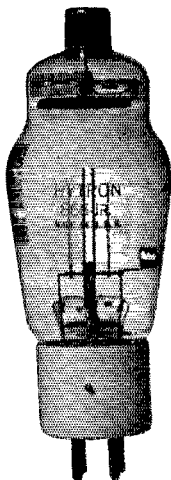

TYPE 866 JR.

Half-Wave, Mercury Vapor Rectifier

Filament Voltage (A.C.) 2.5 volts
 Filament Current . . . 3.0 amp.
 Max. RMS A.C. Volts 1250 max.
 Peak Inverse Voltage 1750 max.
 Peak Pl. Current .250 max. amp.
 Av. Pl. Current .125 max. amp.
 Tube Voltage Drop, 15 volts

CERAMIC BASE

\$1.05 NET

HYTRONIC LABORATORIES

76 Lafayette St.
 Salem, Massachusetts

A Division of Hytron Corp.

another examination for such privileges within two months, except that this rule shall not apply to an examination for Class B following one for Class C.

LICENSES

Sec. 152.01. *Eligibility for amateur station license.* License for an amateur station will be issued only to a licensed amateur operator who has made a satisfactory showing of control of proper transmitting apparatus and control of the premises upon which such apparatus is to be located; provided, however, that in the case of an amateur station of the military or Naval Reserve of the United States located in approved public quarters and established for training purposes, but not operated by the United States Government, a station license may be issued to a person in charge of such a station although not a licensed amateur operator.

Sec. 152.02. *Eligibility of corporations or organizations to hold license.* An amateur station license will not be issued to a school, company, corporation, association, or other organization; nor for their use; provided, however, that in the case of a bona fide amateur radio society a station license may be issued in accordance with Section 152.01 to a licensed amateur operator as trustee for such society.

Sec. 152.03. *Location of station.* An amateur radio station, and the control point thereof when remote control is authorized, shall not be located on premises controlled by an alien.

Sec. 152.04. *License period.* License for an amateur station will normally be for a period of three years from the date of issuance of a new, renewed, or modified license.

Sec. 152.05. *Authorized operation.* An amateur station license authorizes the operation of all transmitting apparatus used by the licensee at the location specified in the station license and in addition the operation of portable and portable-mobile stations at other locations under the same instrument of authorization.

Sec. 152.06. *Renewal of amateur station license.* An amateur station license may be renewed upon proper application and a showing that, within three months of receipt of the application by the Commission, the licensee thereof has lawfully operated such station in communication by radio with at least three other amateur stations licensed by the Commission, except that in the case of an application for renewal of station license issued for an amateur society or reserve group, the required operation may be by any licensed amateur operator. Upon failure to comply with the above requirements, a successor license will not be granted until two months after expiration of the old license.

Sec. 152.07. *Posting of station license.* The original of each station license or a facsimile thereof shall be posted by the licensee in a conspicuous place in the room in which the transmitter is located or kept in the personal possession of the operator on duty, except when such license has been filed with application for modification or renewal, or has been mutilated, lost, or destroyed, and application has been made for a duplicate.

CALL SIGNALS

Sec. 152.08. *Assignment of call letters.* Amateur station calls will be assigned in regular order and special requests will not be considered except that a call may be reassigned to the latest holder, or if not under license during the past five years to any previous holder, or to an amateur organization in memoriam to a deceased member and former holder, and particular calls may be temporarily assigned to stations connected with events of general public interest.

Sec. 152.09. *Call signals for member of U.S.N.R.* In the case of an amateur licensee whose station is licensed to a regularly commissioned or enlisted member of the United States Naval Reserve, the Commandant of the naval district in which such station is located may authorize in his discretion the use of the call-letter prefix N in lieu of the prefix W or K, assigned in the license issued by the Commission, provided that such N prefix shall be used only when operating in the frequency bands 1715-2000¹ kilocycles, 3500-4000 kilocycles, 50,000-60,000 kilocycles, and 400,000-401,000 kilocycles in accordance with instructions to be issued by the Navy Department.

Sec. 152.10. *Transmission of call signals.* An operator of an amateur station shall transmit its assigned call at the end of each transmission and at least once every ten minutes during transmission of more than ten minutes' duration; provided, however, that transmission of less than one minute duration from stations employing break-in operation need be identified only once every ten minutes of operation and at the termination of the correspondence. In addition, an operator of an amateur portable or portable-mobile radiotelegraph station shall transmit immediately after the call of the station the fraction-bar character (DN) followed by the number of the amateur call area in which the portable or portable-mobile amateur station is then operating, as for example:

Example 1. Portable or portable-mobile amateur station operating in the third amateur call area calls a fixed amateur station: W1ABC W1ABC W1ABC DE W2DEF DN3 W2DEF DN3 W2DEF DN3 AR.

¹Subject to change to "1,750 to 2,050" kilocycles in accordance with the "Inter-American Arrangement Covering Radio-communication," Havana, 1937.

There's a "HALL MARK"
on INSULATORS, too!



THERE'S a "Sterling" mark on silver—and the "Johnson" name on insulators—each with the same quality significance. And nowhere in your rig is quality and correct design more important.

Johnson insulators are made of highest quality, low-absorption ceramics, designed strictly according to modern engineering practice for best dielectric value, and mechanical strength.

Smooth glazed surfaces prevent the accumulation of dust, dirt and moisture and minimize leakage.

You can be sure, when you purchase a Johnson part, whether it's an insulator, condenser or any equipment that bears the Johnson name that you are getting top quality and modern engineering design.

Your rig will operate more efficiently with Johnson equipment.

E. F. JOHNSON CO.

WASECA, MINNESOTA

EXPORT: 25 WARREN ST., NEW YORK, N. Y.

"MANUFACTURERS OF RADIO TRANSMITTING EQUIPMENT"

This Multi-Range Tester is a "Natural" for every LABORATORY ENGINEER and AMATEUR



PRECISION Series 842-L

A.C.-D.C.-VOLT-OHM-DECIBEL
MILLIAMMETER-AMMETER

with 2500 Volt A.C.-D.C. RANGE and 1000 M.A. and 10-A.C. RANGES

Features of the Series 842-L

- * FIVE AC VOLTAGE RANGES at 1000 ohms per volt: 0-10; 0-50; 0-250; 0-1000; 0-2500 volts
- * FIVE DC VOLTAGE RANGES at 1000 ohms per volt: 0-10; 0-50; 0-250; 0-1000; 0-2500 volts.
- * SIX DC CURRENT RANGES: 0-1; 0-10; 0-50; 0-250 MA; 0-1/0-10 AMPS.
- * FOUR RESISTANCE RANGES: 0-400 ohms (20 ohms center) SHUNT METHOD. 0-100,000 ohms (800 ohms center). 0-1 Megohm (8000 ohms center). 0-10 Megohms (80,000 ohms center).

NOTE: Provisions for mounting ohmmeter power supply (4½ and 45v batteries) on inside of case. No external connections necessary.

- * FIVE DECIBEL RANGES FROM -10 TO +63DB: 0DB; +14DB; +28DB; +40DB; +48DB.
- * FIVE OUTPUT RANGES: 0-10; 0-50; 0-250; 0-1000; 0-2500 volts.
- * Large 4½ inch square D'Arsonval meter.
- * ACCURACY maintained with wire wound shunts and matched multipliers, both of 1% tolerance.

842-L Size 7½ x 8½ x 4. Housed in walnut finished wood case with carrying handle. **\$21.95**

842-P Same specifications as 842-L but housed in walnut finished wood portable case with removable cover. Size 9 x 10 x 6. Less Batteries and Test Leads. Net. **\$23.95**

AVAILABLE at LEADING DISTRIBUTORS

Following is a partial list

All branches.....	WHOLESALE RADIO SERVICE CO.
Belleville, Ill.....	LURTZ ELECTRIC CO.
Boston, Mass.....	THE RADIO SHACK
Chicago, Ill.....	CHICAGO RADIO APPARATUS
Columbia, S. C.....	DIXIE RADIO CO.
Denver, Col.....	INTER-STATE RADIO & SUPPLY CO.
Detroit, Mich.....	RADIO SPECIALTIES CO.
Hartford, Conn.....	HATRY & YOUNG INC.
Indianapolis, Ind.....	RADIO DISTRIBUTING CO.
Jamaica, L. I.....	PEERLESS RADIO DISTRIBUTORS
Los Angeles, Cal.....	KIERULFF & CO.
New York, N. Y.....	SUN RADIO CO.
Norfolk, Va.....	RADIO PARTS DISTRIBUTING CO.
Norfolk, Va.....	RADIO SUPPLY CO.
Portland, Ore.....	UNITED RADIO SUPPLY INC.
San Antonio, Texas.....	OLSEN RADIO SUPPLY
Seattle, Wash.....	NORTHERN RADIO CO.
South Bend, Ind.....	RADIO DISTRIBUTING CO.
Springfield, Mo.....	SPRINGFIELD RADIO CO.
Texarkana, Ark.....	MIMS RADIO CO.

PRECISION

APPARATUS COMPANY

821 EAST NEW YORK AVE., BROOKLYN, N. Y.
EXPORT DIVISION—458 BROADWAY, NEW YORK
Cable Address: "Morhanex"

Example 2. Fixed amateur station answers the portable or portable-mobile amateur station: W2DEF W2DEF W2DEF DE WIABC WIABC WIABC K.

Example 3. Portable or portable-mobile amateur station calls a portable or portable-mobile amateur station: W3GHI W3GHI W3GHI DE W4JKL DN4 W4JKL DN4 W4JKL DN4 AR.

If telephony is used, the call sign of the station shall be followed by an announcement of the amateur call area in which the portable or portable-mobile station is operating.

SEC. 152.11. *Requirements for portable and portable-mobile operation.* A licensee of an amateur station may operate portable amateur stations (Section 150.03) in accordance with the provisions of Sections 152.09, 152.10, 152.12 and 152.45. Such licensee may operate portable and portable-mobile amateur stations without regard to Section 152.12, but in compliance with Sections 152.09, 152.10, and 152.45, when such operation takes place on authorized amateur frequencies above 28,000 kilocycles.

SEC. 152.12. *Special provisions for portable stations.* Advance notice in writing shall be given by the licensee to the inspector in charge of the district in which such portable station is to be operated. Such notices shall be given prior to any operation contemplated, and shall state the station call, name of licensee, the date of proposed operation, and the locations as specifically as possible. An amateur station operating under this Section shall not be operated during any period exceeding one month without giving further notice to the inspector in charge of the radio-inspection district in which the station will be operated, nor more than four consecutive periods of one month at the same location. This Section does not apply to the operation of portable or portable-mobile amateur stations on frequencies above 28,000 kilocycles. (See Section 152.11.)

SEC. 152.13. *Special provisions for non-portable stations.* The provisions for portable stations shall not be applied to any non-portable station except that:

a. An amateur station that has been moved from one permanent location to another permanent location may be operated at the latter location in accordance with the provisions governing portable stations for a period not exceeding sixty days, but in no event beyond the expiration date of the license, provided an application for modification of license to change the permanent location has been made to the Commission.

b. The licensee of an amateur station who is temporarily residing at a location other than the licensed location for a period not exceeding four months may for such period operate his amateur station at his temporary address in accordance with the provisions governing portable stations.

USE OF AMATEUR STATIONS

SEC. 152.14. *Points of communication.* An amateur station shall communicate only with other amateur stations, except that in emergencies or for testing purposes it may be used also for communication with commercial or Government radio stations. In addition, amateur stations may communicate with any mobile radio station which is licensed by the Commission to communicate with amateur stations, and with stations of expeditions which may also be authorized to communicate with amateur stations. They may also make transmissions to points equipped only with receiving apparatus for the measurement of emissions, observation of transmission phenomena, radio control of remote objects, and similar purely experimental purposes.

SEC. 152.15. *No remuneration for use of station.* An amateur station shall not be used to transmit or receive messages for hire, nor for communication for material compensation, direct or indirect, paid or promised.

SEC. 152.16. *Broadcasting prohibited.* An amateur station shall not be used for broadcasting any form of entertainment, nor for the simultaneous retransmission by automatic means of programs or signals emanating from any class of station other than amateur.

SEC. 152.17. *Radiotelephone tests.* The transmission of music by an amateur station is forbidden. However, single audio-frequency tones may be transmitted by radiotelephony for test purposes of short duration in connection with the development of experimental radiotelephone equipment.

ALLOCATION OF FREQUENCIES

SEC. 152.25. *Frequencies for exclusive use of amateur stations.* The following bands of frequencies are allocated exclusively for use by amateur stations:

1,715 to 2,000 kc. ¹	28,000 to 30,000 kc.
3,500 to 4,000 kc.	56,000 to 60,000 kc.
7,000 to 7,300 kc.	112,000 to 118,000 kc. ²
14,000 to 14,400 kc.	224,000 to 230,000 kc. ²
	400,000 to 401,000 kc.

SEC. 152.26. *Use of frequencies above 300,000 kilocycles.* The licensee of an amateur station may, subject to change upon further order, operate amateur stations, with any type of emission authorized for amateur stations, on any fre-

¹ Subject to change to "1,750 to 2,050" kilocycles in accordance with the "Inter-American Arrangement Covering Radio-communication," Havana, 1937.

² The Commission reserves the right to change or cancel these frequencies without advance notice or hearing.

QST to every OM

HIGH

es YL de W2AFS
 in everything that
 makes a great
 capacitor except cost



TYPE TQ

DYKANOL TRANSMITTING CAPACITORS

are genuine Dykanol, FIREPROOF transmitting filter capacitors that can be mounted vertically or inverted by means of the mounting ring supplied. Equipped with neat porcelain terminals. Available in a complete range from 2 mike 600 to 2 mike 2000 v, at new low prices. Type TQ is specified in the new Thordarson 100 watt x-mitter. Be sure to send for new Catalog No. 161 today.

THAT'S the news about C-Ds. And it's news too big to hold. Cornell-Dubilier has combined *Super Performance* with *New Economy* to bring you a capacitor *HIGH* in quality, *HIGH* in efficiency, voltage and dielectric strength, yet down-to-earth in price. Take the shortest route to your jobber today. Ask for C-D — the capacitor with more abundant life at no extra cost.

Here are two of the popular amateur capacitors in the complete C-D line.

TYPE TJU

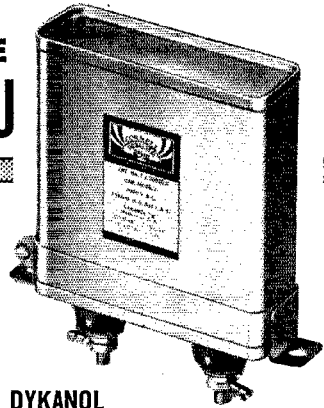

DYKANOL TRANSMITTING CAPACITORS

Type TJU Dykanol capacitors are among the most dependable units offered to the radio trade — amateur, broadcast and commercial. Beautifully designed, compact, light-weight, safety rated, furnished with universal mounting clamp, well-insulated terminals, fire-proof and attractively priced. Fully guaranteed. From half mike, 600 to 2 mike 5000 volts (and up to 25,000 v. d.c.).



CORNELL-DUBILIER ELECTRIC CORPORATION

1013 Hamilton Blvd., So. Plainfield, N. J.
 Cable Address: "CORDU"

New LICENSE MANUAL

incorporating

FCC
REGULATIONS

Effective
December 1st

NOW
Available

25 CENTS
POSTPAID
(No stamps please)

AMERICAN
RADIO RELAY LEAGUE
West Hartford, Connecticut

quency above 300,000 kilocycles without separate licenses therefor.

Sec. 152.27. *Frequency bands for telephony.* The following bands of frequencies are allocated for use by amateur stations using radiotelephony, type A-3 emission:

1,800 to 2,000 kc.	112,000 to 118,000 kc. ²
28,500 to 30,000 kc.	224,000 to 230,000 kc. ²
56,000 to 60,000 kc.	400,000 to 401,000 kc.

Sec. 152.28. *Additional bands for telephony.* An amateur station may use radiotelephony, type A-3 emission, in the following additional bands of frequencies; provided the station is licensed to a person who holds an amateur operator's license endorsed for Class A privileges, and actually is operated by an amateur operator holding Class A privileges:

3,900 to 4,000 kilocycles	14,150 to 14,250 kilocycles
---------------------------	-----------------------------

Sec. 152.29. *Television and frequency-modulation transmission.* The following bands of frequencies are allocated for use by amateur stations for television and radiotelephone frequency-modulation transmission:

112,000 to 118,000 kilocycles ²
224,000 to 230,000 kilocycles ²
400,000 to 401,000 kilocycles

Sec. 152.30. *Facsimile transmission.* The following bands of frequencies are allocated for use by amateur stations for facsimile transmission:

1,715 to 2,000 kc. ¹	112,000 to 118,000 kc. ²
56,000 to 60,000 kc.	224,000 to 230,000 kc. ²
	400,000 to 401,000 kc.

Sec. 152.31. *Individual frequency not specified.* Transmissions by an amateur station may be on any frequency within the bands above assigned. Sideband frequencies resulting from keying or modulating a transmitter shall be confined within the frequency band used.

Sec. 152.32. *Types of emission.* All bands of frequencies allocated to the amateur service may be used for radiotelegraphy, type A-1 emission. Type A-2 emission may be used in the following bands of frequencies only:

56,000 to 60,000 kc.	224,000 to 230,000 kc. ²
112,000 to 118,000 kc. ²	400,000 to 401,000 kc.

EQUIPMENT AND OPERATION

Sec. 152.40. *Maximum power input.* The licensee of an amateur station is authorized to use a maximum power input of 1 kilowatt to the plate circuit of the final amplifier stage of an oscillator-amplifier transmitter or to the plate circuit of an oscillator transmitter. An amateur transmitter operating with a power input exceeding nine-hundred watts to the plate circuit shall provide means for accurately measuring the plate power input to the vacuum tube, or tubes, supplying power to the antenna.

Sec. 152.41. *Power supply to transmitter.* The licensee of an amateur station using frequencies below 60,000 kilocycles shall use adequately filtered direct-current plate power supply for the transmitting equipment to minimize frequency modulation and to prevent the emission of broad signals.

Sec. 152.42. *Requirements for prevention of interference.* Spurious radiations from an amateur transmitter operating on a frequency below 60,000 kilocycles shall be reduced or eliminated in accordance with good engineering practice and shall not be of sufficient intensity to cause interference on receiving sets of modern design which are turned outside the frequency band of emission normally required for the type of emission employed. In the case of A-3 emission, the transmitter shall not be modulated in excess of its modulation capability to the extent that interfering spurious radiations occur, and in no case shall the emitted carrier be amplitude-modulated in excess of 100 per cent. Means shall be employed to insure that the transmitter is not modulated in excess of its modulation capability. A spurious radiation is any radiation from a transmitter which is outside the frequency band of emission normal for the type of transmission employed, including any component whose frequency is an integral multiple or submultiple of the carrier frequency (harmonics and subharmonics), spurious modulation products, key clicks, and other transient effects, and parasitic oscillations. The frequency of emission shall be as constant as the state of the art permits.

Sec. 152.43. *Modulation of carrier wave.* Except for brief tests or adjustments, an amateur radiotelephone station shall not emit a carrier wave unless modulated for the purpose of communication.

Sec. 152.44. *Frequency measurement and regular check.* The licensee of an amateur station shall provide for measurement of the transmitter frequency and establish procedure for checking it regularly. The measurement of the transmitter frequency shall be made by means independent of the frequency control of the transmitter and shall be of sufficient accuracy to assure operation within the frequency band used.

Sec. 152.45. *Logs.* Each licensee of an amateur station

¹ Subject to change to "1,750 to 2,050" kilocycles in accordance with the "Inter-American Arrangement Covering Radio-communication," Havana, 1937.

² The Commission reserves the right to change or cancel these frequencies without advance notice or hearing.

WHAT MORE CAN A COMMUNICATIONS JOB HAVE?

EVERY FEATURE amateurs have told us they want is incorporated in this 14-Tube TRAFFIC MASTER. Read them!

- 14 Octal-Base Tubes ● 530 KC to 32.4 MC (9.25 to 565 Meters) ● Better than 1 M.V. Sensitivity on all "Ham" Bands ● 5-Band Pre-Aligned Tuning Unit ● Electrical Band-Spread Condenser ● Band Setting and Band Spreading Controls ● Amateur Bands Located at Optimum Points on Various Ranges ● Large Full-Vision Dial, with 9" Linear Scales ● Separate Pointer on 0-100 Scale for Electrical Band Spread ● Flywheel Tuning on Both Main and Band-Spread Control ● 3-Gang Precision Tuning Condenser — Ceramic Insulated ● "Align-Aire" (Air-Tuned) Coils ● Fully Shielded Switch Assembly ● Mono-Unit Crystal-Filter Assembly with Phasing Control and Shorting Switch for Panel Operation ● Noise Silencer Circuit Built In ● Beat Frequency Oscillator with Panel Pitch-Control for CW Sigs — Air Tuned ● "R" Indication Meter; Carrier Level Indicator Calibrated 1 to 9 for Signal-Strength Reports ● Two Stages Ferrocart (Iron Core) I.F. Amplification ● "Align-Aire" (Air-Tuned) I.F. Transformers ● Full Automatic Volume Control, Maintains Constant Volume Level Under Severe Fading Conditions ● Doublet Antenna Connections ● Diode Second Detector ● Manual Volume Control ● Tone Control ● Headphone Jack ● Standby Switch ● 6C8G Phase Inverter, Resistance-Coupled to Output Stage ● Push-Pull 6V6 Output Class A ● 8.5 Watts Undistorted Power Output.

The TRAFFIC MASTER comes to you in COMPLETE KIT FORM — everything as illustrated except the tubes.

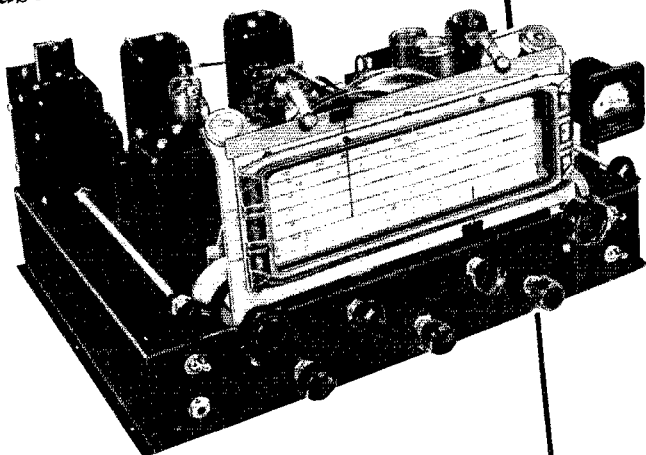

\$81.90

ASK YOUR PARTS JOBBER

New 120 PAGE INSTRUCTION BOOK

Packed full of invaluable information, both theory and technical data. With graphs and charts, pictorial diagrams, schematics, alignment data. Constructional data for 20 Meissner Kits.

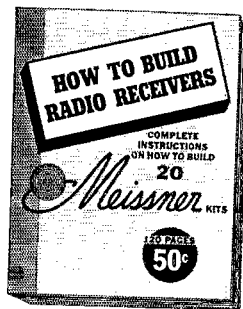

MT. CARMEL, ILLINOIS

"A FAMOUS NAME FOR TWO DECADES"

LOW-DRAIN BATTERY TUBES



an important
achievement

BRINGING new economy of space and operation to the battery radio field . . . Sylvania's recently-announced line of five low-drain tubes fills the needs of every amateur interested in battery radio sets.

These tubes are a complete complement for the design of any battery radio — ideal for that compact set which you've wanted to build. They give twice the normal battery life, with no C battery needed — and reception is free from line noise and A.C. hum.

Every amateur should have full information on these new tubes — so write today to the Hygrade Sylvania Corp., Emporium, Pa., for **FREE** technical data.

SYLVANIA

SET-TESTED RADIO TUBES

Also makers of Hygrade Lamp Bulbs

shall keep an accurate log of station operation, including the following data:

(a.) The date and time of each transmission. (The date need only be entered once for each day's operation. The expression "time of each transmission" means the time of making a call and need not be repeated during the sequence of communication which immediately follows; however, an entry shall be made in the log when "signing off" so as to show the period during which communication was carried on.)

(b.) The signature of the person manipulating the transmitting key of a radiotelegraph transmitter or the signature of the person operating a transmitter of any other type (type A-3 or A-4 emission) with statement as to type of emission, and the signature of any other person who transmits by voice over a radiotelephone transmitter (type A-5 emission). (The signature need only be entered once in the log provided the log contains a statement to the effect that all transmissions were made by the person named except where otherwise stated. The signature of any other person who operates the station shall be entered in the proper space for his transmissions.)

(c.) Call letters of the station called. (This entry need not be repeated for calls made to the same station during any sequence of communication, provided the time of "signing off" is given.)

(d.) The input power to the oscillator, or to the final amplifier stage where an oscillator-amplifier transmitter is employed. (This need be entered only once, provided the input power is not changed.)

(e.) The frequency band used. (This information need be entered only once in the log for all transmissions until there is a change in frequency to another amateur band.)

(f.) The location of a portable or portable-mobile station at the time of each transmission. (This need be entered only once provided the location of the station is not changed. However, suitable entry shall be made in the log upon changing location, showing the type of vehicle or mobile unit in which the station is operated and the approximate geographical location of the station at the time of operation.)

(g.) The message traffic handled. (If record communications are handled in regular message form, a copy of each message sent and received shall be entered in the log or retained on file for at least one year.)

The log shall be preserved for a period of at least one year following the last date of entry. The copies of record communications and station log, as required under this section, shall be available for inspection upon request by an authorized Government representative.

SPECIAL CONDITIONS

Sec. 152.50. Additional conditions to be observed by licensee. An amateur station license is granted subject to the conditions imposed in Sections 152.51 to 152.54 inclusive, in addition to any others that may be imposed during the term of the license. Any licensee receiving due notice requiring the station licensee to observe such conditions shall immediately act in conformity therewith.

Sec. 152.51. Quiet hours. In the event that the operation of an amateur station causes general interference to the reception of broadcast programs with receivers of modern design, such amateur station shall not operate during the hours from 8 o'clock P.M. to 10:30 P.M., local time, and on Sunday for the additional period from 10:30 A.M. until 1 P.M., local time, upon such frequency or frequencies as cause such interference.

Sec. 152.52. Second notice of same violation. In every case where an amateur station licensee is cited a second time within a year for the same violation under Section 152.25, 152.27, 152.28, 152.30, 152.31, 152.41, or 152.42, the Commission will direct that the station remain silent from 6 P.M. to 10:30 P.M., local time, until written notice has been received authorizing full-time operation. The licensee shall arrange for tests at other hours with at least two amateur stations within fifteen days of the date of notice, such tests to be made for the specific purpose of aiding the licensee in determining whether the emissions of his station are in accordance with the Commission's Regulations. The licensee shall report under oath to the Commission at the conclusion of the tests as to the observations reported by amateur licensees in relation to the reported violation. Such reports shall include a statement as to the corrective measures taken to insure compliance with the Regulations.

Sec. 152.53. Third notice of same violation. In every case where an amateur station licensee is cited the third time within a year for the same violation as indicated in Section 152.52, the Commission will direct that the station remain silent from 8 A.M. to 12 midnight, local time, except for the purpose of transmitting a prearranged test to be observed by a monitoring station of the Commission to be designated in each particular case. Upon completion of the test the station shall again remain silent during these hours until authorized by the Commission to resume full-time operation. The Commission will consider the results of the tests and the licensee's past record in determining the advisability of suspending the operator license and/or revoking the station license.

Sec. 152.54. Operation in emergencies. In the event of widespread emergency conditions affecting domestic communi-

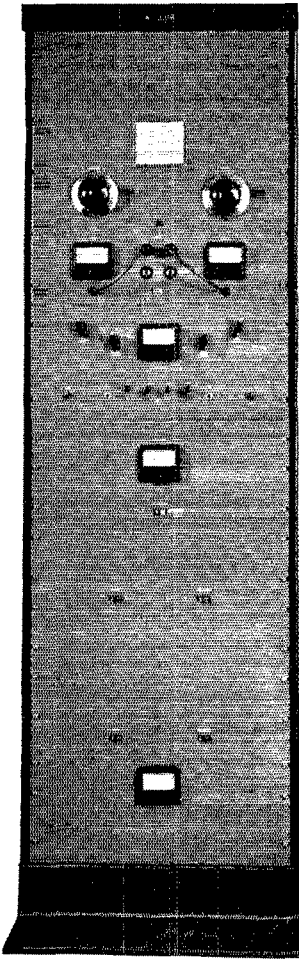

← Final Amplifier and Buffer →

← Exciter Unit and Speech Amplifier →

← Class B Modulators →

← Modulator and Buffer Power Supply →

← Final Power Supply →

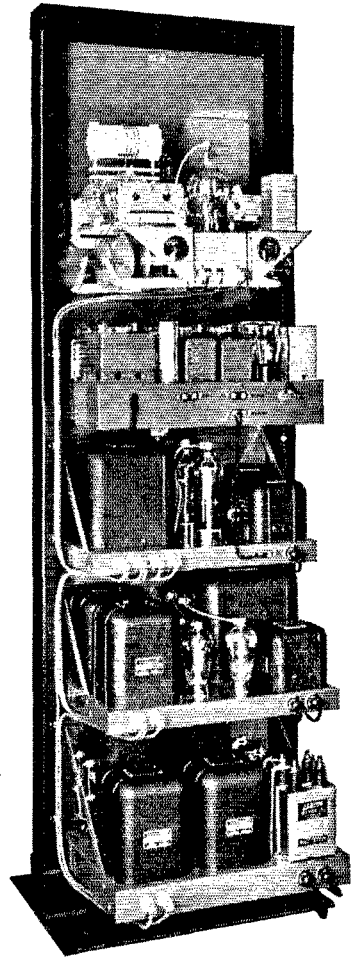

THE 600-WATT TRANSMITTER

The National 600-watt Transmitter is so thoroughly engineered that the newcomer can proceed with confidence, yet the units are so flexible that they allow the constructor almost complete freedom in building to suit his own particular requirements. The basis of the 600-watt Transmitter is the set of Foundation Units, panels and chassis completely finished and ready for assembly, supplied with the necessary special parts and hardware. The power supply and modulator chassis are punched to receive standard Thordarson CHT Units, combining convenience and reliability at low cost. More complete information on this efficient and economical transmitter will be found in the National "600-watt Transmitter" Booklet, newly revised, and in the National Catalogue, both available from your dealer.

NATIONAL CO., INC.

MALDEN, MASS.

Say You Saw It in *QST* — It Identifies You and Helps *QST*

Check your
R. F. Power
EASILY AND
ACCURATELY

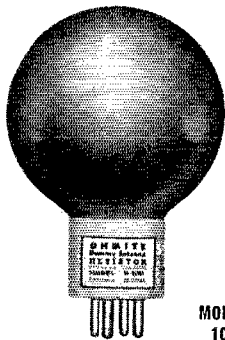

MODEL D-100
100 WATTS

PATENTS PENDING

Use the New OHMITE
Vacuum Type
DUMMY ANTENNA
Resistor

NOW—you have a simple, accurate way to check the R.F. power and output of your transmitter, tune it up to peak operating efficiency and avoid creating interference during tuning-up and adjustment. ★ The new Ohmite Model D-100 Dummy Antenna is built like a vacuum tube, with four-prong base. Mounts in standard tube socket. ★ Power easily determined from R.F. ammeter reading. ★ 73 ohm value — to match concentric and twisted pair lines. Available also in higher resistances. ★ 100 watt rating. Easily grouped for increased power capacity or other required resistances. ★ Unique non-inductive, non-capacitive design. List Price. \$5.50

Ask Your Jobber or Write Today for D-100 Data

OHMITE MANUFACTURING CO.
4831 W. Floumoy Ave. ★ Chicago, Illinois, U.S.A.

OHMITE
RHEOSTATS RESISTORS TAP SWITCHES

cation facilities, the Commission may confer with representatives of the amateur service and others and, if deemed advisable, will declare that a state of general communications emergency exists, designating the licensing area or areas concerned (in general not exceeding 1,000 miles from center of the affected area), whereupon it shall be incumbent upon each amateur station in such area or areas to observe the following restrictions for the duration of such emergency:

(a). No transmissions except those relating to relief work or other emergency service such as amateur nets can afford, shall be made within the 1715-2000¹ kilocycle or 3500-4000 kilocycle amateur bands. Incidental calling, testing, or working, including casual conversation or remarks not pertinent or necessary to constructive handling of the general situation shall be prohibited.

(b). The frequencies 1975-2000, 3500-3525, and 3975-4000 kilocycles shall be reserved for emergency calling channels, for initial calls from isolated stations or first calls concerning very important emergency relief matters or arrangements. All stations having occasion to use such channels shall, as quickly as possible, shift to other frequencies for carrying on their communications.

(c). A five-minute listening period for the first five minutes of each hour shall be observed for initial calls of major importance, both in the designated emergency calling channels and throughout the 1715-2000¹ and 3500-4000 kilocycle bands. Only stations isolated or engaged in handling official traffic of the highest priority may continue with transmissions in these listening periods, which must be accurately observed. No replies to calls or resumption of routine traffic shall be made in the five-minute listening period.

(d). The Commission may designate certain amateur stations to assist in promulgation of its emergency announcement, and for policing the 1715-2000¹ and 3500-4000 kilocycle bands and warning non-complying stations noted operating therein. The operators of these observing stations shall report fully the identity of any stations failing, after due notice, to comply with any section of this regulation. Such designated stations will act in an advisory capacity when able to provide information on emergency circuits. Their policing authority is limited to the transmission of information from responsible official sources, and full reports of non-compliance which may serve as a basis for investigation and action under Section 5102 of the Communications Act. Policing authority extends only to 1715-2000¹ and 3500-4000 kilocycle bands. Individual policing transmissions shall refer to this Section by number, shall specify the date of the Commission's declaration, the area and nature of the emergency, all briefly and concisely. Policing-observer stations shall not enter into discussions beyond essentials with the stations notified, or other stations.

(e). These special conditions imposed under this Section will cease to apply only after the Commission shall have declared such emergency to be terminated.

¹ Subject to change to "1750 to 2050" kilocycles in accordance with the "Inter-American Arrangement Covering Radio-communication." Havana, 1937.

A Practical Television Receiver

(Continued from page 25)

changed for different video carrier frequencies, because the sound i.f. signal is of fixed frequency, as in an ordinary superheterodyne receiver.

SYNC SEPARATOR

As has been previously mentioned, the output of the video amplifier includes the video signal and the two synchronizing signals. The function of the sync separator is to separate the high-amplitude horizontal and vertical synchronizing signals from the video signal. The sync separator employs a Type 6F8G twin triode (V_{10}). A small amount of signal from the video amplifier plate circuit is obtained from a resistance-capacitance voltage-divider network and amplified by triode unit "A" of V_{10} . Triode unit "A" also serves to reverse the polarity of the signal, so that the synchronizing pulses appear as large positive-peak voltages at the grid of the second triode unit, "B." Due to these high-amplitude positive peaks, triode "B" becomes partially blocked — the action being similar to that of a grid-leak detector under large-signal conditions. The grid-leak and grid-condenser values are selected so that triode



From Taylor Tubes

Sensational PRICE REDUCTION ON THESE TUBES

203A
 WAS \$12.50
NOW .. \$10⁰⁰
 OUR GIFT TO YOU \$2.50

211
 WAS \$12.50
NOW .. \$10⁰⁰
 OUR GIFT TO YOU \$2.50

204-A
 WAS \$90.00
NOW .. \$60⁰⁰
 OUR GIFT TO YOU \$30.00

Announcing
A NEW RECTIFIER
249-B

Filament 2.5 Volts 7.5 Amp.
 Peak inverse volts . . 10,000

The 249-B is a half-wave mercury vapor rectifier tube for 1KW to 3KW Transmitters. When used in a single phase full wave circuit with choke input, two 249-B's will deliver up to 1.25 amps at 3,300 volts. Has standard UX base and uses NONEX glass. Ceramic insulator under plate cap.

Each \$5

845
 WAS \$12.50
NOW .. \$10⁰⁰
 OUR GIFT TO YOU \$2.50

872A
 WAS \$12.50
NOW .. \$10⁵⁰
 OUR GIFT TO YOU \$2.00

T-55
 WAS \$7.00
NOW .. \$6⁰⁰
 OUR GIFT TO YOU \$1.00



Merry Christmas and a Happy New Year

FRANK HAJEK W9ECA

WARREN TAYLOR

BILL BISHOP W9UI

JOE HAJEK

REX MUNGER W9LIP



"More Watts Per Dollar"

TAYLOR TUBES, INC., 2341 WABANSIA AVE., CHICAGO, ILLINOIS

STUCK?

CANDLER'S Scientific Code System

Will Put You Over the "Hump"



WALTER H. CANDLER
Maker of Champions Will Train You Personally to Qualify for that Bigger, Better Job.

Don't be discouraged if you're stuck or have failed your code exam! Maybe you've spent hours in faithful practice — maybe you've tried again and again without progress — yet the *Candler System* can help you "over the hump" that seems to be your limit.

It's not how much you practice but how you practice that counts in learning code or gaining speed — and Candler can show you how.

Thousands of high speed radio ops — men like Chamblion Ted McElroy and other skilled amateur and commercial operators — can testify to the effectiveness of Candler System Code Training. It's different — you learn to read code by sound as you read print by sight. It's sure — Candler guarantees you whatever tickle you're working for, amateur or commercial. It's quick — the rapid progress of Candler students is amazing — in a few weeks time they accomplish what years of undirected practice failed to give them. It's easy — only a short time daily will suffice. And last but not least, it's inexpensive.

Don't be satisfied to be a "LID" when it's so easy to be a skilled operator. Let Candler train you the right way — the quick way. Ask any skilled operator about the *Candler System!* Who knows — it may be your start in a well-paid profession. Write today for the *Free Book of Facts* that tells you all about the Candler System.

COURSES for BEGINNERS and ADVANCED STUDENTS

Candler takes you right through from the very beginning to your amateur or commercial license. There's a course for beginners that teaches you all the necessary fundamentals scientifically — a course for operators who want to prepare themselves for the commercial radio field — and a Telegraph-Touch Typewriting course for those who want to become expert in the use of the typewriter, in receiving fast stuff. Remember, Candler trained operators are in demand for attractive commercial jobs. Send the coupon today for complete details.

CANDLER SYSTEM COMPANY

Dept. Q-12 Box 331 ASHEVILLE, NORTH CAROLINA

British Address: Room 56, Craven House, Kingsway London, W. C. 2

FREE — *Book of Facts*. Tells all about Candler Beginners' and Professional Training, records of Champions. All questions answered. No obligation.

MAIL THIS COUPON TODAY!

CANDLER SYSTEM CO., Box 331
Dept. Q-12, Asheville, North Carolina
Please send me *Free Book of Facts*.

Name.....

Address.....

City.....State.....

Code Speed (if any).....WPM

"B" conducts just for the duration of the synchronizing signals, and allows only these signals to appear as plate-current pulses in the output circuit. In this manner, the video signals are rejected and the two synchronizing signals are passed. The synchronizing signals are later separated from each other by the sync amplifiers, which are designated by the term "frequency separator" in the block diagram shown by Mr. Sherman in Part I.

A.G.C. AMPLIFIER

A Type 6F8G (V_{11}) is used for the automatic-gain-control stage. A small portion of the output of the video amplifier is applied to the grid of triode unit "A" of V_{11} . This signal, after amplification by triode "A," is applied to triode unit "B" connected as a diode. Triode "B" operates like a peak vacuum-tube voltmeter. That is, due to the relatively large time constant of resistor R_{51} and condenser C_{72} , the d.c. voltage developed across R_{51} is held near the peak value of the applied a.c. voltage. The peak a.c. voltage depends not only on the amplitude of the synchronizing signals, but also on the average amplitude of the video signals. The a.g.c. voltage developed across R_{51} is filtered in the usual manner and applied as negative grid bias to the r.f. and i.f. amplifiers.

The a.c.-coupled a.g.c. system employed in this receiver does not provide as effective gain control as a direct-coupled a.g.c. system. However, the latter arrangement involves additional complications in the power supply and other circuits.

POWER SUPPLY

The power supply includes a full-wave, high-vacuum rectifier (Type 5T4) and a conventional, low-resistance, two-section filter. A choke-input type of filter is used to provide good voltage regulation. The output of the filter is rather heavily loaded in order to keep the d.c. plate load of the 1852 video amplifier small. It is essential to minimize the voltage variations across R_{60} caused by fluctuations of d.c. load current with a.g.c. voltage. Front and back views of the supply, mounted on a 5¼ by 19-inch relay-rack panel, are shown in the photographs.

CONSTRUCTIONAL DETAILS

The various parts of the receiver are mounted on a standard panel of one-eighth inch sheet aluminum, 8¾ by 19 inches, designed for relay-rack mounting in a cabinet. Some details of the mounting of the different units which go to make up the complete television receiver can be seen in the photographs. The receiver chassis mounts vertically, at a distance (depending on the length of the kinescope) behind the front panel of the cabinet. Although these photographs show the receiver with the 9-inch kinescope, Type 1800, they will serve to illustrate the method of assembly, which is equally suitable for smaller cathode-ray tubes such as the 902 and 906. The scanning unit (third from bottom) is of the electromagnetic type, and is not the same as the electrostatic scanning unit described by Mr. J. B. Sherman.

Also shown are photographs giving front and

HIGH EFFICIENCY ON *All* BANDS

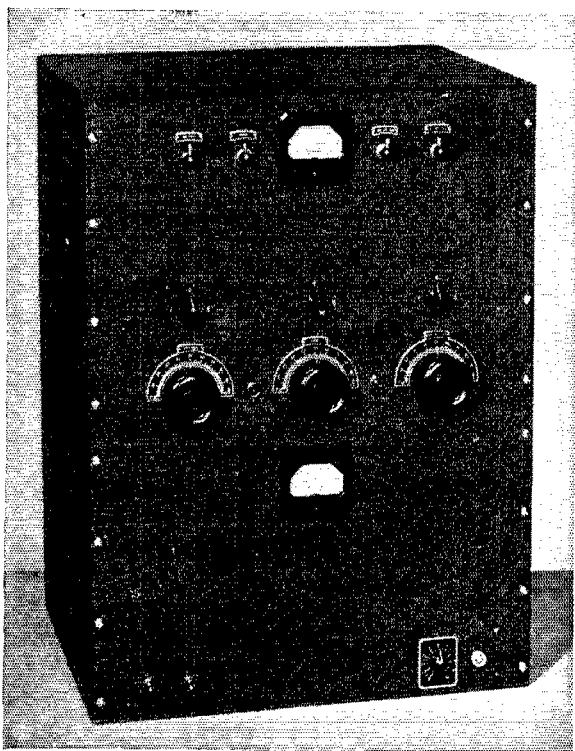

with
THORDARSON
"MULTI-BAND"
TRANSMITTER

●

ACTUAL MEASURED EFFICIENCY

10 METERS — 65%

20 METERS — 73%

Here is performance of the highest order: a transmitter with 100 watts input and outputs of 65 watts on 10 meters or 73 watts on 20 meters — by actual measurement. Even higher efficiencies are obtained on the other bands. Investigate the Thordarson 100 watt "Multi-Band" Transmitter. Let it prove itself!

*Free descriptive bulletin SD-378 just released—
see your parts distributor or write factory direct.*

THORDARSON ELECTRIC MFG. CO.

500 W. HURON ST., CHICAGO, ILL.

Demand "Power by Thordarson"

QST

YEARLY BINDERS



Are We Right?

You should have at least two of them — one for your complete 1938 file of copies, and one for each 1939 issue as published.

With each Binder is furnished a sheet of gold and black gummed labels for years 1922 through 1941. The proper one can be cut from the sheet and pasted in the space provided for it on the back of the binder.

Price **\$1.50** postpaid

Available only in United States and possessions, and Canada

THE AMERICAN RADIO RELAY LEAGUE
West Hartford, Conn.

back views of the receiver chassis with all parts mounted, but with the shield cans removed from units of differing construction. The front view shows the r.f. and oscillator-mixer units (in the shield cans) with the ganged, channel-changing switch mechanism at the tops of the cans. The two potentiometers located near the top of the chassis in the rear view are (right) the a.g.c. control (R_{42}) and (left) the Kinescope cathode-bias control (R_{55}). The latter serves to adjust the brilliance of the picture on the Kinescope screen.

In the back view of the receiver chassis the "hand-tailored" units from which the shield cans have been removed are as follows: bottom left, i.f. coupler No. 4; top left, video-amplifier input compensating unit; top center, video-amplifier output network; top right, i.f. coupler No. 1; and bottom right, sound-buffer input network. The lower shield can contains i.f. coupler No. 3; the upper shield can, i.f. coupler No. 2. The holes through which the variable condensers in an i.f. unit are tuned can be seen in the shield can at the lower right-hand corner.

Constructional details of the various coupling units, filter networks, and compensating networks, as well as a description of the alignment, adjustment, and operation of the television receiver, will be given in a subsequent issue.

(NOTE.—*In the design of this receiver, a great deal of care has been given to the selection of components, both electrically and from the standpoint of suitable physical size, and their placement. To aid the constructor, manufacturers' names have been given in each case where the choice of a component is important. A complete chassis layout will be given in the subsequent article.*—EDITOR.)

Bibliography

1. "Television," Vols. 1 and 2, *RCA Institutes Technical Press*, 75 Varick St., New York, N. Y.
2. Banson and Campbell, "Television," Section 15, *Electrical Engineers Handbook*, Pender and McIlwain.
3. Poch and Epstein, "Partial Suppression of One Side Band in Television Reception," *Proceedings of the I.R.E.*, Jan. 1937.
4. Seely and Kimball "Analysis and Design of Video Amplifiers," *RCA Review*, October, 1937.
5. Preisman "Some Notes on Video Amplifier Design," *RCA Review*, April, 1938.
6. R. D. Kell, A. V. Bedford, and M. A. Trainer, "Scanning Sequence and Repetition Rate of Television Images," *Proc. I.R.E.*, April, 1936.
7. R. S. Holmes, W. L. Carlson, and W. A. Tolson, "The Receivers," *Proc. I.R.E.*, Nov. 1934.
8. Freeman and Schantz, "Video Amplifier Design," *Electronics*, Aug. 1937.

Hamdom

(Continued from page 17)

very crude apparatus sending out CQ's and working DX right from the fortress—of all places!

It wasn't long before the government caught up with PJ3CO and relieved him of his transmitter and receiver. His standing as a private in the Dutch army is still as good as ever, but at this writing the officials have not as yet decided whether they will confiscate his gear and relieve him of his call letters.

Utah JUNIOR TRANSMITTER!

THE PERFECT BEGINNER'S RIG

CRYSTAL
CONTROLLED

25 WATT CW

OPERATES ON ALL
AMATEUR BANDS from
10 to 160 METERS

\$15.95

LESS TUBES,
METERS AND CRYSTALS



THE beginner in amateur radio will find this an easy rig to build and to operate, and a perfect transmitter with which to gain operating experience.

It is unquestionably a most economical transmitter for any amateur to build, enabling him to "get on the air" with the least possible expenditure for an efficient, versatile rig.

Although complete from power supply to antenna tuning circuit, parts have been held to a minimum and tuning procedure has been greatly simplified.

All the amateur bands from 10 to 160 meters can be worked, with suitable crystals, simply by changing a single coil for each band.

As in all Utah Transmitter Kits, quality has been maintained in all the parts — it's a rig any beginner will be proud to own and operate. See your UTAH Jobber or write direct for complete description and schematic diagram on this and other models.

Utah

UTAH RADIO PRODUCTS CO.
CABLE: UTARADIO, CHICAGO

"DEPENDABLE SINCE 1922"

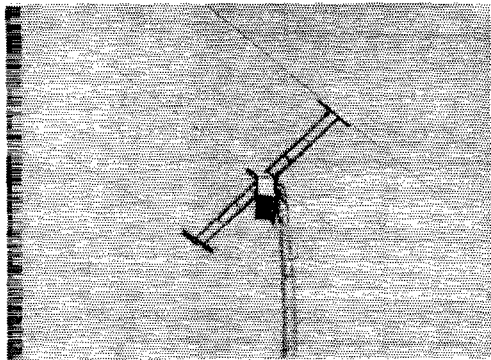

The New 3-Element General Rotary Beam Antenna

Gives an increase in forward gain over the 2-element General and with reduced QRM. No Tuning Necessary. Elements with correct lengths, and impedance match furnished for your frequency.

Complete 20m. Generals { 2-Element, \$38.80
Now as low as { 3-Element, \$54.60

Direction indicators, ohmmeter and synchronous motor types. Sets of elements only, arrays for your rotating head, motors, reducing gears, shock absorbers, control cable. Prices subject to change without notice. Shipments F.O.B. Factory — Ohio. Write for full information to

Sales Department

GENERAL ROTARY ANTENNA CO.

Coral Gables, Florida

"Eventually a GENERAL Rotary Beam"

NEW "PEE - WEE" INDUCTORS by Coto

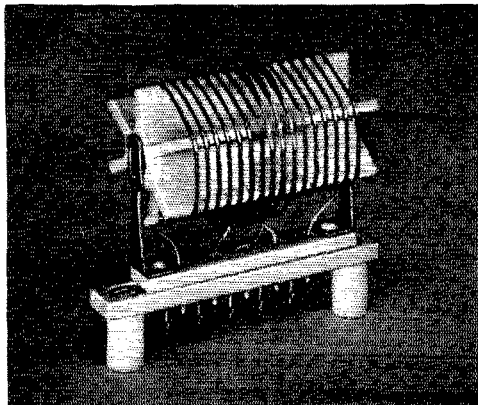

50 Watt capacity wound on threaded Alsinag No. 196 forms. Available for 10-160 meters with or without link — any type. Miniature plug-in base available for band-switch, condenser or chassis mounting. All type coils, \$1.90 List. Mounting base, \$.60 List.

COTO COIL CO., INC.
PROVIDENCE, R. I.

In view of this story I vowed I'd appeal to the American hams, through *QST*, to write to Holland and try to intercede for him. I'm no ham myself and I sincerely hope the radio amateurs are not thinking that an SWL is trying to butt in on their affairs.

Humphrey Arthur Crawford still has several years to serve as a soldier and traffic cop on the Island of Curacao, and unless he can return to his one and only hobby, it will seem like a lifetime to him. Am I "out of order," hams, and what's the answer? You have his full name. His address is Waterfort, Willemstad, Curacao, N. W. I.

—William D. Watkins

There is a sequel to this story. On October 24th PJSCO stood trial before a military court martial in Curacao. Although details of the outcome are not available at the time this issue of QST goes to press, a reliable source indicates that the maximum penalty of Fl. 1000 (about \$670) will not be imposed. Nevertheless, Mr. Watkins still urges all amateurs, not only in the United States but elsewhere, to write letters of intercession to the N.V.I.R., Post Box 400, Rotterdam, Netherlands, in his behalf. It is believed that, under the circumstances, such letters can be of great use to PJSCO.

How Much Spacing?

(Continued from page 39)

diminishes to almost none, and the circuit of Fig. 1-B then behaves as the circuit of Fig. 1-C. Of course, this does not justify the omission of the connection between the tuning condenser rotor and the positive plate supply terminal, because damage is done during the period of arcing; and in addition, a delay in attaining proper operating conditions is incurred.

With plate-modulated 'phone operation using the circuit of Fig. 1-B, even more trouble is caused in placing the circuit in operation. Before the blocking condenser is charged to the power supply voltage, an arc occurs which is likely to continue until the plate supply voltage is removed from the amplifier.

RESULTS OF TESTS

A study of the four diagrams in Fig. 2 shows the comparison between ratings of peak voltage per section for four circuit conditions with split-stator tuning condensers. The diagrams show the maximum peak voltages across a single condenser section for a push-pull transmitter of 1250-volt plate supply, with 100-per cent plate modulation applied for the diagrams of Fig. 2-B and -D. The upper diagrams apply to a section of the tuning condenser connected as in A or B of Fig. 1, while the lower ones show corresponding voltages existing across each section of the condenser with the connections of Fig. 1-C. It will be noted that in the latter, the maximum peak voltages are less than half those of the upper diagrams, with the result that the condenser spacing may be much less than half that required for the arrangements of Fig. 1-A or -B.

Actual tests bear out the above statements.

The Season's Greetings from Newark Electric

Plan NOW to have a new receiver for Christmas.

No matter what set you want, or whether your budget says "splurge" or "go easy," NEWARK has just the receiver for YOU at the price you want to pay. You can buy ON EASY TERMS if your order totals \$60 or more, sets and parts. A small down payment will deliver your receiver promptly . . . and you can take up to one full year to pay the balance.

\$2950 COMPLETE

Only CASH That's all you pay for **HALLICRAFTER SKY BUDDY, MODEL S-19.** Every Ham can afford a new receiver when even the leading makes are priced so low. No time payments. \$29.50 is all you pay, now or ever!

\$4950 YOUR CHOICE

Only CASH NATIONAL'S NEW NC 44 or HALLICRAFTER SKY CHAMPION Model S-20 can be yours complete at this low price! Take your choice. Both are wonderful values. Send \$10 with order and we'll ship C. O. D. for balance. Or select \$10.50 worth of parts and supplies from our catalog and buy on easy payments.

\$2250 DOWN \$2300 DOWN \$2450 DOWN

NATIONAL NC 100 x A (Cash Price \$142.50) complete with tubes, crystal and speaker in cabinet, for only \$22.50 down and monthly payments of \$21.10 for 6 months, \$14.21 for 9 months, or \$10.80 for 12 months.

HALLICRAFTER SUPER SKY RIDER SX 16, complete with tubes, crystal and speaker. Pay only \$23.00 down and \$17.74 monthly for 6 months, \$11.93 for 9 months or \$9.02 for 12 months. Cash Price \$123.00.

\$2788 DOWN \$2860 DOWN \$2970 DOWN

RME 69 complete with tubes, crystal and speaker. Down payment only \$27.88. Then pay \$21.94 per month for 6 months, \$14.77 for 9 months, \$11.25 for 12 months. You'll like buying this easy way. (Cash Price \$152.88).

NEW RME-70 complete with tubes, crystal and speaker. Cash Price \$138.60. But you'll never miss a \$28.60 down payment and monthly installments of \$19.42 will pay you up in 6 months. Or pay \$13.07 for 9 months. Or \$9.91 for 12 months.

NATIONAL HRO DE LUKE complete with tubes, crystal and coils. \$29.70 down and \$26.14 monthly for 6 months, \$17.67 for 9 months or \$13.45 for 12 months. (Cash Price \$179.70.) Power Supply \$15.90 extra. Speaker Mounted in cabinet to match . . . \$14.10 extra.

\$3300 DOWN \$3450 DOWN \$4100 DOWN

HAMMARLUND SUPER-PRO complete with tubes and 8" Dynamic Speaker. Choice of Model SP 110, 15 — 560 meters OR Model SP 110S, 7.5 — 240 meters. Cash Price \$243.00. Pay only \$33 down and \$36.35 for 6 months, \$24.61 for 9 months, or \$18.75 for 12 months.

HALLICRAFTER SUPER SKY RIDER SX-17 complete with tubes, crystal and speaker. Priced at \$149.50 cash but you need only pay \$34.50 down! Then \$20.26 monthly for 6 months, \$13.64 for 9 months or \$10.36 for 12 months.

HAMMARLUND SUPER PRO complete with tubes, crystal and 8" Dynamic Speaker.

Buy Now and Pick your Price!

NATIONAL—HALLICRAFTER—RME HAMMARLUND and RCA AMATEUR COMMUNICATION RECEIVERS

\$29⁵⁰ to \$261⁰⁰

YOURS for only \$24 DOWN

NC 101X



NATIONAL'S famous NC 101X complete with tubes, crystal and speaker. Cash Price \$129.00. Terms are \$18.88 monthly for 6 months, \$12.50 for 9 months or \$9.47 per month. Pay at \$9.47 per month.

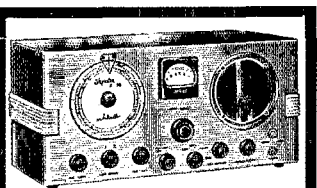

PAY ONLY \$1950 DOWN HALLICRAFTER SKY RIDER 5-10

Complete with tubes and speaker, the cash price is \$69.50. But with a small down payment as above, you can take 9 months to pay the balance at \$6.26 per month. Or pay \$9.32 monthly for 6 months. Order direct from this ad.

AT \$1450 OR \$1900 DOWN

\$14.50 down buys the **HALLICRAFTER SKY RIDER MARINE** complete with tubes and speaker. Then you pay \$9.32 monthly for 6 months or \$6.26 for 9 months. Cash Price \$64.50.

For \$19.00 down you can pick either **NATIONAL'S NC 80X, NC 81X** (complete with tubes, crystal and 8" PM speaker in cabinet) or **HALLICRAFTER'S SKY CHALLENGER II** complete with tubes, crystal, and speaker. Monthly payments are \$14.36 for 6 months, \$9.66 for 9 months, or \$7.30 for 12 months. Either set priced at \$99.00 Cash.

Your Call Letters in Gold

Hams look at this! Your Call letters in impressive three dimensional style. Big shadowed decalomania letters nearly TWO INCHES high. Put them on your HAM SHACK door, auto window, etc. Send dime for yours today. Be sure to give your call letters.

FREE CATALOG

Illustrations, prices and full details on thousands of separate items, sets, tubes, parts and supplies! **MAKE UP A \$60 ORDER** and Buy All the supplies you need at present low prices. **AND PAY ON EASY TERMS.** Write for this Big 76-page Catalog Today.

NEWARK Electric Company

323 W. MADISON ST. CHICAGO, ILL. Dept. Q



E. H. Rietsche
Pres. CREI

"Another Man" is waiting for Your Job!

CREI training insures your future

● The Radio Industry is crammed with "pretty good" men . . . that's why your boss can afford to be "choosy" in selecting men for better jobs. He knows that there is always *another man waiting for your job* . . . but, DO YOU? Right now is the time to insure your future in Radio. You must be *technically trained to hold and improve your present position.*

GOOD men have the GOOD JOBS!

Modern improvements demand men with advanced technical training who can step into the new jobs that are constantly being created. There's always room at the top for men who can produce. Our story is vital to your future and the success of every Radioman — *send for it today.*

TEAR OUT COUPON AND MAIL FOR FREE BOOK

FREE! Please send me your new illustrated book, "A Tested Plan for a Future in Radio"

Name.....

Address.....

City.....



Capitol Radio Engineering Institute
Dept. Q12, 3224 16th St., N.W., Washington, D. C.

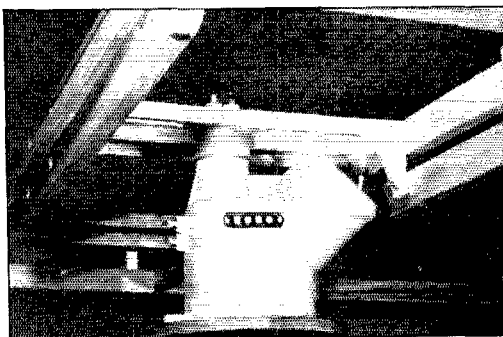

AMPLEX

Introduces a new rotary antenna unit built to meet the requirement of the most exacting operator. The powerful compact mechanism is encased in an aluminum alloy housing which affords complete protection from weather. All working parts are bathed in oil. A new antenna feeding arrangement permits continuous rotation with any type of feeder or matching system. The speed of rotation is $\frac{3}{4}$ of 1 r.p.m. The synchronized direction indicator timer is an integral part of the gear reduction and is so designed the indicator clock can be connected at any time. The weight of the main unit is 17 lbs. The supporting framework is made of cypress.

AMPLEX ENGINEERING CO.
New Castle, Indiana

One specific instance taken was an 808 series-fed single-tube amplifier with split-stator plate circuit to provide for neutralizing. For proper 100-per cent plate-modulated 'phone operation with this stage, with 1250 volts at 100 ma. (125 watts input), the proper tuning capacity per section was found to be 1.1 $\mu\text{fd.}$ per meter wavelength.² Using this value with the chart of Fig. 4, the watts-input ratio was found to be 114, and the r.f. voltage per condenser section was found to be approximately 680 without modulation, or 1360 with 100-per cent plate modulation.

From these figures, an unusually small spacing for the tuning condenser, 0.05 inch, was indicated, since this spacing, intermediate between the receiving condenser spacing of 0.03 inch and the old "double spacing" of 0.07 inch, is rated at 1500 volts. A condenser of 180- $\mu\text{fd.}$ maximum capacity per section (Cardwell MO-180-BD) and 0.05-inch spacing was obtained for the 808 amplifier. With the amplifier loaded to 100 ma. plate current at 1250 volts, provided with adequate excitation for linear 100-per cent modulation, and fully modulated, no arcing occurred while the condenser was connected as in Fig. 1-C, but 100-per cent modulation could not even be closely approached with the circuit of Fig. 1-B before arcing stopped the transmitter.

Corresponding tests were conducted with the condenser as in Fig. 1-B in a 2500-volt amplifier with telegraphy operation. Arcs were maintained throughout the first dots of keying until the blocking condenser became charged nearly to the supply voltage, after which proper operation ensued for a time. With the rotor of the tuning condenser connected directly to the positive high-voltage terminal as in Fig. 1-C no arcs resulted.

The comparison in Fig. 2 between the telegraph and modulated peak voltages across each section of a split-stator condenser in the circuit of Fig. 1-B and the corresponding peak voltages of Fig. 1-C clearly shows the importance of the d.c.-shorting circuit between the rotor and stator sections of the condenser, for a 50-per cent reduction of the required peak voltage rating of the condenser usually results in a reduction greater than 50 per cent in required plate spacing, and an accompanying reduction in the total condenser plate area, so that a much more economical and compact condenser may be used.

OTHER TUNING CONDENSER CIRCUITS

In Fig. 5 are shown six r.f. amplifier plate circuits in which no supply voltage appears across the tuning condenser (or tuning condenser section). Calculations for the required spacing of these condensers are based on the r.f. voltage alone, and thus may be taken directly from the chart of Fig. 4, as may the spacing of a split-stator condenser connected in any of the circuits of Fig. 3.

It is important in the three circuits of the top row in Fig. 5 that the condenser rotors have the dependable, safe insulation from the tuning control recommended above for the condensers of Fig. 1-B and -C.

² Reinartz, "How Much C P", QST, March, 1937.

THE AMATEUR'S BOOKSHELF

A balanced selection of good technical books, additional to the A.R.R.L. publications, should be on every amateur's bookshelf. We have arranged, for the convenience of our readers, to handle through the A.R.R.L. Book Department those works which we believe to be most useful. Make your selection from the following, add to it from time to time and acquire the habit of study for improvement. *Prices quoted include postage.* Please remit with order.

RADIO THEORY AND ENGINEERING

FUNDAMENTALS OF RADIO, *Second Edition*, by R. R. Ramsey. A modernized revision of the author's work which has been a favorite with amateurs and experimenters since 1929. 426 pages, 439 illustrations. 2nd Edition, 1935.....\$3.50

RADIO ENGINEERING, by F. E. Terman. A comprehensive treatment covering all phases of radio communication. An all around book for students and engineers, 811 pp., 474 illustrations. 2nd Edition, 1937.....\$5.50

ELEMENTS OF RADIO COMMUNICATION, by Prof. J. H. Morecroft. This is the 2nd edition of this book by the author of the well-known "Principles." It is about half the size of the larger work, and the subject is treated in more elementary fashion. Simple algebra is sufficient. An excellent book for the "first-year" student. 279 pp. 170 illustrations, 1934.....\$3.00

PRINCIPLES OF RADIO, by Keith Henney. This book is chock-full of meat for the experimenter. The subjects treated range from the fundamentals of electricity to the modern concepts of modulation and detection. 477 pp., 306 illustrations. 2nd Edition, 1934.....\$3.50

COMMUNICATION ENGINEERING, by W. L. Eorritt. A general text for both first year and advanced courses. Complete treatment of network theory, including mathematical analysis of radio circuits and tube operation. 727 pp., 411 illustrations. 2nd Edition, 1937.....\$5.00

PRINCIPLES OF RADIO ENGINEERING, by R. S. Glasgow. Mathematical presentation of the fundamentals of radio communication and their application. A large portion of the book is devoted to the theory and use of the vacuum tube in communication systems. 520 pp., 6 x 9. 1936.....\$4.00

FUNDAMENTALS OF VACUUM TUBES, by Austin V. Eastman. Treats the laws underlying operation of the principal types of tubes — high-vacuum, mercury-vapor, photo and special tubes — with engineering analysis of their more important applications. 438 pages, 6 x 9. 1937.....\$4.00

FUNDAMENTALS OF RADIO, by F. E. Terman. An elementary version of the author's "Radio Engineering," with simplified treatment and intended for readers of limited mathematical ability. Suitable as a text for an introductory course in radio, and features problems for class-room work. 458 pages, 278 illustrations, 1938.....\$3.75

ELECTRON OPTICS IN TELEVISION, by I. G. Naloff and D. W. Ebsitt. Covers the theory of electron optics and practical design problems in constructing cathode-ray tubes for television work. An introductory section outlines the principles of cathode-ray television. 299 pages, 197 illustrations, 1938.....\$3.50

ELECTRICAL ENGINEERS' HANDBOOK, VOL. V. ELECTRIC COMMUNICATION AND ELECTRONICS, edited by H. Pender and K. McIlwain. A comprehensive handbook covering the field of communication, both wire and radio, and electronics. 1022 pages, 3rd edition, 1936.....\$5.00

RADIO EXPERIMENTS AND MEASUREMENTS

MEASUREMENTS IN RADIO ENGINEERING, by F. E. Terman. A comprehensive engineering discussion of the measurement problems encountered in engineering practice, with emphasis on basic principles rather than on methods in detail. 400 pages, including an appendix of outlines for laboratory experiments and a comprehensive index. 210 illustrations, 1935.....\$4.00

THE CATHODE-RAY TUBE AT WORK, by John F. Rider. Devoted to cathode-ray tube theory, sweep circuits, A.C. wave patterns and description of commercial oscilloscope units including actual photographs of screen patterns representing about every condition likely to be encountered in audio- and radio-frequency amplifiers, power supplies, complete receivers and transmitters. 322 pages, 444 illustrations.....\$2.50

HIGH-FREQUENCY MEASUREMENTS, by August Hund. A thorough, modern book, especially useful in advanced laboratory work. Includes a chapter on piezo-electric determinations. 491 pp., 373 illustrations, 1935.....\$5.00

EXPERIMENTAL RADIO ENGINEERING, by Prof. J. H. Morecroft. An excellent laboratory text directed specifically to emphasizing the principles involved in the operation of radio apparatus and intended as a companion to the same author's "Principles." Following an introductory chapter on instruments and accessories, 51 choice experiments are outlined. 345 pp., 250 illustrations, 1931.....\$3.50

EXPERIMENTAL RADIO, by Prof. R. R. Ramsey. Fourth Edition. A splendid book for the experimenter. This is a laboratory manual, describing 132 excellent experiments designed to bring out the principles of radio theory, instruments and measurements. 167 illustrations, 196 pp., 5 1/4 x 7. 1937.....\$2.75

RADIO FREQUENCY ELECTRICAL MEASUREMENTS, by Hugh A. Brown. A laboratory course in r.f. measurements for communications students. Contains much practical information on methods of measurement. 384 pages, 177 illustrations, 1938.....\$4.00

COMMERCIAL EQUIPMENT AND OPERATING

PRACTICAL RADIO COMMUNICATION, by A. R. Nilson and J. L. Hornung. A new modern treatment meeting the expanded scope of today's technical requirements in the various commercial fields. The first six chapters are devoted to principles, the remaining nine to latest practice in broadcasting, police system, aviation radio and marine communication. 754 pages, including an appendix of tabulated data and a complete topical index. 434 illustrations, 1935.....\$5.00

THE RADIO MANUAL, by George E. Sterling. Another excellent practical handbook, especially valuable to the commercial and broadcast operator, and covering the principles, methods and apparatus of all phases of radio activity. Over 900 pp., 1938.....\$6.00

RADIO TRAFFIC MANUAL AND OPERATING REGULATIONS, by Duncan and Drew. A book for students, amateurs or radio operators who contemplate entering the commercial field; it will enable you to learn quickly and easily all the government and commercial traffic rules and operating regulations. 181 pp.....\$2.00

RADIO OPERATING QUESTIONS AND ANSWERS, by Nilson and Hornung. A companion volume to "Practical Radio Telegraphy" by the same authors. The latest Revised Edition is very complete, covering Commercial and Broadcasting, Amateur, Aeronautical and Police Radio, Beacons, Airways, Meteorology, and Teletype Operating. 389 pp. 5 1/4 x 8. 1936.....\$2.50

HOW TO PASS RADIO LICENSE EXAMINATIONS, by Charles H. Drew. Question and answer material on various types of commercial operator examinations. The commercial equivalent of the A.R.R.L. License Manual. 201 pages, 73 illustrations, 1938.....\$2.00

RADIO OPERATOR'S MANUAL, by the Radio Dept., G. E. Co. Primarily a manual to qualify an applicant for the radiotelephone classes of license (including police), but also provides material of general interest to users of commercial radio equipment. 181 pages, 56 illustrations, 1938.....\$1.00

MISCELLANEOUS

THE RADIO AMATEUR CALL BOOK. Lists all U. S. and foreign amateur radio stations, s.w. commercial and broadcaster. \$1.25 (Foreign \$1.35)

MAKING A LIVING IN RADIO, by Zeh Bouck. 222 pages, 25 illustrations. A worth-while book for the radio amateur who is considering entering the Commercial Radio field in its many branches; explodes the bunk, points out the pitfalls.....\$2.00

RADIO DATA CHARTS, by R. T. Beatty. A series of graphic charts for solving, without the use of mathematics, most of the problems involved in receiver design. 82 pp., 8 1/4 x 11.....\$1.50

SERVICING RECEIVERS BY MEANS OF RESISTANCE MEASUREMENTS, by J. F. Rider. 203 pp., 94 illustrations. An excellent book for the service man and amateur constructor.....\$1.00

SERVICING SUPERHETERODYNES, by John F. Rider. Theory and practice of superheterodynes, with adjustment and trouble-shooting data. 278 pages, 94 illustrations.....\$1.00

The following books published by the American Radio Relay League, *The Radio Amateur's Handbook, The License Manual, Hints & Kinks, How to Become a Radio Amateur, 200 Meters and Down, Building an Amateur Radiotelephone Transmitter*, and of course *QST*, comprise the foundation of every Amateur library.

AMERICAN RADIO RELAY LEAGUE, INC., WEST HARTFORD, CONNECTICUT

Cannot be
Acoustically
Overloaded

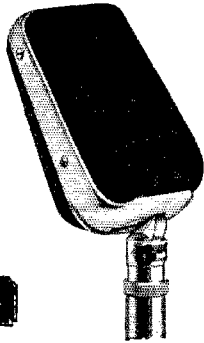

ASTATIC

**New MULTI-UNIT Series
CRYSTAL MICROPHONES**

Veteran amateurs, along with professional and commercial users, are praising the performance of this new creation of engineering skill. Dual diaphragm construction. Reduced feedback tendencies. Cannot be acoustically overloaded. Made in two models. Beautifully finished. Complete with interchangeable locking connector and 25-ft. cable.

MU-2 \$29.50 LIST PRICES MU-4 \$39.50

See Jobber or Write for Literature

*** ASTATIC ***

ASTATIC
Microphone Laboratory, Inc.
Youngstown, Ohio

Licensed Under Brush Development Co. Patents

"UNDER-PRICED"

● That tells it. These quality instruments are truly a Ham's dream come true. Picture your panel dressed up with instruments of the finest kind—instruments with the expensive bridge-type construction and soft iron pole pieces—but costing no more than you have formerly paid for the ordinary run of instruments.

Note the brief description below and write today for convincing details covering a wide range of types and ranges.

SIMPSON ELECTRIC CO., 5210 Kinzie St., Chicago

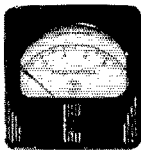

A typical value . . .

Bridge type instrument in handsome 3"x3 1/4" case with illuminated dial at a net price to amateurs in most A.C. and D.C. ranges of only. . . . **\$4.65**

Including 6-V. Built-in Lamp



Another . . .

The Simpson 3" bridge type Milliammeter at only. . . . **\$4.15**

SIMPSON Instruments that *STAY accurate*

I. A. R. U. News

(Continued from page 48)

I am sure, that if hams here were able to hear the jamming host of W signals on the DX bands in the South Pacific they would realize that to call a station there is like taking a ticket in a lottery. Even though their signal may be S9 they would wonder how they work through as easily as they do. There is no doubt that, except for local interference, the QRM problem is worse in N. Z. than in W, due to skip distance here in the U. S.

In this connection, the practice on the lower frequency bands of groups of stations working a "round table" on a spot frequency must do much to reduce annoying QRM.

I have found many amateurs in the U. S. imagine that they have much more difficulty in contacting a large total of countries than hams elsewhere, but listening on a receiver, especially on the east coast, more countries can be heard at any time than in New Zealand. Of course I realize that to hear a station is one thing and to work it another matter.

I have found the qualifications necessary to operate an amateur station less strict here. In N. Z., to become a ham one must pass a three-hour written examination in theory and law, and a practical test in operating at 13 w.p.m. This enables the successful candidate to operate c.w. and 'phone on 80 meters only. When an operator is able to prove 6 months' work on this band, another practical test may be attempted in which the station's note is checked and a code test of 20 w.p.m. passed. Passing the test enables the operator to work c.w. on any band and 'phone on 10 and 5 meters. Twenty-meter 'phone is allowed only between 12 midnight and 7 A.M. N.Z.S.T. in the American 'phone band and only with a special permit.

Traveling across the continent I have found a surprisingly strong loyalty to the League and unlimited hospitality to the visiting ham, with everything from conventions to traffic totals on a colossal scale. In conclusion, given the equipment and technical information of this country and the radio location of my country we would, it seems to me, have that Utopia of which every dyed-in-the-wool amateur dreams.

Field Day Results

(Continued from page 32)

3527, 7005, 7054 and 7117 kc. were used. Power was supplied from a 500-watt, 110-volt a.c. gas-driven generator, wound and built by W9LTC, and ran the whole 26 hours cold. The antenna really worked fine, being a half-wave, end fed zepp with 64 foot feeders, fastened between two trees, 50 feet above ground.—*The Austin Radio Club, W9LTC-9.*

Our location was a camp 6 miles southeast of Stover, Missouri, in the foothills of the Ozark Mountains where no commercial power is available.—*Sedalia Amateur's Radio Club, W9LVA-9.*

The Panther Valley Gang operated near Pottsville, Pa., on the farm of W8BLT. Six complete station units were on hand but some could not operate due to lack of sufficient a.c.

My Creed

To give you specialized personal service of genuine value that is not available from other jobbers.

To sell all equipment on terms financed by myself with less interest cost, less red tape, quicker delivery.

To take your equipment in trade at a fair value on other equipment.

To allow you to try any receiver for ten days without obligation and to cooperate with you in every way I can, to see that you are entirely satisfied.

Compare Bob Henry's Terms with others

Model of Receiver	Cash Price	Down Payment	12-Month Payments
The NEW RME-70.....	\$138.60	\$ 27.72	\$ 9.79
The NEW NC-44.....	49.50	9.90	3.49
NC80X and NC81X.....	99.00	19.80	6.99
Improved NC101X.....	129.00	25.80	9.11
The NEW NC100A.....	120.00	24.00	8.48
Latest RME-69.....	152.88	30.57	10.80
Sky Champion.....	49.50	9.90	3.49
Sky Challenger II.....	77.00	15.40	5.44
Breting 49 and Super Skyrider.....	99.00	19.80	6.99

Similar terms on Super Pro, HRO, PR-15, Breting 9, Sargents, others. And on Hallicrafter, National, Harvey, RME, Temco, RCA transmitters and National, Thordarson, UTC, Utah kits.

You can reach me by letter, telegram, phone, or visit nearly 24 hours a day, 365 days a year. Write me for help in choosing equipment for Christmas presents. Foreign orders also solicited. Your inquiries invited.

HENRY RADIO SHOP

211 North Main St.

Butler, Missouri

Bob Henry
W9ARA

Eliminate KEY CLICKS

without Loss of Power

Gardiner-Levering Mercury Vapor Keyer gives perfect keying on all GW transmitters — hand key, "bug," or machine sender — at all speeds, without loss of power output. Practically no voltage drop. Uses only one type 83 mercury vapor tube. Separate filament supply built in unit. Only 4 1/2" long and 3 3/4" wide. Merely insert in keying line and plug cord into AC outlet.



\$7

Less tube
POSTPAID
IN U. S. A.

FULLY GUARANTEED

If your dealer can't supply you, write us

GARDINER-LEVERING CO. Haddon Heights
New Jersey, U.S.A.

RADIO ENGINEERING



RCA Institutes offer an intensive course of high standard embracing all phases of Radio and Television. Practical training with modern equipment at New York and Chicago schools. Also specialized courses and Home Study Courses under "No obligation" plan.

Illustrated Catalog on request

RCA INSTITUTES, INC. Dept. ST-38

A Radio Corporation of America Service

75 Varick St., New York 1154 Merchandise Mart, Chicago

Tahiti — South Seas

Adventure cruise, 6 months. Yacht passengers wanted to share expense. Rare opportunity for Amateur Radio operator. Write:

H. J. Folster, Room 1109, 545 Fifth Ave., N. Y. C.

Save Money!

ASSEMBLE your own COAXIAL CABLE

WITH THIS

CO-X KIT

At last a 1/2" coaxial line at a price you can afford! Buy original Co-X components, all necessary parts for assembly — center and outer conductors, LIFETIME insulators, all hardware and instructions — in handy kit form and save important money. Ask your supplier today for kit, or send money order, check, or C. O. D. instructions to TRANSDUCER CORPORATION.

Kit K2B — 10 ft. — \$2.40, 25 ft. — \$6.00, 50 ft. — \$12.00.

Free descriptive literature on request

tc

Transducer CORPORATION

30 ROCKEFELLER PLAZA
NEW YORK

★
Professional Performance
FOR AMATEURS
 with the
NEW BRUSH MIKES

The Brush High Leveler Series is being greeted with cheers from the ranks of the amateurs. Model H.L. high level—46 db. comes complete with Vari-Swiv mounting and 25 feet of cable. List price \$23.50. The second in the series is the D-1 model which is especially recommended for better quality amateur P.A., recording, and amateur applications. Its level is — 62 db. with a response from 30 to 5,500 c.p.s. * 3 db. Complete with Vari-Swiv mounting \$23.50 list. Above microphones available with socket assembly in place of Vari-Swiv when specified.

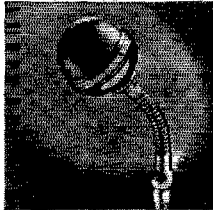

MODEL HL

Write for complete catalog

THE BRUSH DEVELOPMENT COMPANY
 3320 Perkins Avenue Cleveland, Ohio

We were located on a hill, tough to get to in dry WX, and the rain fixed things so we needed mud scoops to get in and out. Lightning struck something (we have not yet figured out just what) and stopped the 3 gas engines. While sparks seemed to tear all over the equipment, little damage was caused. It did burn down a wire fence nearby. We had planned an outdoor hamfest for Sunday evening, and while around fifty hams and S.W.L.'s turned up by 3 P.M., the WX generally put a crimp in the works.—*W8BLT-S*.

We were located on Connecticut Hill, elevation about 2100 feet, 18 miles from Ithaca. Our power source was entirely portable, being two motor generators. Two transmitters and two receivers were on the air continuously, both c.w. and 'phone. A large army tent provided sleeping quarters.—*Ithaca Mike and Key Club, W8QLU-S*.

We had two stations entered, W4CDC-4 and W4CBU-4. The operation of the two stations was intended to throw light on a good natured argument as to the best location for such a station. W4CBU and adherents contended for a QTH on top of one of the mountains with which this part of the country is so liberally endowed, and was operated from the top of Missionary Ridge. W4CDC held out for a low swampy place where the ground was damp, and was operated from along side Chickamauga Creek in a place so low and damp that at one time we had three cars stuck side by side. One trial is not conclusive, but on this occasion W4CDC ran up the better score.—*Chattanooga Amateur Radio Club*.

In connection with Field Day the Manchester Radio Club sponsored a Hamfest held at the location all day Sunday with about 40 visitors attending and looking over the equipment.—*W1DJC-1*.

Field Day is a grand opportunity of getting back into the real spirit of ham radio. Am looking forward to the next one.—*VE8AP*.

A word concerning our operating position atop Water Gap mountain might go well. The entire portable station was erected inside the forestry tower located on the highest point at Delaware Water Gap, Pa., on the Penna. side. We had excellent facilities for erecting antennas and operating.—*W3EEQ-S*.

We drew straws to see whose call we would use and W3GXI won. We drove down to the Shenandoah National Park and camped 15 miles south of Hog Wallow Flats on Skyline Drive. We think that an ideal QTH for 'phone use, don't you? Hi!—*W3GXI-S*.

Being in the automobile business we packed our equipment in a large van. Three of us stayed overnight "on location."—*W3MLM-S*.

We had a field day in Ashland this year for the first time. It went off with a bang—thunder, lightning and rain. Near Ashland in a park called Armeo we located with trailer, tent, gas driven generator, transmitters, receivers, grub, ice box, flies, chiggers, and ants. Being the first time, there was much to learn from trial and error. Maybe a ham thinks he is ready to set up in an emergency but after several weeks of preparation we found much to be ironed out at the final moment.—*W9BEW-9*.

W3GUT and W3ETQ put the antenna up by climbing a 125-ft. water tank on top of Haystack Mt. where we were operating.—*W3BHE-S*.

Was on 1950 kc., self-powered with 1½-19 tube xtl. osc. to ½ 19 neutralized amp. plate modulated by 19 in class A (parallel) with a "30" speech. Power input was 58 volts at .00095 amp. or 1/20 watt input to final. Worked W8RCJ for 1½ mile QSO at Q586 and received QSA1, S1 report from W8FYC listening 17 miles away. W8FYC had line noise bothering him. More fun than a circus.—*W3OMM-S*.

Things we pat ourselves on the back for:—We were ready and waiting at four P.M., because we started early Saturday morning. We tested out all equipment before F.D.; result no breakdowns. We made arrangements for rain; result it did not rain!! We cut and tapped both antennas at home. We made lists of equipment and needs, and did not trust to memory; result we did not forget anything. We used pulleys and weights on antennas; result no antennas broken in wind. Things we regret:—We were not equipped for 14 Mc. We did not have enough good operators; we needed one more. We did not catch up on sleep beforehand, result W8ELJ got sleepy. W8LGB did most of the operating, and the rest of us think he did a nice job of it, even though we won't win any prizes!!—*W8ELJ-S*.

W3ZD was not out to win this contest. We wanted to test the 3.9-Mc. 'phone portable in the Susquehanna 'Phone Net, without advance notice that we would be using low power. Contacts were made on schedule on the regular

○ ○
MEMORANDUM

- ✓ You need a copy of the new 1939 Handbook.
- ✓ You need a binder for your 1938 *QST's*—and another for 1939.

★



Xmas suggestion — give a membership-subscription or a new Handbook.

DECEMBER, 1938

SAVE AT THE RADIO SHACK



5-10 HALLICRAFTER
SKYRIDER
 Cash Price **\$69.50** or **\$12.50 Down**
 and **\$2.23** for 12 mos.

Here's a **REAL VALUE**
7258
X-CUT UNMOUNTED CRYSTAL **99c**
 From 7200 to 7500 KC.
 Supplied within 10 KC
 of your desired fre-
 quency.



S-17 HALLICRAFTER
SUPER SKYRIDER
 Cash Price **\$125.50** or **\$25.50 Down**
 & **9.00** for 12 mos.



GAMMATRON
 New Type 24
 Net price **\$3.50**
 Power out., watts 87.5
 Plate diss., watts 25
 Driver power watts 3.8
 Max. plate volts 1500
 Max. plate M.A. 75
 Amplification factor 25

TAYLOR T-55 **\$6**
 now reduced to

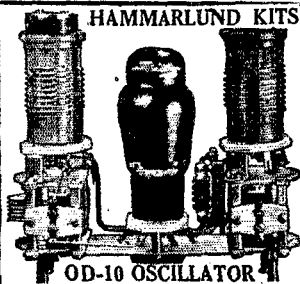

HAMMARLUND KITS
OD-10 OSCILLATOR DOUBLER KIT
 This "tri-tet" crystal oscillator and doubler kit is supplied with brackets and mounting hardware. Crystal mounting fits into coil form. One OD-10 found. unit, two MTC-100C cond., two S4 sockets, one S8 socket, one CHX choke, two SWF-4 coil forms. Less **\$7.69**
 6L6G tube and crystal

DB-40 BUFFER DRIVER KIT
 Employs RCA 807 or Raytheon RK-39. One BD-40 found. unit, two MTC 100C cond., two S4 sockets, one S5 socket, 1 CHX choke, eight SWF-4 coil **\$8.94**
 forms. Instructions hardware and brackets supplied, less tube.
PA-300 POWER AMPLIFIER KIT
 Incl. only Hammarlund parts **\$16.77**

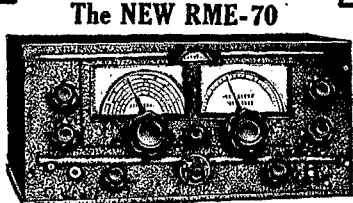

The NEW RME-70
 Features include a new illuminated DB-R meter, three new iron core IF transformers, automatic noise suppressor, break-in relay control circuit, improved audio characteristics, one-stage frequency amplifier, 10 tubes, streamlined cabinet.
CASH PRICE (complete with tubes and speaker) **\$138.60**
 \$27.70 down, \$10.15 for 12 mos.

MAIL ORDERS PROMPTLY FILLED
WRITE FOR FREE CATALOG
BUY ON OUR EASY TERMS.

A REAL MIKE VALUE!
TURNER TORPEDO CRYSTAL MICROPHONE
 Streamlined with aircraft aluminum and telephone black. Output level -60 db. Semi-directional with a minimum of feedback. Supplied with 8 ft. of low capacity mike cable. **\$8.97** Net Price

Special TRANSMITTING CONDENSER
 2 Mfds. **\$1.49**
 2000 volts
 Oil treated. Excellent power factor and capacitance characteristics.
 Tested at 6000 volts DC.



STANDARD RACK PANELS
 Made in accordance with standard specifications. Constructed of $\frac{1}{8}$ " steel, finished in fine black crackle.

1 3/8"	\$.39	1 3/4"	.79
3 3/8"	.44	1 7/8"	.89
5 3/8"	.49	2"	.99
7 3/8"	.54	2 1/4"	1.09
8 3/8"	.59	2 1/2"	1.19
10 3/8"	.69	2 3/4"	1.29

RELAY RACK BRACKETS
 Steel brackets finished in crystalline lacquer. Used to reinforce racks, chassis and panels.

5" base brackets (per pair) 33¢
 7" base brackets (per pair) 49¢
 9" base brackets (per pair) 65¢

Steel Brackets
 Black crackle finish. $\frac{1}{8}$ " steel.

8" base (per pair) 44¢
 11" base (per pair) 59¢
 13" base (per pair) 69¢

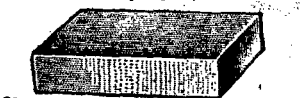

Chassis Crackle Finished and Electro Zinc Plated

5 3/4" x 9" x 1 1/2"	35c	10" x 14" x 3"	69c
5" x 10" x 3"	39c	10" x 23" x 3"	89c
6" x 14" x 3"	49c	7" x 17" x 2"	63c
7" x 7" x 2"	39c	7" x 17" x 3"	66c
7" x 9" x 2"	42c	10" x 17" x 2"	69c
7" x 11" x 2"	45c	10" x 17" x 3"	75c
7" x 13" x 2"	49c	12" x 17" x 1"	79c
7" x 15" x 3"	59c	12" x 17" x 3"	85c
10" x 12" x 3"	65c	13" x 17" x 3"	89c

*Available in Zinc, Plated only

THE RADIO SHACK 46 Brattle St., Boston, Mass.

Say You Saw It in QST — It Identifies You and Helps QST.

★
A NATURAL
FOR AMATEURS
the new
BRUSH HEADPHONES

BJ Headphone — A brand new model featuring hermetically sealed headphones enclosed in rubber jackets permitting good earseal. All rubber cord. List price \$12.00 per pair.



Model BJ

A-1 Headphone — Its high fidelity, wide range response and light weight make this instrument ideal for recording studios, speech correction and sound laboratories. Response is from 50 to 12,000 c.p.s. Complete with 5' cord, \$27.50 list.

Write for complete catalog

THE BRUSH DEVELOPMENT COMPANY
 3320 Perkins Avenue · Cleveland, Ohio

110 VOLTS AC

Anytime, Anywhere! with
Katolight Plants

Have special plant for operating radio receivers and transmitters. 110-volt voltage regulation. Full 360 watts AC and 100 watts at 6 volts. Filtered and Shielded. \$66.00
 Amateur's price

Other sizes up to 10,000 watts.
 Both gasoline and Diesel.

KATOLIGHT, Mankato, Minn., U.S.A.

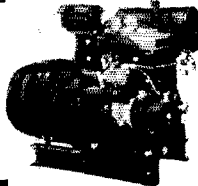

If you can use the regulation key —
 You can send **Better · Faster · Easier**

With This Great New

VIBROPLEX

No. 6



The Bug Trade Mark Identifies the Genuine Vibroplex

Great
 New No. 6

New design. You'll like its many special features that make it so efficient and easy to use.

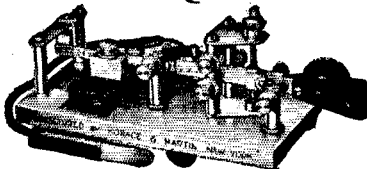

Japanned Base . . . \$17 Nickel-Plated . . . \$19

Its simplicity, mechanical perfection, machine speed and sending ease helps any operator to send with the skill of an expert. Eliminates tiring arm work.

Write for catalog of other models, including JUNIOR at \$12.50. Money order or registered mail

THE VIBROPLEX CO., INC., 832 Broadway, New York, N. Y.

frequency with no trouble. W3EIS wanted to test his 5 meter portable rig over greater distances than were possible from the home location. Every station heard could be contacted, and the test was eminently successful on this point. —W3ZD-5.

It took a lot of optimism to answer PK1JR's CQ on 7 Mc. with 33 watts after using a kilowatt for fifteen years, but one short call got results! —W6QL-6.

All work was on 56-Mc. 'phone with about 12 watts input. Worked 67 stations. —WINH-1.

We operated on Todd Hill, one of highest points on Atlantic coast, about 7 miles from home QTH. Power used was 5 watts running off small vibrator pack on storage battery. We worked 41 stations on 3.5 and 7 Mc. —W8HMJ.

Just as we completed setting up (in a covered truck) a small tornado tore through, rain, wind, lightning and the whole works. We managed to work our first station at nine o'clock, five hours later. Some start!!! This year's Field Day activity brought a number of things to light for us, namely: that low power is not to be sneezed at and that an inexpensive vibrator supply will do the trick where we thought that a gas driven generator was the least we could use for results in case of emergency and get through QRM and QRN. We also found that it would be an excellent idea for hams, individually and in groups, to prepare a list of necessary items to be procured in addition to radio gear, should the necessity suddenly arise for one to leave on emergency communication work. At the last minute there are bound to be things overlooked that will be needed. —W8HMH-8.

All operation at W9FUH-9 was on 14-Mc. 'phone. Conditions were a little tough for such low power. However, we worked 77 stations, and if you don't think 18 watts will go places, ask Frank, down at VK4JU. —W9FUH-9.

This was our first experience with portable equipment in the Field Day contest and everyone enjoyed the event. On arrival at the location a cat took up quarters with us. It must have been a relation of T.O.M.'s cat for it sure brought us good luck until it disappeared Sunday forenoon. —Radio Club of Tacoma, Inc., W7DB-7.

During the Field Day a test message was sent from Mr. C. G. Marcy, Chairman of the Schenectady County Red Cross Disaster Preparedness Committee to Red Cross headquarters in Washington. This message was sent by 56 Mc. from the Base Station to Schenectady and then forwarded by W2LU to Washington. Mr. Marcy personally visited the Base Station on Saturday afternoon and commented favorably on the set-up and the work being performed. —Schenectady Amateur Radio Association, W2DVC-2.

The Tampa Amateur Radio Club has participated in all A.R.R.L. Field Days with varying results, from winner to an also ran. This year, supplemented by a smooth operating low powered transmitter, built and owned by W4EUF and an old SW-3, a relic of many DX wars, belonging to W4AJX, all operating with batteries, and last but not least a real rabbit's foot, the Club was loaded for bear. Well, we may not win the Field Day, but no better time was had by any of the other participants. —W4DUG-4.

The antennae were set up Saturday morning. By the time the two V beams had been completed W5CMQ was quite an expert in the art of tree climbing. He made a specialty of going up cypress trees standing in ten feet of water out in the lake. And, just ask W5FVD if it isn't quite a job to thread 418 feet of wire through the bushes and trees in Black Lake swamp. —Louisiana Tech Radio Club, W5WG-5.

By the time the operating tent, mess tent, cook tent, and the pup tent for the gas engine driven, rewind Dodge generator were pitched the rain had started, continuing thru the night. Raincoats and hip boots were the order of the day. The gasoline lantern used in operating tent served a triple purpose: To give light, to heat the tent, and cook the mosquitoes that came in contact with it. —Hamfesters Radio Club, W9V8X-9.

Our 54 contacts were made with a 6V6-RK39 transmitter powered by two dynamotors hooked in series and run from a bank of storage batteries. Power input 18 watts. —Pike's Peak Amateur Radio Association, W9OKY-9.

The Helix Amateur Radio Club held its Field Day this year on Mount Helix. This mountain is located about 12 miles to the east of San Diego and rises to an elevation of about 1200 feet. Because of its elevation and freedom from power line disturbances it made an ideal radio location. —W8ANU-6.

A truck loaned to us was loaded with generators, rigs, tents, stove, grub, antenna poles, gasoline, water and all

(Continued on page 90)

SPECIAL PRICES
NEW GROSS CB-150
FINE QUALITY AUDIO

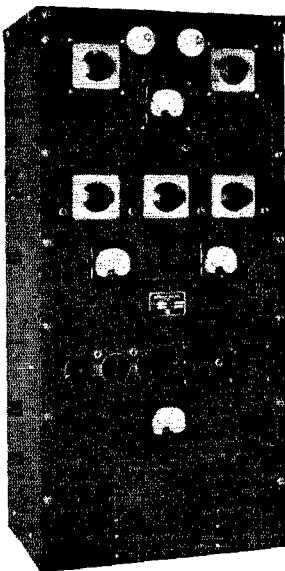

ONE MONTH ONLY
GROSS CB-150

**150 WATT PHONE AND
 CW TRANSMITTER**

Complete With One Set of
 Coils for Any Amateur Band.

\$160

Complete Set of Tubes . . **\$20**

Crystal Mike, Stand and
 Plug **\$16**

Input — 150 Watts
 Phone and CW

Coils Available for 30, 14, 7,
 3.5, and 1.7 Mc.

Class B Modulation

All the Very Latest Type
 Tubes Used Throughout

Completely Self Contained

GROSS CB-55—POWER 95 WATTS GROSS CB-250—POWER 250 WATTS

Descriptive Bulletins on Request

20% DEPOSIT WITH ALL C. O. D. ORDERS
GROSS RADIO, INC.

REMIT BY M. O., INCLUDE POSTAGE

Cable Address: GROSSINC
51 VESEY STREET, NEW YORK CITY

DIFFERENT MAKES OF TUBES LOOK ALIKE



But they don't test the same or perform alike. Better
 engineering makes Ken-Rad Radio Tubes consist-
 ently superior. Try them. You'll be convinced.

Ken-Rad Radio Tubes
KEN-RAD TUBE & LAMP CORPORATION - OWENSBORO, KY.

Manufacturers of all types of radio tubes and Ken-Rad Electric Lamp Bulbs

LEARN RADIO
—TELEVISION—

500 Licensed graduates placed in past 7 years in shipping,
 broadcasting, aviation, police, etc.; we also teach radio
 servicing and repairing; new term Sept. 12th, Nov. 7th day or
 eve.; 52-page catalog free; oldest, largest and best equipped.

MASS. RADIO SCHOOL

18 Boylston Street, Boston

G. R. Entwistle, Pres.
 Established 1899

R. F. Trop, Treas.
 Hancock 8184

NEW HAMMARLUND MODEL HQ-120

Described on Page 57

Down Payment Only \$9.55

COMPARE THESE LOW TERMS

And Send Your Order Direct to W3DQ

Receiver and Model	* Net Cash Price	* Down Payment & 12 Mo. Pay'ts
New NC-44	\$49.50	\$4.04
New RME-70	135.60	11.30
New NC100XA	142.50	11.70
Super Skyrider	99.00	8.08
Sky Challenger II	77.00	6.28
NC101X	129.00	10.52
New HQ-120 complete	117.00	9.55

Also Super Pro, HRO, Patterson, Bretting, Sargent and Others
 Lowest Terms on Harvey—RCA—Temco—National—
 Thordarson—Transmitters & Kits

DELAWARE RADIO SALES COMPANY

WILLARD S. WILSON

405 Del. Ave.—W3DQ—Wilmington, Del.

**For U. S. A. only. Subject to change without notice.*

**Station Activities
DAKOTA DIVISION**

NORTH DAKOTA—SCM, Ernest Bloch, W9RZA—The Grand Forks Radio Club is holding a QSO contest. The ham members were divided into two teams, the object being to work as many different stations in as many different states as possible—the final “payoff” to be in the form of a feed put on by the losing team. ITI is a new ham in Hatton. ZGR is busy rag chewing and handling traffic on 1.75-Mc. 'phone. JWB made a ribbon mike. ZTL worked K7FZD who was formerly of Fargo. JZJ sold his entire station and will have a new one soon. DM has a new rig with 6A6 and RK39 for 3.5 Mc. and a P.P. RK39 rig for 14 Mc. YVF has new Stancor 100 'phone rig and is O.B.S. and O.P.S.

Traffic: W9ZGR 9 ZTL 5 RZA 2.

SOUTH DAKOTA—SCM, A. L. Russell, W9VOD—SEB: R.M. OXC: O.B.S., O.O. The Section lost one of its A-1 reliables when AZR moved to Sioux City and a better job. “DA” was A.A.R.S. S.N.C.S. from “way back when” and our only B.P.L. Very 73 from the gang! Following acquisition of a Jr. op, VQN gets a noise silencer. Hmmm! ONV is a new bridegroom. FOQ finally worked a Nevada station that promised to QSL; if it comes through, Gus has W.A.S. TY is back on the air from Northville, working e.c.o. on 3.5 Mc. WYL is new A.A.R.S. in Aberdeen. USI visited QVY, FLO and QVT are working 56 Mc. FLO is building an emergency rig for 3.5 and 7 Mc. QVT has a new rig on 3.5 Mc. GYG rebuilt his 'phone rig. DZD, ILL and KYZ are new calls in Huron. WPA is busy with 17 college hours and 16 working hours but got his rig rebuilt as far as the 6L6 buffer for the opening of the A.A.R.S. season. SEB succeeds AZR as S.N.C.S. in the A.A.R.S. net. LMC is putting up new antenna; his XYL operates LLG with T55 final on 1.75-Mc. 'phone. OQQ and OQG are planning a T125 final on 1.75-Mc. 'phone. YNW is back on the air. ADJ got the new rotary beam up and perking. YKY has new modulator. CJC is talking a new high-power 'phone job. KNV is building a new rig with 6L6's final. YJX has his rig on 3.5 Mc. At its annual picnic the Rapid City club had YQN and ZYD as visitors; elected YKY pres., YJX vice pres., KNV sec'y, and YOB treas. We regret to report the death of QLP of the A.A.R.S. gang. GLK and TAV have nice signals on 1.75-Mc. 'phone. WFL takes a Havana vacation. ZCC is arranging a traffic bureau at State College. Note that your S.C.M.'s address is now Philip.

Traffic: W9SEB 92 FOQ 22 VOD 14 VQN 12 ZCC 10 WPA 6 YOB-QAK 3.

NORTHERN MINNESOTA—SCM, Edwin L. Wicklund, W9IGZ—The Dakota Division QSO party will be held the week-end of January 14 and 15. Complete details will be given in next QST. HEN spends most of his time with traffic, has schedules with BNT and WKB. KQA is putting up new antenna. St. Paul Radio Club Powwow was a big success. PKO is pounding away on 28-Mc. 'phone. ZGU has new Sky Champion receiver. JIE has new 400 watt rig. ZWW put up a rotary beam for 28 Mc. HEO likes his new 81X receiver. UDK is trying a crystal earphone for a mike. RJF hooked up with MWV for life. Congratulations, and may you have a happy married life. YAP has a new pair of T55's for his rig. PZU is sending the A.R.R.L. broadcasts at 7 p.m. each Sun. and Wed. on 3903 kc. Now that winter is here with more activity, please send some more reports. Best regards to all—Ed.

Traffic: W9YCR 2 HEN 83 IGZ 3.

SOUTHERN MINNESOTA—SCM, Millard L. Bender, W9YNQ—MZN has his rig going again. ZAD has a fine new e.c. rig. KUI is starting with an RK-20 and going to build backwards for a change. GMD is new O.R.S. with a nice report. OEN is a new ham just moved to St. Paul from Missouri; he is looking for schedules on 7 Mc. WDL has a pair of nice 60 foot lattice towers and is ready to go on 1.75-Mc. 'phone. VRY worked both coasts the same night with 15 watts. ZAD, YZW, VRY and ZSX are as busy as an old ladies' knitting bee during their noonday QSO's. DEI has practically a new outfit. GLE and WAO are on 28 Mc. ZSX applied for O.P.S. ZNY, GFA, FNK, ZAD and YNQ are reporting regularly in the A.A.R.S. UKB is S.N.C.S. with HEN as N.C.S.-two. The Rochester Radio Club had a very interesting meeting. The chief engineer of the Johnson Company of Waseca gave a very interesting talk on antennas. Mr. Young, Director of this Division, gave an enlightening talk. Plans were laid for the S.M.R.A. convention at Mankato. UPO visited WDL. UPO and TPZ have a nice

new shack located south of Austin on the highest point in Mower County; they work mostly on 14 Mc. DCM has been reborn; the owner forgot that rule 410 applied when a license is endorsed for Class “A.” The S.M.R.A. held its convention at Mankato November 6.

Traffic: W9GMD 45 YNQ 13 MZN 3 ZAD 1.

CENTRAL DIVISION

ILLINOIS—SCM, Leslie M. Dickson, W9RMN—ATS was off the air temporarily when his antenna pulled the chimney over! YES needs Africa for W.A.C.; he's been working some rare ones lately. JTK, a new ham in Watseka, is a real old timer; he would like to contact other Western Union employees and old vets of the Signal Corps. BE still has that daily schedule with KA1FG. DBO needs Nevada and New Mexico for W.A.S.—come up on 3.5 Mc., Elmer, and we'll get 'em for you in one evening. Although GYK is W.A.C. on 'phone many times over, he isn't satisfied; he wants an S9 W.A.C.; four Vee beams are helping him along. GBT reports a barnyard network in Sterling and vicinity. EBX wants more late evening schedules. CFV is back on the air on 28-Mc. 'phone. BRX is now in Wheaton. UAT is rebuilding. AMP is on with 700 watts. HPG and RMN are looking for recruits, HPG for the A.A.R.S., RMN for the ILN state net. If you live in Illinois and operate on 3.5 Mc., you don't know what you're missing if you don't belong to one of these nets. All nets are on 3765 kc. For more information get in touch with HPG or RMN; no obligation on your part.

Traffic: W9EBX 171 RMN 140 (WLTR 307) HPG 68 (WLTI 45) NFL 66 VEE 47 (WLTO 6) DDO 45 VES 41 MRQ 32 TUV 16 QKJ-VSX 15 VS 11 PRS 10 KMN 9 ATS-HQH 8 BE-YDJ-TZQ 7 NHF 6 PNV-TFA 3 CUH 1.

INDIANA—SCM, Noble Burkhardt, W9QG—AB is on A.A.R.S. schedules occasionally. ANH is attacking the bugs in RK-12 final. ARK is trying to chisel a couple of old poles out of the light company for a new 14-Mc. beam. DBJ has SJK beam working north and south. DET is building a “QSL 40” transmitter and bought a Sky Champion receiver. We are very sorry to report the death of W9DSZ. Indiana loses an active amateur. FB built an FB frequency meter. GOE is active on 28-Mc. 'phone. HUV put up Vee beam for 28 Mc. KBL averages one QSO per week. KPD sold out. KUF is new ham on 7168 kc. in Whiting. LDV got some new tubes for transmitter. LG is still in transmitter building stage. LHK is new ham in Hammond. LKI is back on the air. LQE is on 14-Mc. 'phone again with 75 watts input from gas driven generator. MUR has two T-40's with 144 watts on 'phone and 250 watts on c.w. NGS built a small rig to operate from his home location. PWZ sends news from Ft. Wayne. QG is building frequency meter to meet new F.C.C. requirements. QVQ sold his rig to QPU. SWH is new member of A.A.R.S. TBM is holding down trunk line “L.” TMP gets into Ft. Wayne occasionally. TRN has new close spaced 14-Mc. rotary. UNS worked 3 G's on 28 Mc. 'phone using P.P. 10's. USU is putting up an SJK on 28 Mc. UUN has e.c. exciter and races from one end of 28-Mc. 'phone band to the other with FB signal. VJV has new rig and worked his first K6. VNY is a freshman at Purdue. WCE has new Howard 450 receiver. WDV has active 28-Mc. 'phone. YB is handling traffic with A.A.R.S. YCZ has new beam antenna. YMV signed up for A.E.C. YQV puts out a nice 'phone signal on 28 Mc. YWE will soon have more power. ZBR has been working S.C. Africa regularly on 28 Mc.—great stuff for a chairwarmer. ZNC received R.C.C. certificate. ZYK bought parts for 14-Mc. rotary. EGQ worked 6 new countries. ILL and OOG have 100 watts. MBM has new rotary beam. SXU got married. YQV is new president of the F.W.R.C., which meets on the second and fourth Fridays at the Chamber of Commerce building in Ft. Wayne. The Purdue Radio Club is holding classes in Class A and B theory in addition to code classes.

Traffic: W9AB 5 AXH 3 LDV 67 MYL 32 NGS 20 QG 133 (WLHL 125) TBM 44 (WLHW 8) YWE 43 ZNC 7 EGQ 4.

KENTUCKY—SCM, Darrell A. Downard, W9ARU—Attendance at the A.R.T.S. meetings has perked up due to prizes donated by our local radio dealers. BAZ inspected the N.Y.C. Fire Department's radio set-up and says it's “hot stuff.” (No pun intended.) EDQ is getting the U. S. Engineers at Cincinnati fixed up for their river traffic to Engineer's Office at Louisville. In addition to the Ky. Net giving the Louisville Office river gauge readings at several dams daily, information is also being furnished hours in advance of ar-

rivals of boats at the canal at Louisville on the number of barges in the tow to facilitate handling at the canal. TLZ is DXing on 14 Mc. NAR has a new shack and works 14-Mc. 'phone. NBD snagged three K6's, a VK6 and a ZL one night. UKD is on "KYN" regularly—but who wouldn't be with 15 operators! ELL handled a lot of the eastern flood traffic. AUH works a schedule on 7 Mc. BEW is back on the air after several weeks' illness. WXL is using a new beam on 14 Mc. GAQ has a 500-watt 'phone going. JDI is building new 1.9-Mc. outfit. WUR added an amplifier to a 61.6 job. EI is moving back to his first love, Lexington. HAX is going strong on "KYN." ALR is rebuilding—again. YQN has completed rebuilding and runs 250 watts to a pair of T40's.

Traffic: W9BAC 135 ARU 109 HAX 91 EDQ 86 ELL 72 UKD 46 CDA 41 AUH 7 NBD 6 YQN 2.

MICHIGAN—SCM, Harold C. Bird, W8DPE—Michigan Eight's: NUV is down in the 5th district going to school. Lots of luck, Vic. HUD, operating portable from the East, would like traffic from QMN boys for eastern points. RVE is O.R.S. and is looking for eastern schedules. DSQ is still under the weather. Lots of luck, Rudy. QZH moved, has skywire up and ways watch out now. FWU suggests O.B.S. for Michigan Net. BQA has been installing remote control and added b.f.o. and S meter to receiver. BMG is trying to build new rig and operate at same time. KNP will be with us soon. GUN is back on QMN. JZD is getting his planning committee together for emergency work. JUQ joined A.A.R.S. NQ is trying to work QMN and 1.75-Mc. 'phone. DED is playing with 14 Mc. DYH reports 14 stations added to QMN Net making a total of 1451 DOI wants boys to QSY for rag chew after QMN net. FTW is out for traffic in big way this season. QGD has single-signal working FB for traffic work. PLC reports by radio. OXM is chef for the Oakland Radio Club. RBV acquired an SW3. MPX is using his RK-20's while T-200's are in factory. OLD is rebuilding rig with pair of '46's. PBP is building portable rig. PBP is looking for contacts on 1.75 Mc. SLU just got ticket. Congratulations, OM. PSH is getting nice rig ready for QMN. MCV is trying to learn American Morse. PYT is doing nice job on QMN at Flint. SH reports SHI, NVO, RCR, ROH, PVD and AYO all new ops at college. RQE won the field day first prize. Congratulations, Chuck. LSF reports QGD as alternate on T.L. "A." MBM keeps daily schedule with 9GVN at Wetmore. Michigan Nines: GJX, Helen, wants the QMN gang to get up in the morning so she can QSO. CWR is trying to organize a net for 6:15 p.m. daily in U.P. IIT, Vee, says she will not be active this year on account of teaching in Calumet. Sorry to lose you, but lots of luck. CE says U.P. is getting ready for big season. SDG is rebuilding 9YX with P.P. 211's. Well, gang, you will find the QMN net schedule in O.R.S. bulletin. Hope you fellows will all be on your toes in case of an emergency. If you have not joined up with Emergency Corps, do so now. You owe it to your community as well as yourself.

Traffic: W8QGD 536 JZD 162 FTW 142 (WLTY 42) IXJ 107 DYH 108 PLC 90 CMH-RVE 87 LSF 63 BRS 41 PYT 47 JUQ 38 DOI 37 FX-BMG 78 NUV-PSH-FWU 20 DPE 18 MBM 16 GUN 14 QZH 10 GQQ 12 RQE 6 RJC 7 SSE 5 OCC 5 JAH 3 MCV-DSQ 1. W9GJX 17 SDG 5 CWR 2.

OHIO—SCM, E. H. Gibbs, W8AQ—Ohio Regulars spot frequency has been changed to 3730 kc. HCS and BBH are at the top of the heap in traffic again this season. LVU is net control of the Regulars and in trunk "M" besides. WE has been transferred to Findlay. HKR, LCW, RFF and RIX are O.R.S. prospects. PGI has been working DX besides keeping A.A.R.S. schedules. 9YML/8 divides time between Ohio and Indiana. APC is editor of fifth C.A. bulletin. SCT is increasing to high power—25 watts. Hil RVL is member of National Guard net. OTT rebuilt rig and is handling traffic again. Rig at LAU has gypsy fever, dividing activity on four bands. RIX increased to 100 watts and has new JK beam working fine. BDM is getting home station on the air. KNF hated to miss Oct. O.P.S. party, but was on trip to New Orleans. KKH has been experimenting with Faraday screens. PBX is on 14 Mc. seeking W.A.C. and W.A.S. JFC has new pair of 809's in final on high frequencies. AVH is new O.P.S. IAI raised antenna to 62 feet with improved results. OVL has been building tower and motor controlled rotary beam. SLB is new ham in Cheviot. PKS completed new compact 28-Mc. rig. DXB has new 14-Mc. beam and 56-Mc. superhet. EMV is rebuilding. CDR is erecting tower for rotary antenna. FHB put in new power mains but is still on low power. OZH is very busy at Western Reserve. PUN has new scope and new steel mast. PRW is making 28-Mc. rig.

Traffic: W8HCS 188 BBH 174 (WLHA 438) LVU 137 LZE 106 KIM 90 WE 69 NKU 59 MUR 56 AQ 40 LCW 38 PGI 35 PIH 32 HKR 25 KNF 15 APC 13 LZK-KKH 12 NXN 11 LCY 10 CVZ 9 FSK-BAH 8 HFR 6 NOT 5 PBX-EQN 4 JFC 3 AVH-RFF 2 OTT 5. W9MYL/8 32.

WISCONSIN—SCM, Aldrich C. Kronos, W9UIT—RNX has new double-double zepp working fine. IYL is making his O.B.S. schedules regularly. ESJ on first report tells of handling flood traffic. UIT joined the new Police Operators Net which is getting started on 3715 kc. HGF is back in State Net with the old enthusiasm. DXI is active on N.C.R. schedules on new frequency of 2820 kc. HSK is putting his shoulder to the wheel once more in the State Net. AKT moved to new QTH and has been elected president of Four Lakes Radio Amateur Club. SZL, the old reliable, is back in harness with his many activities. UFT took a canoe trip in the Canadian wilds, visited ZHK and VE3ABM. FHA, a new ham, sends his first report. YXH deserted DX hunting and is now active in the combined A.A.R.S. and State Net on 3775 kc. The Milwaukee Club is exhibiting at Milwaukee Auditorium Hobby Show and will have 1-kc. rig in operation besides many exhibits of ham gear, DX cards, etc. PRM and ESV have new Jr. ops. CFT has a 35T replacing the old tens. FEO had another QSO; that makes two this year! VBC is interested in DX. The Wausau Club is going to buy two portable a.c. generators for emergency equipment. ZTO is going to furnish the gas engines to drive them. Think it would be a fine thing if all the clubs in the state had an emergency rig ready for use, even if it is used only once a year at the annual ham picnic, or Field Day. DXI is on 1.75 Mc. using portable with FB quality and lots of sock. HDP will be on 'phone very soon. DPR is holding up his end in Wisconsin Net. ONI is now Alternate N.C.S., A.A.R.S. and AKT got S.N.C.S. appointment. QXZ finally got ambition to build rig of his own. PSC is building new speech amplifier. KJB is getting the bug again.

Traffic: W9ONI 18 (WLTN 5) HSK 6 (WLTD 6) SZL 32 AKT 2 HGF 4 ESJ 13 UIT 3 ZTP 16 YXH 29.

MIDWEST DIVISION

IOWA—SCM, Clyde C. Richelieu, W9ARE—DUA is new O.R.S. and R.M. JMX is active in A.A.R.S. again. Congrats to REH on FB traffic total—we need more of this type. LCX is Iowa A.A.R.S., N.C.S. Glad to hear TGK back in the swing. ZQW comments on BNT's FB speed tests. QGL is new Mystic station in A.A.R.S. net. UUE is attending Iowa State. YMZ reports from Shenandoah; he is engineer at KMA and is working 28- and 14-Mc. 'phone. AWH reports transmitter and receiver all overhauled ready for big season. YQY's objective: W.A.S. by Jan 1. YRO is operating portable from Ames. OLI is active on 7 Mc. YTJ swears by his new receiver. ZUO has new Howard receiver. AED please send in that O.P.S. application. DNZ has 211-A on 14 Mc. DLT has RK-20 on 'phone. IBR moved to the land of sky blue waters, Minnesota. YJJ and FYC registered in the A.E.C. ARE is experimenting with beam antennas of all descriptions out on "Radio Farm," 2 miles south of Burlington. PJR moved to the country and is now looking for a Dodge generator. WTD has new power transformer. LAC reports excellent results on 28-Mc. 'phone since putting up 3 half waves out of phase vertical a la 9PJR. WNL and CTQ assisted with counterphase installation at KCEJ for Uncle Sam. TMY is putting in 'phone. RZV rebuilt and is going strong on 1.75 Mc. QOQ is on 1.75-Mc. 'phone from Ft. Madison. QVA schedules his brother on east coast. NVF joined Navy, is now at Great Lakes, Illinois. We regret very much losing an excellent operator and station but know the U. S. N. will profit by our loss—see you in 4 years, Wayne. We are glad to see the decided increase in traffic totals this month—we hope this trend will continue. We would also like to see more participation in the various A.A.R.L. O.R.S.-O.P.S., R.M., etc. contests—not until you enter one of these contests can you realize the fun to be had contacting the cream of the operating class, old timers and old friends. An Iowa All-state Net for traffic is planned and any stations desiring to work in this net contact your S.C.M.—spot frequency crystals will be supplied at a very moderate cost through 9TMY and we want every county in Iowa represented if possible. This Net for the State will also serve for emergency work. All O.R.S./O.P.S., E.C., R.M., and other A.A.R.L. appointees please make an effort to report to your S.C.M. monthly so that you may be given credit and mention in QST.

(Continued on page 92)

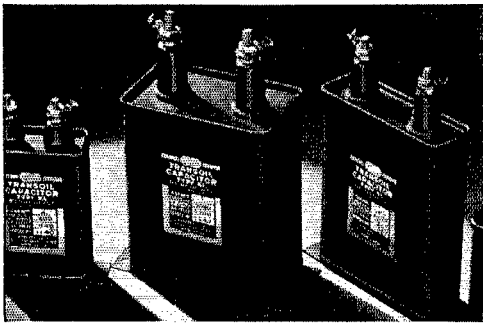

TRANSOIL

for transmitting

**HIGHEST QUALITY
OIL CAPACITORS**

Write for Catalog 2-X
listing complete lines

TRANSOIL—SOLAREX—TRANSMICA

SOLAR
MFG. CORP.



599 BROADWAY
NEW YORK CITY

Amateur Radio Licenses

Home study course and residence courses in code and theory. Reasonable, efficient and thorough. Results guaranteed. AMERICAN RADIO INSTITUTE, 1123 Broadway, New York, N. Y.

PRECISION CRYSTALS

Highest quality crystals carefully prepared for frequency stability and maximum output. Rigidly tested to assure you of dependable operation. Be sure of your transmitter frequency — use PRECISION CRYSTALS.

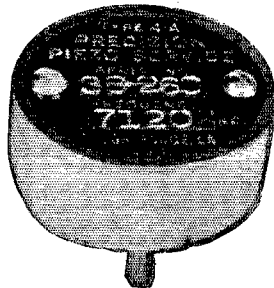

Type 4-A low drift unit plugs into a tube socket. Supplied within 5 Kc. of your specified frequency in the 40, 80 or 160 meter bands. Calibration accurate to within 0.03%. Price, \$4.50.

*'X' cut crystals supplied in type 4 holder for tube socket within 5 Kc. of your specified frequency in the 40, 80 or 160 meter bands. Price, \$4.00.

Either the low drift crystals or the 'X' cut type can be supplied in square holders to plug into G.R. type jacks at the above prices.

Crystals for commercial requirements quoted on at your request. Now in our ninth year of business.

PRECISION PIEZO SERVICE
427 Asia Street Baton Rouge, La.

(Continued from page 86)

the other things we could think of and away we went. Six 24-foot poles were set up, four antennas strung and two tents set up; equipment was set up in the tents and truck when a wind of about fifty miles per hour came up and promptly blew down two poles and one tent.—Ogden Amateur Radio Operators Club, W6ETB-6.

The Central Colorado Radio Assn. located at Daniels Park, Colo., about 20 miles south of Denver. This excellent location is about 1000 feet above the surrounding river valleys to the west, north and south. Care had to be used so as not to disturb rattlesnakes which infest the region.—W9ZOD-9.

Our rig used was entirely dry battery operated using 2 volt tubes, a type 30 crystal oscillator into a 49 amplifier, input of 3.75 watts. 3.5 Mc. band was used almost exclusively, only one contact being on 14 Mc. The antenna was a matched impedance type single wire fed coupled to the rig with a pi-section filter. The receiver consisted of a pair of 230's detector and audio.—W1AWY-1.

Field Day Participation

Club Station	QSOs	Score *
W9AIU-9	Egyptian Radio Club ¹	317-A-4 3708
W3BKX-3	Frankford Radio Club ²	156-A-2 2341
W2AIW-2	Jersey Shore Amateur Radio Association ³	165-A-3 2178
W3QV-3	York Road Radio Club ⁴	147-A-5 2070
VE3AJV	Frontier Radio Club ⁵	121-A-2 1899
W9RBI-9	Dells Region Radio Club ⁶	157-A-2 1800
W6NOI-6	The Glendale Amateur Radio Society ⁷	138-AB-3 1608
W6CL-6	United Radio Amateur Club ⁸	153-A-1 1602
W8AU-8	Utica Amateur Radio Club ⁹	112-A-2 1584
W9SRB-9	The Northwest Amateur Radio Club ¹⁰	165-AB-3 1565 rt
W9YKK-9	Monument City Radio Club ¹⁰	104-A-2 1548
W1AAJ-1	Green Mountain Radio Club ¹¹	106-A-2 1512
W1JHT-1	Bridgeport Amateur Radio Association ¹²	129-B-3 1510
W8KG-8	Buckeye Short Wave Radio Association ¹³	112-A-2 1503
W6RR-6	Mike and Key Club ¹⁴	197-AB-5 1482 rt
VE3KM	Hamilton Amateur Radio Club ¹⁵	102-A-3 1404
W9KYC-9	St. Paul Radio Club ¹⁶	99-A-3 1395
W3AIR-3	Trenton Radio Society ¹⁷	98-A-3 1377
W1BFT-1	Merrimack Valley Radio Association ¹⁸	90-A-3 1314
W5BRX-5	Tulsa Amateur Radio Club ¹⁹	98-A-5 1251
W9BA-9	York Radio Club ²⁰	127-A-3 1218
W2ABS-2	Skywire Radio Association ²¹	105-A-2 1206
W3BGD-3	Beacon Radio Amateurs ²²	79-A-2 1179
W3GKI-2	Tri-State Radio Club ²³	85-A-3 1176
W9YWX-9	Sheboygan Radio Amateur's Club ²⁴	127-AB-3 1140
W8AVH-8	Westlake Amateur Radio Association ²⁵	76-A-5 1125
W6KZ-6	Palomar Radio Club ²⁶	88-A-3 1090
W4EQK-4	Clearwater Radio Club ²⁷	91-A-1 1089
W9WJD-9	Wausau Radio Operators Club ²⁸	72-A-1 1080
W9TLC-9	The Austin Radio Club ²⁹	74-A-1 1053
W9LVA-9	Sedalia Amateur's Radio Club ³⁰	98-BC-2 1053
W8QLU-8	Ithaca Mike and Key Club ³¹	75-A-2 1008
W4CDC-4	Chattanooga Amateur Radio Club ³²	64-A-1 999

(Continued on page 94)

* The "power classification" used in computing the score is indicated by A, B, or C after the number of QSOs shown. A indicates power up to and including 20 watts (multiplier of 3); B indicates power over 20 up to and including 60 watts (multiplier of 2); C indicates over 60 watts (multiplier of 1). More than one letter means that at different times different power inputs fell within different classifications. An R or T after the score indicates that receiver or transmitter were supplied from the public mains; no indication after scores where work was entirely independent of mains, r or t is used where only part of operation used mains supply. The numeral following the letters A, B, C, etc., indicates the number of complete units (transmitter plus receiver) in operation simultaneously.



BUILDING INVISIBLE GAMMATRON QUALITY

Many of the elements responsible for the phenomenal performance and long length of service of GAMMATRON tubes are invisible. The manufacturing technique, engineering skill and years of successful experience in the amateur, broadcast and commercial fields are qualities which are not readily seen in the finished product, but are immediately apparent when the tube is placed in service. There is a GAMMATRON that will do your transmitting job at lower cost per Q. S. O. and with greater ease. See your dealer or write for data on the full GAMMATRON line, from the 54 to the 3054.



Christmas Seals
help to protect your home
and family from tuberculosis

BUY and USE them
on your Holiday mail

The National, State and Local
Tuberculosis Associations in the United States

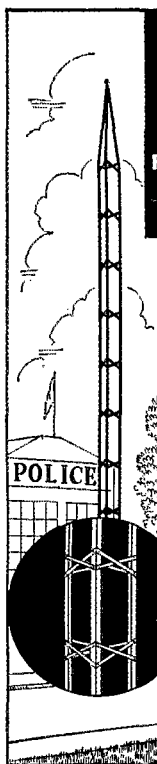

LOW COST STEEL ANTENNA TOWER

Used and Endorsed by
**FEDERAL, STATE, COUNTY, CITY GOV'TS.,
FORESTRY, HIGHWAY PATROLS
and HAMS everywhere!**

ONLY 60¢ PER FOOT Complete!

This remarkable low price is possible only because we produce many thousands of these towers each year for use with our Wincharger. Price includes necessary guy wires and lower sections of 10 or 20 ft. lengths with 3 ft. tapered stub top.

LIGHT, STURDY, RIGID

Thousands in use as vertical radiators and horizontal antenna supports. Scientifically braced. No points of undue strain. Both vertical angles and cross braces now hot dip galvanized.

SAFELY ERECTS TO 200 FT.

Quickly and easily erected, without skilled assistance, to heights of from 25 ft. to 200 ft. Enthusiastically used and recommended by police and broadcasters for thoroughly satisfactory service.

READ U. S. FORESTRY LETTER!

"Your tower was installed on Signal Peak, a Lookout Station on the Yakima Indian Reservation, at an elevation of 5,111 ft. above sea level. We have found the Wincharger tower 100% satisfactory and it has stood up under 70 mile winds, snow and ice which are severe at almost a mile up from sea level." Thomas L. Carter, Forest Supervisor, Office of Indian Affairs, U. S. Department of the Interior, Toppensish, Wash.

Order Direct From
WINCHARGER CORPORATION
Sioux City, Iowa

(Continued from page 89)

Traffic: W9DUA 18 JMX 10 REH 212 LCX 235 TGK 11 ZQW 57 LEZ 44 (WLUD 24) AWH 20 ARE 52 QVA 4.

KANSAS—SCM, Harry E. Legler, W9PB—The Coffeyville Club is now affiliated with the A.R.R.L. and invites all hams to visit them on Thursday meeting nights. The secretary, RAT, reports that: TKF's Harvey 80T does things on 28- and 2-Mc. 'phone, QOI does his operating at the High School station and studies at home. YQD keeps early morning hours on the 2-Mc. 'phone and Sunday A.E.C. net. YLY modulates a 6L6 on 28-Mc. 'phone. EFE is on his 8th A.A.R.S. year, RAT has his rig back on 4-Mc. band after a recent move but looks longingly at 28 Mc. WIN learned by ham radio of his son's safety after the eastern hurricane. AIJ has sold his equipment and expects no more ham work for years. Bet he is back inside of a year. EJD is building a 1-kw all-band transmitter. YRN and YAH visited MKU. QQT is Dixing on 14 Mc. QNB is rebuilding to use 35T's in the final for 14 and 28 Mc. The Eldorado Club is preparing to entertain the Wichita Club. This report is the twenty-fourth and probably the last one for this S.C.M. Our two-year term as S.C.M. expires this month. W9UEG has been elected our new S.C.M. We urgently request you to give him all the cooperation that an S.C.M. deserves. We have made many new pleasant contacts and acquaintance by reason of the S.C.M. work. We shall cherish them through the years. 73.

Traffic: W9UEG 114 WIN 77 QQT 8 YOS 6 QLI 3 ZJE-MKU 2 HCG-HUR 1.

MISSOURI—SCM, Letha Allendorf, W9OUD—The Missouri net is going fairly well with several regular netters, among them ZVA, ZVS, VZQ and QXO, who is also alternating for PYF on T.L. "K". ZJK is rebuilding, using a 6L6, 809 and P.P. 809's. QOB and his new receiver worked VQSAI. RIP is using a fence post, pending erection of a mast. OJL joined the A.A.R.S. RJP worked with T.L. "AP" for a while until junior college interfered. JAP resigned T.L. "H" post but is continuing in A.A.R.S. HVT has a new rotary beam which really works; he and UYD relayed traffic on 14-Mc. 'phone during the hurricane emergency for eastern stations. EFC has a new QTH in Richmond Heights, which is still St. Louis, and has a thousand volts on a ten. KIK is back from California ready to handle some traffic. RNK is back on c.w. after a trial at 1.75-Mc. 'phone. UAB is rebuilding 'phone rig. DHN finally got on the air again after acquiring an XYL last May. EYM is working 1.75- and 14-Mc. 'phone. LLW is operating portable from Dallas. SNZ, attending Kansas State College, schedules his brother, QAU, from QML. QAU has 41 states toward W.A.S. and is going to K. C. Junior College with QIP and YWT. YTH is at Rolla School of Mines. VMH is busy with school but takes time out for a few schedules to keep his checker game in form. KOS is a new ham in Unionville. VZQ is a regular member of the state net. KJM has been working DX on 14 Mc.-'phone with 25 watts. TGN took part in the after-dark antenna party at QJP. The Ozark Empire Radio Club in Springfield meets the first and third Wednesdays of the month and has thirty members. FMM and XYL visited OUD. QCO is still making tracks with his rig using P.P. tens. JXG is with the state Highway Patrol Radio Station in Springfield. 5GZG-ex91GW, has taken a job with Pan American. SHR is still studying figures at Indiana U. OUD is trying to find some new O.R.S. for trunk line jobs and traffic schedules. Thanks for the FB bunch of reports. The more the merrier and everything.

Traffic: W9OUD 283 TGN 210 QXO 102 PYF 81 EFC 24 RJP 20 HVT 17 VMH 14 ZVS 10 EXM 2 KIK 1.

NEBRASKA—SCM, S. C. Wallace, W9FAM—DI reports Trunk Line "B" going fine. KPA is alternate for Trunk Line "B." He reports Roy, POB, has been very sick man but is improving now. Sorry to hear that, Roy, and hope you have a speedy recovery. UHT is keeping about a dozen schedules. EHW reports the Southeast Nebraska gang going strong. EKK is assistant state Emergency Control Station and this emergency net is really doing things. UDH has been doing a lot of rag chewing on all bands. WKP reports Southeast Radio Club held picnic for months of Aug., Sept. and Oct. At each picnic portable rigs were in operation on both 56 and 1.75 Mc. The club has motorized its tape code machine. The First District Emergency Net is going fine; most of the gang in the net are members of the Club and are getting their crystal as fast as possible so as to be on the same frequency. At the September 25th meeting 9ANY of Lincoln gave a very instructive and interesting

talk on portable transmitters. The club was saddened by the sudden passing of the little son of Wilford Polling (9WUD). The Southeast Nebraska Radio Club had a picnic at Big Lake, Mo., Sunday Oct. 16th. A most enjoyable time was had by all. RUJ installed a rotary beam for 14-Mc. 'phone. SUS moved his transmitter from the cob-shed to the basement. VOI of Nemaha is now located at Pocatello, Idaho. ZGX, AFH, WKP, IVW and UZX enjoyed a short visit with BCX at Mound City, Mo., Oct. 16th. ZGX is using T-125 final on 1.75 and 28 Mc. with pair of TZ-40 Class B Modulators. HIJ and GIR of Peru, Nebr. are new hams and are busy getting their rigs on the air. ZFC has been busy getting things packed up to move to a new QTH in Omaha. FAM as the old rig tuned up for the season and Trunk Line "L" seems to be shaping up in good time. We have good connection to T.H. and P.I. FFF expects to do more radioing next month. YDZ reports for the gang around the northeast part of the state; he also made application for O.R.S. WGL has been working plenty of DX on 28-Mc. 'phone and 14-Mc. c.w. OPP, back on leave from Nevada, visited YDZ. VQO rebuilt modulator for zero bias. BZR bought an SW-3. ZPW is on 1.75-Mc. 'phone in early morning. CIR is accumulating parts for 28- and 14-Mc. 'phone. QQJ is going well. QWU-QWW-QQJ and YDZ are trying for 56 Mc.

Traffic: W9BNT 637 (WLU 303) DI 23 KPA 61 UHT 65 EHW 15 FAM 19 SDL 4 EKK 17 UDH 18 ZFC 153.

WEST GULF DIVISION

NORTHERN TEXAS—SCM, Lee Hughes, W5DXA—DNE has rig working OK on 3.5 Mc. FMZ has new Challenger. BKH reports GFL, GEH, HJN, AAO, CKN, FYI, AUL and BKH active in Abilene N.C.R. Unit. SP was in Los Angeles at death of his Mother. QA had lightning pay him a visit after cautioning others to avoid same! GJW is new O.R.S. and reports Wichita Falls N.C.R. unit getting on 2096 kc. for drills. CHJ is now using 250 watts to a pair of TZ40's. ECE reports GDK and HKD students in John Tarleton College. EYZ has a pair of '46's in new final. AZB is new O.R.S. FAJ is lining up some schedules. FZJ is active as O.B.S. CIN got hatched! FNP and HFN are new A.A.R.S. NW is papa of new boy—Congrats, Soupy. HFH is the new station of the 1st Bn. Hq. Btry. & Ct. 133 F. A., Tex. N. G., Fort Worth; FOR and GKG are operators; usual operating frequencies are 1918- and 14210-cc. 'phone and 3.5- and 7-Mc. c.w.; 56- and 28-Mc. 'phone rig are also available; give 'em a buzz. North Texas Net Members: 5EOE, BKH, FMZ, CDU, GJW, FRE, EZY, DNE, DXA and AZB; Net Freq: 3657 kc.

Traffic: W5EOE 250 CDU 106 DXA 65 CVA 39 DNE 33 FMZ 23 BKH 21 GJW 16 HFN 15 CHJ 14 ECE-BAM-EZY 5 AZB 4.

OKLAHOMA—SCM, Carter L. Simpson, W5CEZ—5CEZ invested in a new mill. Mert of FSK is being transferred to N. C. as soon as he gets out of hospital. Luck, OM! GFT is assigned A.A.R.S. call WLJE as one of the Okla. N.C.S. DTU spent an enjoyable period in Colo., New Mex., and Texas. HFW is a new station on the traffic reporting list. FRB visited the S.C.M. and N.C.R. Unit 5 while on vacation. CEB with GVV, FJ, GFT and FRB were on visit at Ponca City. EMD is still Oklahoma's chief Cipher Buster. GZR joined the A.A.R.S. BQA is working some nice DX on 14 Mc. GAQ resigned as N.C.S. of the Okla. 'Phone Net. EST has been out of town but is back ready for active season. EGQ is erecting a new "Bow and Arrow" beam antenna getting ready for the DX contest. HFE is a new ham in Oklahoma City, running 300 watts to a 100TH.

Traffic: W5CEZ 338 (WLJC 18 HESB-HE82 27) FSK 78 GFT 71 FOM 50 YJ 47 (WLGJO 21) EGP 41 (WLLJL 23) DTU 41 HFW 31 DAK 27 FRB 25 CEB 18 EMD 13 GZR 8 BJG 6 EXZ 5 BQA 3 GAQ 2.

SOUTHERN TEXAS—SCM, Dave H. Calk, W5BHO—5OW leads in traffic this month. MN has nine schedules every morning. FZD is QRL at the Univ. of Texas but keeps one schedule daily. DWN has two regular Corps Area net periods daily and schedules HDN at a C.C.C. station. CEK, operating portable at Harding, keeps daily schedule with AMZ, his dad. EWZ worked CM2BH for country number 24. GQK is rebuilding rig. FMV is going on 'phone. FYE are "FISH" at St. Marys Univ. FBN is a Freshman at Texas A. & M. HDK needs Asia for 28-Mc. W.A.C. EUL has an 8JK beam squitter. FYP built 56-Mc. receiver and is getting ready for DX with 6L6 crystal osc. ENX put up

new skywire for 7 Mc. FWE keeps the club rig, DIG on the air. GQV works at KLUF by day and operates on 28 Mc. by night. CDD is still trying to work 56 Mc. BVE is operator on big boat at sea. 9RYQ is a Seaman. OV built fine receiver. BTK rebuilt his shack and keeps the storm net going nicely. BEH worked all districts with a 6L6 crystal osc. HDY works 14 Mc. BKW works 3.9-Mc. 'phone and is President of the Houston Amateur Radio Club. BRC is back on 3.9-Mc. 'phone at his Houston QTH. CVQ carries a 7-Mc. portable in his car and can be heard or worked every night he is away from home. CFX and DRA visited the S.C.M. CFX operates on 3.9-Mc. 'phone. GBY has new QTH, Fort Sam Houston.

Traffic: W5OW 1418 MN 311 CVQ 91 DLZ 54 FZD 35 DWN 24.

NEW MEXICO—SCM, Joseph M. Eldodt, W5CGJ.

Traffic: W5ZM 1 (WLJG 37) ENI 46.

DELTA DIVISION

ARKANSAS—SCM, H. E. Velte, W5ABI—Thanks to GNV for the news in this report: GSY is working DX on 28 Mc. GJL worked Sweetwater, Texas (about 800 miles), with 2 watts input to a modulated oscillator in 1.75-Mc. 'phone. GSC is building a new shack in his back yard. GNV got Class A, O.B.S. appointment and is rebuilding for all bands. GYR with the help of HDC is rapidly completing his new 300-watt rig for 1.75, 28 and 7 Mc. GLZ is moving to the best location in town, the 5th floor of a flour mill with the whole roof for skywires. GVJ is going to school in Miss. HDC is getting out like ADJ's kw. with his B linear '03A on 1.75-Mc. 'phone. WK is building an all-band c.w. rig in addition to his 'phone layout for work with the A.A.R.S. HHZ is a "rural ham" and is building a small 'phone rig to work on 6 volt power. DZK is reworking his speech equipment for his 700-watt 'phone. HCP, a new ham at Paragould, works out FB on 7 Mc. with a pair of '10's in final. HFP, also a new ham there, is planning new rig. BJR has new portable emergency 'phone rig. ELP plans to go to school in Chicago in December; he will keep in touch with home via 14-Mc. 'phone through GNV. HBP has new 14-Mc. squirter. HAE is still "going to town" on 7 Mc. HGE took Class B at L.R. FGS is op. at KASP in L.R. GHJ won a 100TH at the Moarky Hamfest in Poplar Bluff, Mo. RW, after being off the air for five years, is getting back on with an all-band c.w. rig. QI is on 1.75-Mc. 'phone after pounding brass for so many years. GIC is op at KLCN in Blytheville and can be heard from GNV regularly as he is staying with him. GED has 40 watts on 1.75 Mc. and is heard mostly carrying on with the "Hoodlem" network. ABI has low power 1.75-Mc. 'phone rig using 6A7 with 3 watts input. GUG does wonders with 10 watts on 1.75-Mc. 'phone. HDR is putting out an FB sig with his 7-Mc. oscillator. BMI is building a portable c.w. rig to use at the L.R. police station when he's off duty. HAT is another member of the "Hoodlem" network and puts out a nice signal on 1.75 Mc. GTN, our "charred boy" ham at Hot Springs, took his Class B at L.R.; he puts out a nice signal on 3.5 Mc. DNX had a nice local Hamfest in shack with WIES, A. A. Hebert, as guest. GRL took Class A in L.R.; he has a nice signal on 1.75 Mc. GQG's 7 watt battery 'phone has already worked a couple of W6's this season! FKT haunts the ether late at night on 1.75 Mc. ATTENTION FELLOWS: W5GNV at Blytheville is trying to get some activity organization in the state. A comparison of this column with those of some of the other states will show how we need it. All fellows interested please get in touch with 5GNV and he will be glad to contact you on any workable band, 'phone or c.w., to talk the thing over and to plan a program for organization. All you fellows who have wondered what has happened to ARK in QST please get in touch with GNV, 1034 Main St., Blytheville, AND WE WILL GET SOMETHING STARTED!!! Hams attending the 5th meeting of the Moarky Radio Club at Poplar Bluff, Mo., were W5GNV, HDC, GYR, BJR, HPC, DZK, GEJ and RW. We thank you P.B. gang for a swell time.

Traffic: W5DNX 16.

LOUISIANA—SCM, Eugene H. Treadaway, W5DKR—R.M.'s: 5BN, 5DWW, P.A.M.'s: 5ADJ, 5GDU, E.C.: 5DAQ, O.O.: 5FBX. ACA finds time for O.R.S. job. FVD is back at Louisiana Tech trying to get the bugs out of HGT. DRR of Pine Bluff, Arkansas, is operating portable from Camp Beauregard. GUX plans on adding another '04A to his final for a full kw on 'phone and c.w. FSI has started on a new 200 watt 28-Mc. 'phone rig. HGT is station call of the

Tech Radio Club, a new and active outfit in our Section: CXH has a 200 watt job perking FB on 56-Mc. 'phone in our Crescent City; KC is our section's leading DX man. DWW is doing his part as R.M. for N. Louisiana. HCX is a sea-going ham these days. AOX is cutting his rig down to his own size. FPO lost his complete station in a recent fire. Our regrets, OM. Newly elected officers of New Orleans Radio Club: DXK Pres.; EBB Vice Pres.; S. Goldman Sect.-Treas.; EVS Activities Mgr. The club celebrated installation of officers with a banquet that was attended by all members and the Ladies Auxiliary of N.O.R.C. FXX deserves a big hand for the swell job he has done to originate traffic that will do a big job in keeping the old Section out in front. YU is station call of Tulane Radio Club. 9ZNT operates 7 and 14 Mc. from Barksdale Field. ECH is active on 14 Mc. with P.P. T55's. GTI, BRR, EVZ and FUM are doing their stuff in Baton Rouge. HHI, HHV and BSR are active stations in Lake Charles. 3ERE was visitor in New Orleans. HCX is working on his rig. DIQ and FWU report from Algiers. ADJ is out and at 'em on 1.75-Mc. 'phone. DAQ has things well in hand as Emergency Coördinator. DKR likes new signal shifter. HCO is increasing power. CXQ does his bit of DXing. BYX has T55 final. CEW is after DX. GMF is burning up 28-Mc. 'phone. GUK is building receiver. CJO and GND like the FB7 receiver. JW and GKJ were in a motorcycle accident and were done up some. FHH likes turning the dials of his HRO. BLQ has FB rig on 1.75-Mc. 'phone. HHT works 1.75-Mc. 'phone with low power. GIA is building a 28-Mc. rig. HCY has pair of T40's in final. CIQ is heard every Friday at 11:30 p.m. on 7 Mc. putting out his O.B.S. WIQP, none other than OM Reinartz, was in New Orleans and gave the N.O.R.C. members and the New Orleans hams a real treat by setting up a swell rig and talking on same and answering questions. DGB is receiving a flock of good looking DX cards. BN is handling traffic FB. GPS' tens are doing a nice job. FZA is proud owner of a commercial First ticket. MH has self-excited rig. QJ operates WUKM, the National Guard Station in New Orleans. 6BC is now in N.O. GMR is very active on 28-Mc. 'phone. ACY likes high power. Fellows! Please help our section by reporting your station activities each month on the 16th. 73.

Traffic: W5BN 1090 DKR 508 FXX 234 GUK 181 AOX 84 FPO 50 EDY 46 FMO 18 GIA 8 DNW 10 CXH 15 KC-GDU 3.

TENNESSEE—SCM, W. H. Walker, W4DWS—R.M.'s: 4PL, 4CXY. Our thanks to B. G. (Larry) Smith, W4DEP, for the splendid services he has given us as S.C.M. during the past two years. Good luck, Larry, and best wishes from the entire state. We only hope that we shall be able to duplicate his record of service. Our thanks, also, to all of you who have seen fit to honor us with the office. We pledge to you our very best efforts. The Tenn. Traffic Net got off to a swell start with old reliable PL and DEP controlling. Other stations on the net include AYW, BQK, RO, ERN, ETD, FX, CXY, 8LVU, 4VK and DWS. 2HCO also meets with us from time to time and helps with N. Y. traffic. Our Net Control Station for A.A.R.S. is DEP. We are glad to see CXY and FX back on the net in Knoxville. The Nashville Club has resumed its bi-weekly meetings after the summer vacation. The Nashville Emergency Net is under process of organization; it is sponsored by the club and its object will be to prepare the local men for emergency work. DFB has done some nice work in organizing the A.E.C. DDJ has been working on a rotary beam for 14 Mc. DLK has moved but will soon be back on 14-Mc. 'phone. BAF returned to 7 Mc. after a sojourn on 14 Mc. AEE reports good work progressing on A.A.R.S. 'phone net on 3.9 Mc. DDF and FMP are still trying to put that rig on c.w. BM can be heard on 14-Mc. 'phone. EFP is engineer at WSIX. Glad to hear AYE back. EYV at the airport is N.C.R. control here, we enjoyed the QSO with Luther. We thoroughly enjoyed the visit of our Communications Manager. He was honored at a banquet attended by many hams including PL and others from Chattanooga, Memphis and other cities. His speech was broadcast. We sincerely appreciate these visits from our Headquarters. FMJ is at the Univ. of Cincinnati. PL mailed us five traffic reports. Thanks, Benton. Our new O.R.S. in Memphis, FDT, reports putting message on land line and getting his answer. Nice work, Harvey. Thanks to all for reporting, and to those who didn't get the address it's 301 Bosobel, Nashville. 73.

Traffic: W4PL 1466 AYW 112 FDT 94 DWS 59 DEP 147 ETD 41 BQK 18 RO 17 ERN 15 VK 6.

DECIBEL METERS BY

Larger dial opening
gives more light
on scale

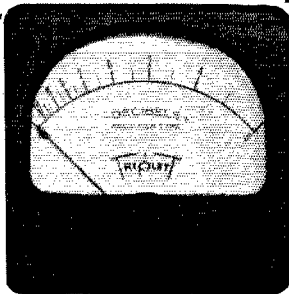

- ★ 3" and 4" Sizes Stocked
- ★ Other Sizes Available
- ★ Round or Square
- ★ Attractively Priced

MODEL 327-A DECIBEL METER

3" instrument in New Style Molded Case. **\$12.00**

Standard range reads up 6 and down 10 decibels, zero decibel at 1.73 volts, 500 ohm line, 6 milliwatts, standard damping furnished unless highly damped is specified.

ALSO 4" MODELS

- Model 321 — 3" Round..... \$12.00
- Model 421 — 4" Square..... \$13.17

DECIBEL METER KIT — Model 150 Kit complete with Decibel Meter, necessary multipliers, switch and other accessories..... **\$20.00**

— The Triplet Electrical Instrument Company —
— 2512 Harmon Drive Bluffton, Ohio —

LEARN CODE RIGHT

Always ready — no weather interference — beats having someone send you. Speed range 5 to 40 W.P.M. Radio or Morse.

- STANDARD with 10 tapes and book of instructions..... \$20.25
- JUNIOR with 5 tapes and book of instructions (not rented)..... \$12.00
- Complete oscillator equipment less battery, \$6.50

RENTAL Standard with 10 tapes and book of instructions \$3.00 first month, \$2.25 each additional month.

With transformer and tube socket 25¢ per month more. With key and head phones 50¢ per month extra. \$10 deposit or business references required.

Write for details today

INSTRUCTOGRAPH COMPANY

Dept. Q-12, 912 Lakeside Place, Chicago, Illinois

Representatives for Canada:

Radio College of Canada, 863 Bay Street, Toronto



NEW HOLDER DESIGN

15 SECONDS TO
INSTALL CRYSTAL

For All Bands
GREATER STABILITY

Plugs in 5 prong tube socket
Beautiful Appearance

MODEL AH HOLDER \$1.00 At your dealer or direct

HIPOWER LOW DRIFT CRYSTALS:
within 10 kc. or Choice of stock

AH-10, 1700-3500 Kc. bands \$2.35

AH-10, 7000-7300 " bands 3.90

WRITE FOR NEW LITERATURE

Hipower "Low Drift" Broadcast and Commercial Crystals Are Approved by F.C.C.

Hipower Crystal Co., 2035 Charleston St., Chicago

(Continued from page 90)

W8DZC-8	Elmira Amateur Radio Association ²²	79-AC-1	995
W5WG-5	Louisiana Tech Radio Club ²⁴	75-A-3	936
W4DJT-4	Southside Amateur Radio Association ²⁵	58-C-1	927
W4CUE-4	Birmingham Amateur Radio Club ²⁶	88-C-1	824
W1TA-1	Nashua Mike and Key Club ²⁷	70-A-2	810
W4NC-4	Winston-Salem Amateur Radio Club, Inc. ²⁸	90-B-1	810
W8ICS-8	The South Cleveland Radio Club ²⁹	73-A-3	810
W2AHC-2	Northern Nassau Wireless Association ³⁰	58-A-3	801
W4DUG-4	Tampa Amateur Radio Club ³¹	60-A-1	801
W9V SX-9	Hamfesters Radio Club ³²	85-B-1	792
W4GBU-4	Chattanooga Amateur Radio Club ³³	53-A-1	783
W9OKY-9	Pike's Peak Amateur Radio Association ³⁴	54-A-1	783
W8UK-8	South Hills Brass Pounders and Modulators Radio Club ³⁵	57-A-1	729
W8MMN-8	Aerial Radio Club ³⁶	46-B-1	720
W3AAF-8	Bluefield Amateur Radio Club ³⁷	72-B-1	702
W1BKQ-1	Worcester Radio Association ³⁸	53-A-1	693
W1DJC-1	Manchester Radio Club ³⁹	44-A-1	684
W8KYA-8	East Boroughs Radio Club ⁴⁰	71-AB-1	648
W2DVC-2	Schenectady Amateur Radio Association ⁴¹	35-B-2	642
W8ID-8	The Radio Frequency Club ⁴²	65-B-1	636
W8NLG-8	Detroit Amateur Radio Association ⁴³	41-A-1	587
W6ANU-6	Helix Amateur Radio Club ⁴⁴	115-B-2	564 rt
W9CJC-9	Black Hills Amateur Radio Club ⁴⁵	42-A-2	558
VE2IO	Montreal Amateur Radio Club ⁴⁶	28-A-1	549
W6ETB-6	Ogden Amateur Radio Operators Club ⁴⁷	76-AB-1	507
W8HXT-8	Ludington Amateur Radio Club ⁴⁸	32-A-1	504
W6BAM-6	Orange County Amateur Radio Club ⁴⁹	54-B-1	498
W3ZL-3	Delaware Valley Radio Association of Trenton, N.J. ⁵⁰	80-B-1	480
VE1MK	Halifax Amateur Radio Club ⁵¹	34-A-1	477
W3FBL-3	Richmond Short Wave Club ⁵²	28-A-1	459
W9ZOD-9	Central Colorado Radio Association ⁵³	32-A-1	459
W4EG-4	Raleigh Amateur Radio Club ⁵⁴	35-A-1	450
W9WWB-9	The San Isabel Amateur Radio Association ⁵⁵B-1	444
W8DSU-8	Finger Lakes Transmitting Society ⁵⁶	54-B-1	432
W8RDA-8	Steubenville Transmitting Society ⁵⁷	48-A-1	408
W6NJQ-6	San Joaquin Valley Radio Club ⁵⁸	46-A-3	354 RT
W3EEL-3	Baltimore Mike and Key Club ⁵⁹	29-A-1	351
VE3GJ	North Riverdale Radio Club ⁶⁰	33-B-1	348
W3DGM-3	Chester Radio Club ⁶¹	19-A-1	342
W7BL-7	Butte Amateur Radio Club ⁶²	32-C-1	330
W8PZE-8	Fostoria Wireless Association ⁶³	21-A-1	324
W7DB-7	Radio Club of Tacoma, Inc. ⁶⁴	34-A-2	313 Rt
W1AWY-1	Queen City Radio Club ⁶⁵	15-A-1	297
W6AME-6	Nevada County Radio Club ⁶⁶	22-A-1	297
W8NUP-8	Greater Cincinnati Amateur Radio Association ⁶⁷	33-A-2	297
W2GTW-2	Delaware Valley Brasspounders Association ⁶⁸	11-A-1	288
W9BIN-9	Starved Rock Radio Club ⁶⁹	25-AB-1	285
VE4AAW	Saskatoon Amateur Radio Club ⁷⁰	18-A-1	252
W8HKT-8	Twin Cities Radio Council ⁷¹	19-B-1	246
W9PAT-9	Minneapolis Radio Club ⁷²	34-AB-2	243
W6OOF-6	Porterville Union High School and Junior College Radio Club ⁷³	19-A-1	234
W9ZHR-9	Hamfesters Radio Club ⁷⁴	19-A-1	234
W6OJW-6	Oakland Radio Club ⁷⁵	10-A-1	207

**"Put Your Signal Where You Want It When
You Want It There"**

FEATURES OF THE 1939 SIGNAL SQUIRTER

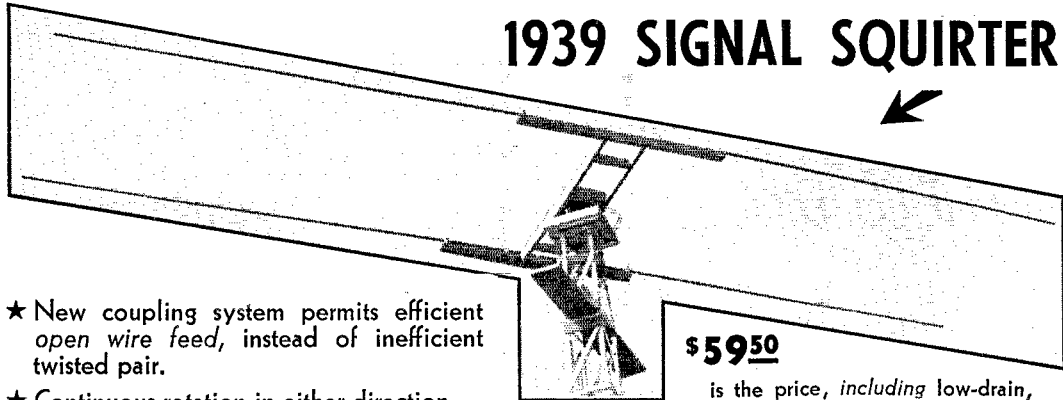

- ★ New coupling system permits efficient open wire feed, instead of inefficient twisted pair.
- ★ Continuous rotation in either direction.
- ★ Sturdy, simple, ingenious rotating mechanism.
- ★ "Inductostub" — the marvelous, new coupling device.
- ★ Self-supporting radiating elements.
- ★ Greater transmission gain.
- ★ Easy tuning.
- ★ Direction indicator.

\$5950

is the price, including low-drain, non-interference producing motors. Illustration above from un-retouched photo. • Ten meter kit for \$49.50. • Separate components also available. At these low prices, must be factory-direct proposition. Write now for full dope.

**WRITE
RIGHT
AWAY!**

MIMS RADIO COMPANY

M. P. MIMS—W58DB, P. O. Box 504, Texarkana, Ark.

RADIO COURSES

RADIO OPERATING: Prepare for Gov't License Exam. •
RADIO SERVICING: Including Short Wave • AMATEUR
CODE • ELECTRONICS • TELEVISION

Day and Evening classes—Booklet upon request

NEW YORK YMCA SCHOOLS

4 West 63rd Street, New York City

The New TURNER Model 99 Dynamic Microphone

**Gives You Dependable Performance
Regardless of Climate or Temperature**

Indoors or Out!

MODEL 99 gives you sure-fire operation under even toughest conditions. Crisp reproduction, no low frequency boom. The 99 has trustworthy response range, 60 to 9000 cycles; high level, -57 DB. Not sensitive to mechanical shock, or affected by dampness or salt air. Cable connector insures quick easy cable changes. Saddle is adjustable. Available in all impedances. **\$29.50** LIST HIGH IMPEDANCE

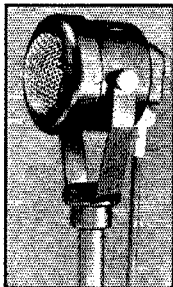

Weights 2½ lbs. Professional style. Write for free literature now!

THE TURNER CO.
CEDAR RAPIDS, IOWA
U. S. A.

**MODEL 99 — EX-
PENSIVE LOOKS
AT LOW COST**

Furnished in rich, durable gunmetal. Decidedly semi-directional, reducing feedback problems. 8 ft. cable included.

BE *Santa Claus* TO YOUR FRIENDS . . .



QST can help you with your Christmas list. Each year an increasing number of individuals finds it to be the ideal gift. A subscription present is unique, too. It serves as a monthly reminder of your thoughtfulness. A yearly subscription, including League membership, costs only \$2.50, little enough for the ones you have in mind. And — we'll send an appropriate gift-card conveying your Christmas Greetings at the proper time.

*A Monthly Reminder of Your
Thoughtfulness and Good Judgment*

QST

38 La Salle Road West Hartford, Conn.

THE RADIO AMATEUR'S Library

For some time our advertising in *QST* has carried a by-line reading "Number in the Series entitled Radio Amateur's Library." Many requests have been received for copies of this list and now we present it in *QST* in its complete form — to give a comprehensive picture of our publishing services to the amateur.

No.	Title	Price
1.	<i>QST</i>	\$2.50 per year*
2.	List of Stations	Pre-wr Out of Print
3.	Map of Member Stations	Pre-wr Out of Print
4.	Operating an Amateur Radio Station (Formerly called Rules & Regulations of Communications Dept.)	Free to members; to others 10c
5.	The Story of The A.R.R.L.	Out of Print See No. 13
6.	The Radio Amateur's Handbook	\$1.00**
7.	The Log	35c each; 3 for \$1.00
8.	How to Become a Radio Amateur	25c
9.	The Radio Amateur's License Manual	25c
10.	Hints & Kinks for the Radio Amateur	50c
11.	Lightning Calculators:	
a.	Radio (Type A)	\$1.00
b.	Ohm's Law (Type B)	1.00
c.	Wire Data (Type C)	50c
d.	Decibel (Type D)	50c
e.	Parallel Resistance — Series Capacity (Type E)	50c
f.	Resistance Calculator (Type F)	50c
12.	Amateur Radio Map of the World	1.25
13.	Two Hundred Meters and Down: The Story of Amateur Radio	1.00
14.	Building an Amateur Radiotelephone Transmitter	25c

*In the United States and Possessions and Canada,
Other Countries \$3.00 per year.

**Postpaid in Continental U.S.A. — \$1.25, postpaid,
elsewhere.

**THE AMERICAN
RADIO RELAY LEAGUE, INC.**
West Hartford, Connecticut

W8INE-8	Boys' Club of St. Marys Amate teur Radio Society *	13-A-1	198
W6PTX-6	San Mateo High School Radio Club *	10-A-1	162
W8IBU-8	Trico Radio Club *	15-A-1	153
W5SP-5	Abilene Amateur Radio Club *	16-B-1	132
W9VLO-9	Goshen Amateur Radio Club *	23-B-1	96 RT
W1ALO-1	Rockomeka Amateur Radio Club *	25-C-1	75
W1AQ-1	Associated Radio Amateurs of Southern New England *	6-A-1	54
W1CBA-1	Connecticut Brass Pounders Association *	4-A-1	36

Club operators: 1 W0BLL, W9BPN, W9DJG, W9DZU,
W9EKY, W9FYZ, W9KEH, W9DZG, W9NDE, W9PCE,
W9FXN, W9FCQ, W9RVN, W9RYV, W9RXT, W9THB,
W9WCM, W9YZX, W9ZLV, W9ZLV, W9ZLV, W9ZLV,
W9ZEN, W9ZKT, * W2AEB, W2AHX, W2AIV, W2BZJ,
W2CGH, W2CYS, W2FQK, W2FRC, W2FZY, W2GAK,
W2GUM, W2HEM, W2HFU, W2HTZ, W2IKL, W2KZW,
W2LDL, W2ZC, W1KVV, Walter Hampton, Walter Reynolds,
Edson Stanford, Ollie Talman, Russell Tully, * W3AIF,
W3AKB, W3AOL, W3AOB, W3BIV, W3CKJ, W3DGG,
W3DFU, W3EDC, W3EAW, W3EZH, W3ERE, W3ETM,
W3DMF, W3GUB, W3GUD, W3GRY, W3IU, W3PG, W3QV,
John Evans, W3GYV, W3QP, * VE3MY, VE3WL, VE3WA,
VE3KD, VE3ABY, VE3ZY, VE3ZO, VE3YE, * W9HHB,
W9HBL, W9YZ, W9GCU, W9GR, W9RER, W9UJ, W9EJL,
W9ZP, * W8OIA, W8OJ, W8UW, W8KBB, W8DGG, W8LL,
* W8AU, W8ADZ, W8BWX, W8CTX, W8QCH, W8RJX,
W8GWZ, W8QXA, W8QXE, W8MJH, W8QJH, W8LDZ,
W8DNE, W8MKA, * W9M2C, W9TGR, W9LIP, W9SRB,
W9RJE, W9RIS, W9NII, W9VJC, W9WOK, * W1AAJ,
W1BNS, W1GAE, W1FSV, W1GAN, W1GFW, W1GRU, W1LIS,
W1KYV, W1AZX, W1AGV, W1AGW, W1AGU, W1LIS,
W1IBH, W1IYB, W1JLN, W1KUH, W1APA, W1KAB,
W1LGN, W1LIG, Ed Faber, S. Hewitt, * W8KG, W8BDG,
W8CQJ, W8OQJ, W8QYR, W8BZL, W8CJL, W8RPH, W8PVU,
W8LHU, * W8MR, W8BHA, W8MIO, W8MAG, W8NSC,
W8LDB, W8MBC, W8OKI, W8KXK, W8VU, W8LUV,
W8OLC, W8LID, * W8OMM, W8KPN, W8MDU, W8GVT,
W8FVJ, W8MVK, W8YGC, * VE3KM, VE3AOH, VE3OJ,
VE3ADJ, VE3IA, VE3ANA, VE3CJ, VE3AFA, VE3AEM,
VE3MZ, VE3AEZ, VE3AEC, VE3DJJ, * W9IBD, W9PKO,
W9URU, W9ZGF, W9FUZ, W9YCL, W9ZGL, W9JL,
W9ZGM, W9ZGL, W9ZGM, W9ZGM, W9ZGM, W9ZGM,
W3FBT, W3GFC, W3BYW, W3GFK, W3AIB, W3AMP,
W3EDF, W3ENZ, W3GCU, W3FNU, W3HCL, W3AWH,
W3GHS, W3GDU, W3CFB, W3QEO, W3GWZ, W8LFM, Lois
Chunko, * W1AVJ, W1BTT, W1GKE, W1HOV, W1IUV,
W1AWU, W1BBA, W1JCA, W1JJD, W1LNL, * W5ERS,
W5EDQ, W5EMA, W5EFW, W5WFE, W5ZLN, W5GLO,
W5GHE, W5AXA, W5ETO, W5VQ, W5FWZ, W5ESV,
W5BRX, W5GQJ, W5EQG, W5BSK, Tom Finn, G. R. Morrow,
J. H. Douglas, * W9KA, W9CY, W9JO, W9PAE, W9PNB,
W9NST, W9CJP, W9MUM, W9YZL, * W2ABS, * W3ATE,
W3BZC, W3DYI, W3CMT, W3CMT, W3CMT, W3CMT,
W3BZC, W3DYI, W3CMT, W3CMT, W3CMT, W3CMT,
W2CUB, W2ERU, W3AC, W2GKM, * W9NJV, W9NZP,
W9W8S, W9MYG, W9RBO, W9KYY, W9UJM, W9JDP,
W9POS, W9QZO, W9YNP, W9JTZ, B. Ivers, Cooper, Grant,
* W8BXC, W8LHV, W8GUL, W8AWH, W8NXY, W8OYZ,
W8DZE, W8MKS, W8ALB, W8MFL, W8EAL, W8OQJ,
W8QBF, W8OJL, W8OMM, W8KPN, W8LKG, W8MOH,
W8MWO, W8H8X, * W8BKZ, W8OUU, W8NOU, W8NKE,
W8DVB, W8ECP, W8OVL, W8CVH, W8LFU, W8NDE,
W8PDH, W8EWW, * W4AKA, W4OCB, W4EHL, W4EPX,
W1HQQ, Bill Myers, Dutch van Hynning, Joe Dean, * W9FEO,
W9GEM, W9ELM, W9ELM, W9ELM, W9ELM, W9ELM,
W9QDT, W9HEE, W9RLB, W9PCH, W9LWJ, W9WMK,
W9ZTO, W9BVC, * W9LTC, * W9AZL, W9UL, W9LVA,
W9EME, W9SHW, W9BTD, W9ARA, W9AYG, ex-W9ADC,
* W8ADM, W8PPY, W8MKM, W8NEL, W8EOL, W8MBW,
W8SAX, W8PL, W4AM, W4FHQ, W4CBA, W4AIB,
W4VDK, W4PL, W4WZ, W4DVE, * W5CHE, W5GJ,
W8RZF, W8AYD, W8M2C, W8PVG, W8AVD, W8DZC,
W8OZY, Charles Cooper, LeRoy Hartman, Joseph Berry, Lew
Roy, * W5BMR, W5BQD, W5BYU, W5CTU, W5CMQ,
W5EB, W5GCS, W5FVD, W5GCM, W5WG, * W4DJJ,
W4CSZ, W4DQT, W4ZL, W4CPD, W4OVE, W4EJN, Marvin
Rutherford, Clark Fisher, * W4ECP, W4APT, W4ERX,
W4BLI, W4EYV, W4AAQ, W4FB, W4EPP, W4ATD,
W4FKG, * W1AFD, W1BHH, W1GEY, W1GHT, W1HQE,
W1HTO, W1KKQ, W1KLD, W1KYV, W1TA, * W4CTP,
W4DWB, W4OFG, W4CKJ, W4WX, W4CXE, W4BOH,
W4ABT, W4AIF, W4CFR, W4RA, * W8ICB, W8LXJ,
W8H8H, W8RFB, W8RFB, W8RFB, W8RFB, W8RFB,
W8PKN, W8OQV, W8MXI, * W2AHC, W2AOL, W2AYJ,
W2AZS, W2DUA, W2DXO, W2DJV, W2DJA, ex-W2DPQ,
W2FMC, W2EQJ, W2HYD, W2GZS, W2HYJ, * W4AJX,
W4DCZ, W4DRX, W4EFK, W4EGL, W4EUP, W4DIN,
W4DYM, W4ALF, W4EGL, * W8MEQ, W8EJD, W8LXJ,
W8YXZ, W8LUS, W8TAL, W8EJ, W8GFS, W9QYJ, * W9LFE,
W9LLT, W9EHC, W9FXQ, W9KJK, W9YAE, W9HHD,
W9JWC, W9OAR, W9ZIZ, W9TFT, * W8QAN, W8JX,
W8CKO, W8XP, W8FCO, W8OKF, W8GJM, W8JAX,
W8LDE, W8AIG, Kelly, Stoner, * W8OYT, W8MNM, W8PIG,
W8DNZ, W8EML, W8CAE, W8EML, W8EML, W8LBB,
W8WA, W8NXI, W8NYX, * W3AAE, W8MCT, W8EWM,
W8OFE, W8OHW, W8NAU, W8KCE, W8FCO, W8MOP,
* W1FJC, W1IYZ, W1KJY, W1DDK, W1DIE, W1CFQ,
W1HOR, W1JNA, * W1DJC, W1BEO, W1FSP, W1BAX,
W1HZK, * W8PDT, W8HGG, W8KYA, W8KTA, W8BSN,
W8RPT, W8RPT, W8RPT, W8RPT, W8RPT, W8RPT,
Calvin, one, * W2DVC, W2DHR, W2EHL, W2ACB, W2GYV,
* W8HJZ, W8CAR, W8OSC, W8AEV, W8ENO, W8OSW,
W8ID, H. Cook, V. Miller, A. Hoffman, * W8AKN, W8FTV,
W8QGD, W8IXJ, * W6ANU, W6OAN, W6NBJ, W6BZR,
W6MCH, W6EML, W6BIG, W6HFF, W6EPP, W6M1Y,
W6JRM, W6QPE, W6FTT, W6HFF, W6GOC, W6OGB,
W6RNY, W6YXK, W6LTT, W6YKY, W6ADJ, * VE2IO,
VE2BK, * W6ETB, W6BLE, W6LLE, W6PFX, W6OKF,

Station Operating Supplies

Designed by A.R.R.L. Communications Department

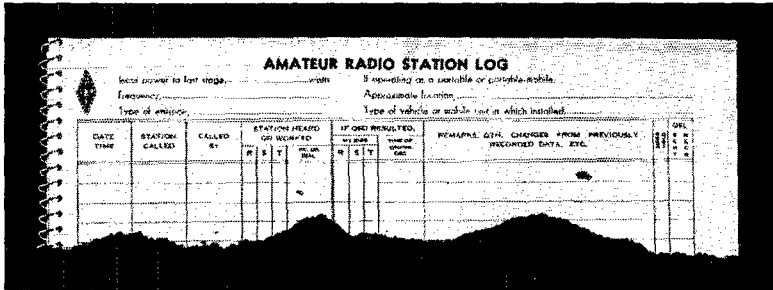

★
**THE
LOG
BOOK**
★

As can be seen in the illustration, the log page provides space for all facts pertaining to transmission and reception, and is equally as useful for portable or mobile operation as it is for fixed. The 38 log pages with an equal number of blank pages for notes, six pages of general log information (prefixes, etc.) and a sheet of graph paper are spiral bound, permitting the book to be folded back flat at any page, requiring only the page size of $8\frac{1}{2} \times 11$ on the operating table. In addition, a number sheet for traffic handlers is included with each book. The LOG BOOK sells for 35c per book or 3 books for \$1.

OFFICIAL RADIOGRAM PADS

The radiogram blank is now an entirely new form, designed by the Communications Department to comply with the new order of transmission. All blocks for fill-in are properly spaced for use in typewriter. It has a strikingly new heading that you will like. Radiogram blanks, $8\frac{1}{2} \times 7\frac{1}{4}$, lithographed in green ink, and padded 100 blanks to the pad, are now priced at 25c per pad, postpaid.

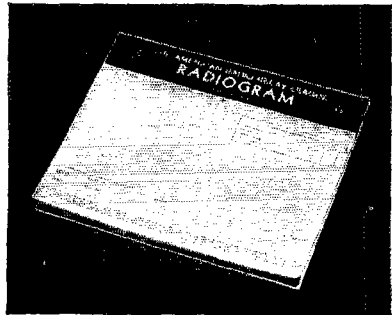

and MESSAGE DELIVERY CARDS

Radiogram delivery cards embody the same design as the radiogram blank and are

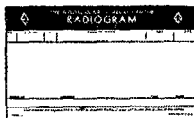

available in two forms — on stamped government postcard, 2c each; unstamped, 1c each.

AMERICAN RADIO RELAY LEAGUE, Inc.

West Hartford, Connecticut

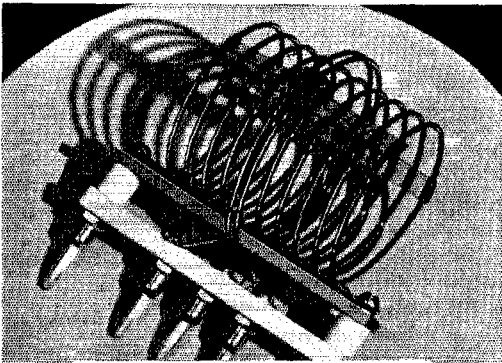

AS GOOD AS THEY LOOK!

A glance tells you that Type B and BL AIR INDUCTORS are neater in appearance, more compact, mechanically stronger than other coils. But the most important characteristic of all — higher efficiency — can be proved only by performance. Any claims we make for these unique 100 Watkers could never be so convincing as the results they give in operation.

That's why we say: Plug Type B or BL Coils into your rig — and "give it the works!" Put them to every test you can think of — in any 100 Watt application — under any condition — on any band! Then *YOU* be the judge!

Type BL (illustrated) is available center or end linked. Type B is the straight coil, center tapped. Both types from 5 to 160 meters; priced from \$1.00 to \$2.50 net

See them at your jobbers — or write for details

BARKER & WILLIAMSON

Radio Manufacturing Engineers • ARDMORE, PENNSYLVANIA

Piezo-Electric Crystals Exclusively

Quality crystals of all practical frequencies supplied SINCE 1925. Prices quoted upon receipt of your specifications.

Our Pledge: QUALITY FIRST

SCIENTIFIC RADIO SERVICE

"The Crystal Specialists Since 1925" University Park, Hyattsville, Md.

HOW TO LEARN CODE

Whether you wish to enter radio as a career or as a hobby, the All Electric Master Teleplex Code Teaching Machine will show you how. Teleplex records your sending in visible dots and dashes on a specially prepared waxed paper tape and then sends back to you at any speed you desire. It does not merely show you code. It is code. No experience needed.



While not designated as standard equipment, Teleplex is used at many U. S. Army Posts, Naval Training Stations as well as the American Telephone & Telegraph Co. Also by practically every private school in the U. S. teaching the code; and many foreign governments.

FREE BOOK We furnish you complete course, including practice messages, the All Electric Master Teleplex, plus a personal service on a MONEY BACK GUARANTEE. Low cost. Easy terms. Without obligation write for booklet "Q12."

TELEPLEX CO. 67-69 PARK PLACE NEW YORK, N. Y.

In Canada write: CANADIAN ELECTRONIC INST., TORONTO, ONT.

W6FYR, W6MDP, W6GRB, W6NLX, Lyle McLean, W7W8FQ, W8HXT, W6LWH, W6NSA, W6LYM, W6DHP, W6LQX, W6LXM, W6B1N, W6BAM, W7W3T, W3PBC, W3CCO, W3H3C, W3EKA, W3EUB, W7V1RQ, W6VFQ, W6LFB, VE1BJ, VE1MJ, VE1MZ, VE1FN, VE1EU, E. S. MacLaughlin, W7W3EVN, W3EFL, W3RZE, W3FJ, W3GKL, W3HBX, W7SZOD, W9OLL, W9YF, W9SNB, W9ECY, W9TWT, W9ODF, W9VTB, W9ZMI, W9TMA, W9WRO, W9WUG, W7W4EG, W4W9WB, W8DSU, W8NQC, W8LDA, W8OLN, W8RUR, W7WMTV, W6MYF, W6LFT, W6LTO, W6NDQ, W6KPT, W6BPU, W6BYG, W6MHL, W6JCB, W3W3E, W3CVA, W3EKZ, W3HHT, W3ESM, W7VEGR, W7W3BIL, W3BNS, W3CWQ, W3DRQ, W3DGM, W7WFRS, W7FKF, W7GJC, Stombath, E. Smith, Chilcote, Wiltmore, W7WEXG, W7EPP, W7GGW, W7GDW, W7GB, W7DE, W7BHS, W4WAWY, W7BLZ, W6AME, W7WNUF, W3ALW, W8NDN, W8ODE, W7W2TW, W2BLU, W2KFC, W8NV, GK, HD, HV, ES, NIC, JK, ABC, W7VEAMQ, VE4UD, VE4QP, VE4MB, W9ZHR, W7GTC, W8JZD, W8HKT, W8RAE, W8PYP, W9PAT, W8WZA, W8PYG, W6NPM, W6MU, W6OJW, W6ELW, W8IOH, W8IOF, W8LL, W8JZR, W8KXP, W8NDE, W8ODH, W8REE, W7WFBV, D. Bechtold, C. Deakin, B. Buchanan, L. Israel, L. Sablin, B. Runyon, W. Youngs, W8WSP, W9FEU, W9TRN, W9FRY, W9VLO, W9OEC, W9VNM, W9VG, W9SZU, W9NCT, W1ALO, W1TUT, W1BOY, W1CPV, W4CBU, W4GBS, W4ARP, W4EXK, W4EBX, W4DJJ, W1CTI, W1BCQ, W1KWR, W1EYF, Richards, Shepard, Hendrickson, Anderson, E. Root, Simpson, Walker, Foster, La Marche.

Individual and Group Scores

W2DKJ-2	W2IGK-ex-W2AHK-W2BKU- W2LAH-W2RSZ-W2DKJ...	226-A-2	1971 rt
W4ECI-4	W4ECI-W4EDR-W4FJA- Harrison.....	113-A-1	1521
W8CUG-8	W8CUG-W8CFR-W8NXD...	91-A-1	1485
W3BTQ-3	W3BTQ-W3EGV-W3GAU- W3DUK.....	77-A-1	1179
W1HDQ-1	W1EBO-W1GUY-W1HDQ...	86-A-1	1134
W9WYY-9	W9WYY-W9DTE-W9MCD...	72-A-1	1116
W1BB-1	W1BB-W1BDU-W1DRD- W1LBB-W1HFJ.....	86-A-1	1107
W9RRS-9	W9YFJ-W9RRS.....	68-A-1	1107
W6NIK-6	W6MTC-W6JQX-W6NYA- W6LXS-W6NIK.....	78-A-1	1071
W8BLT-8	W8HKS-W8FLA-W8AXN- W8AZT-W8MCX-W8OML- W8RZK-W8FDA-W8JHP- W8GSS-W8NBQ-W8BQ- W8BLT.....	85-AB-4	1014
W1EH-1	W1EH-W1JFN-W1JPE.....	64-A-1	1008
W5MS-5	W5MS-W5BZW-W5DVK.....	69-AB-1	888
W9FUH-9	W9FUH-W9PWU-W9AUJ...	77-A-1	873
W5FZD-5	W5FGB-W5CPB-W5FZD...	54-A-1	865
W5PMQ-5	W5EWB-W5GPJ-W5GRA- W5FMQ.....	75-A-1	810
W3GGC-3	W3FVC-W3FWE-W3GGC...	68-A-1	808
W2HLI-8	W2HLI-W2ECL-W2IZI- W2KRI.....	55-A-1	774
W8ASI-8	W8ASI-W8JKN.....	64-B-1	732
W5FEZ-5	W5FFG-W5CRT-W5FEZ...	81-B-1	720
W3EUQ-8	W8NTJ-W8PMY-W8NBD- W8KYW-W3EUQ.....	49-A-1	702
W8HMH-8	W8ALG-W8HMH-W8FIJ- W8LTI.....	38-A-1	693
W2HJM-2	W2GGS-W2GPY-W2HJM- W2JRF-W2KDK-W2KMN- W2KMT-W2KMS.....	41-A-1	675
W9LKO-9	W9LKO-W9OEQ-W5FAH- W9ZXE.....	41-A-1	675
W1NH-1	W1NH-Al Hunt.....	67-A-1	657
W5QL-5	W5ARB-W5CJS-W5EON- W5DDM-W5QL.....	68-B-1	654
W9AEM-9	W9AEM-W9FI-W9TEW- W9KRT-W9LBN-W9WNG- W9RHZ-W9YZN.....	47-A-1	639
W2ERJ-2	W2HGS-W2CLH-W2ERJ- W2FST-W2ECK.....	64-A-1	618
W6GTM-6	W6ISG-W6BBR-W6GTM...	40-A-1	594
W9TGB-9	W9QJK-W9BLV-W9TGB...	46-A-1	591
W9CEO-9	W9UQT-W9FLH-W9BPU- W9EAF-W9CEO.....	40-A-1	585
VE1BC	VE1BV-VE1KY-VE1MF- VE1BC-Dave Freeman...	31-A-1	576
W3FEW-3	W3FEW-W3FUT-W3FVJ- W3GOB.....	37-A-1	576
W8DDC-8	W8DDC-W8DNX-W8BBW...	48-B-1	544
W9KXJ-9	W9KXJ-W9SFZ.....	38-A-1	540
W2GBY-2	W2GBY-W2FSQ.....	39-A-1	531
W6LAI-6	W6LAI.....	41-A-1	531
W1BDI-1	W1UE-W1AFB-W1BDI- W1TDT.....	26-A-1	513

Where to buy it

A directory of suppliers who carry in stock the products of these dependable manufacturers.



ALBANY, N. Y. Uncle Dave's Radio Shack 356 Broadway
ATLANTA, GEORGIA 265 Peachtree Street
 Wholesale Radio Service Co., Inc.
BOSTON, MASS. Radio Shack 46 Brattle Street
BOSTON, MASS. 110 Federal Street
 Wholesale Radio Service Company, Inc.
BRONX, N. Y. 542 East Fordham Rd.
 Wholesale Radio Service Company, Inc.
BUTLER, MISSOURI 211-215 N. Main Street
 Henry Radio Shop
CHICAGO, ILL. 833 W. Jackson Blvd.
 Allied Radio Corp.
CHICAGO, ILL. 901-911 W. Jackson Blvd.
 Wholesale Radio Service Company, Inc.
COLUMBUS, OHIO 203 N. Fourth St.
 Bell Radio Parts Co.
DETROIT, MICH. 325 E. Jefferson Ave.
 Radio Specialties Co.
DETROIT, MICHIGAN 11800 Woodward Ave.
 Radio Specialties Co.
HARTFORD, CONNECTICUT 227 Asylum Street
 Radio Inspection Service Company
HOUSTON, TEXAS 625 East 14th Street
 R. C. Hall & L. F. Hall
JAMAICA, L. I. 90-08 166th Street
 Wholesale Radio Service Company, Inc.
KANSAS CITY, MO. 1012 McGee Street
 Burstein-Applebee Company
NEW ORLEANS, LA. 902 Poydras Street
 Shuler Supply Company
NEW YORK, N. Y. Gross Radio, Inc. 51 Vesey St.
NEW YORK, N. Y. Harrison Radio Co. 12 West Broadway
NEW YORK, N. Y. 100 Sixth Ave.
 Wholesale Radio Service Co., Inc.
NEWARK, N. J. 219 Central Ave.
 Wholesale Radio Service Co., Inc.
OAKLAND, CAL. 2085 Broadway
 Offenbach Electric Co.
POTTSVILLE, PENN. E. Norwegian & George Sts.
 Jones Radio Company
READING, PENN. 404 Walnut St.
 George D. Barbey Company
READING, PENN. 104 North Ninth Street
 Jones Radio Company
SAN FRANCISCO, CAL. 1452 Market Street
 Offenbach Electric Company
SPRINGFIELD, MASS. T. F. Cushing 349 Worthington St.
WASHINGTON, D. C. 938 F Street, N. W.
 Sun Radio & Service Supply Co.

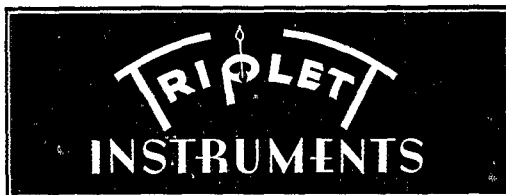

ALBANY, N. Y. Uncle Dave's Radio Shack 356 Broadway
ATLANTA, GEORGIA 69 Forsyth Street, N. W.
 Garvin Electric Company
ATLANTA, GEORGIA 265 Peachtree Street
 Wholesale Radio Service Company
BOSTON, MASS. Radio Shack 46 Brattle Street
BOSTON, MASS. 110 Federal Street
 Wholesale Radio Service Company, Inc.
BRONX, N. Y. 542 East Fordham Rd.
 Wholesale Radio Service Company, Inc.
BUTLER, MISSOURI 211-215 N. Main Street
 Henry Radio Shop
CHICAGO, ILLINOIS 833 W. Jackson Blvd.
 Allied Radio Corp.
CHICAGO, ILLINOIS 25 North Franklin Street
 Electric & Radio Supply Co., Inc.
CHICAGO, ILL. 901-911 W. Jackson Blvd.
 Wholesale Radio Service Company, Inc.
DALLAS, TEXAS 1905 Commerce Street
 Southwest Radio Supply
JAMAICA, L. I. 90-08 166th Street
 Wholesale Radio Service Company, Inc.
LITTLE ROCK, ARKANSAS 409 W. 3rd St.
 Beem Radio Company
MIAMI, FLORIDA 123 Second Street, N. E.
 Tropical Camera Stores, Inc.
MINNEAPOLIS, MINNESOTA 1124-26 Harmon Place
 Lew Bonn Company
MONTREAL, CANADA 285 Craig Street, West
 Canadian Electrical Supply Co., Ltd.
NEW ORLEANS, LA. 902 Poydras Street
 Shuler Supply Company
NEW YORK, N. Y. 100 Sixth Avenue
 Wholesale Radio Service Company
NEWARK, N. J. 219 Central Ave.
 Wholesale Radio Service Company
OAKLAND, CAL. 2085 Broadway
 Offenbach Electric Co.
POTTSVILLE, PENN. E. Norwegian & George Sts.
 Jones Radio Company
READING, PENN. George D. Barbey Co. 404 Walnut Street
READING, PENN. 104 North Ninth St
 Jones Radio Company
SAN FRANCISCO, CAL. 1452 Market Street
 Offenbach Electric Company
WASHINGTON, D. C. 938 F Street, N. W.
 Sun Radio & Service Supply Co.

The American Radio Relay League

AMATEUR

RADIO MAP

OF THE WORLD

★ On a sheet of heavy map paper 30 x 40 inches Rand, McNally, world's premier map-makers, have — to A.R.R.L. specifications — imprinted in six colors and black every single bit of map information useful to the radio amateur.

The special modified equidistant azimuthal projection permits great circle distance measurements in miles or kilometers accurate to better than 2%. Local time in all parts of the world is shown, as well as Greenwich corrections. The official I.A.R.U. WAC continental sub-divisions are given. Principal cities of the world are shown, including, in the U. S., all district inspection offices and examining points.

Perhaps most useful of all is — for the first time — a standard list of countries of the world, arranged on a basis of geographical and political divisions — clearly shown by color breakdown and the detailed reference index. There are 230 countries shown, 180 prefixes (the prefixes in large open red lettering that you can't miss). More than that, all known national districts and other sub-divisions are shown.

Entirely new in conception and design, large enough to be useful, complete in every detail — here is the map radio amateurs have been waiting for these many years. Make a place for it on your wall now — it'll be the most interesting object in the shack.

PRICE **\$1.25**
POSTPAID

**American
Radio Relay League**
West Hartford, Connecticut

W3ZD-3	W3ZD-W3EIS-W3FQB.....	33-A-1	513
W8HMJ-8	W8HMJ.....	27-A-1	513
W2ADW-2	W2ADW-W2JER-W8EAM- W2FCH-W2BFA-W2HNY- W2BIU.....	20-A-1	486
W5ABQ-5	W5ABQ.....	28-A-1	447
W9WNB-9	W9WNB-Eastman-Miller- Price-Boyd.....	42-B-1	444
W9WIC-9	W9WIC.....	43-A-1	432
W1CII-1	W1CII-W1AMS-Milton Howe	29-A-1	405
W8ELJ-8	W8LGB-W8QQZ-W8KHB- W8ELJ.....	65-B-1	390
W1KIK-1	W1AUN-W1LDI-W1KIK... ..	47-A-1	384 T
W9NQP-9	W9MUX-W9IYA-W9NQP... ..	36-B-1	354
W9WGP-9	W9ESM-W9QDO-W9CNT- W9ZBP-W9ZBO-Elmer Wright.....	22-A-1	351
VE3GZ	VE3PO-VE3QU-VE3DO- VE3GZ.....	20-A-1	333
W8QKW-8	W8GWH-W8HHQ-W8IMK- W8MEQ-W8PIK-W8QKW	24-A-1	324
W1APK-1	W1APK.....	16-A-1	306
VE2AP	VE2CU-VE2AP.....	20-B-1	288
W3EEQ-3	W3EEQ.....	14-A-1	279
VE2CO	VE2GE-VE2CX-VE2CO.....	23-A-1	252
VE2KH	VE2KH-VE2BV-VE2FG-VE2CD	14-A-1	234
W3GKI-3	W3GKP-W3HMX-W3GXI- W3EYX.....	10-A-1	225
W9RDK-9	W9RDK-W9SWZ-W9UPJ... ..	14-A-1	225
W3EQX-3	W3FGG-W3EQX.....	12-A-1	216
W8KZL-8	W8KZL.....	13-A-1	216
W6HIT-6	W6HIT.....	18-A-1	207
W8LYZ-8	W8LYZ-W8PYL-W8DNC- W8RIX-W8OYV-W8RQK- W8RQJ-J. Barnhart.....	12-A-1	207
W9QDL-9	W9AKY-W9AZN-W9EXH- W9HSE-W9QDL-W9ZWH- W9YEX-W9EWY-W9YUL- W9ZUM.....	20-A-1	207
W8MLM-8	W8MJV-W8MLM-W8JFF- W8NNJ-W8CPI.....	24-B-1	198
W4EPT-4	W4EPT.....	42-AC-1	151 RT
W9QJ1-5	W9QJ1-W5FER-W5NY-W5FQA	48-B-1	150 RT
W1AZW-1	W1AZW.....	10-A-1	135
W8QPS-2	W8QPS.....	25-A-1	132 RT
W1IWC-1	W1IWC.....	9-A-1	126
W9LLV-9	W9LLV.....	3-A-1	126
W1JBJ-1	W1JBJ.....	14-A-1	114 RT
W6CIS-6	W6CIS.....	26-A-1	111 RT
W2LAU-2	W2LAU-D. L. Brown.....	10-A-1	108
W8LO-1	W8LO.....	9-A-1	99
W4ESO-4	W4ESO.....	14-B-1	96 T
VE3ATI	VE3ATI-VE3ATC-VE3AWC.	7-A-1	90
W6OMH-6	W6OMH.....	8-A-1	90
W6PAF-6	W6PAF.....	22-A-1	90 RT
W8ACY-8	W8ACY.....	12-A-1	30 T
W9NYH-9	W9NYH.....	3-A-1	72
W9EFK-9	W9EFK-W9BFC.....	16-B-1	70 RT
VE4ABM	VE4ABM-VE4AF.....	5-A-1	63
VE4EA	VE4ADW-VE4ADD-VE4XF- VE4AEA-VE4EA-VE4HM- VE4LQ-VE4AH-VE4FR- VE4AQ-VE4BV-VE4VJ..	5-A-1	63
W5FZU-5	W5FZU-W5GQL.....	13-A-1	54
W9BEW-9	W9BEW-W9LCM-W9WXL- W9JWE-W9HNV-W9BKU- W9WUR.....	18-B-1	50
W8PK-8	W8PK.....	3-A-1	45
W2FU-1	W2FU.....	14-C-1	44 R
W6PNI-6	W6PNI.....	24-BC-1	41 RT
W8OPX-8	W8OPX-W8PMB-W8OYY... ..	6-B-1	36
W3BHE-3	W3BHE.....	5-B-1	30
W8OMM-8	W8OMM.....	1-A-1	9

Strays

VE5FB saws 4-prong tube bases in half with a large and a small prong on each half, then uses them in conjunction with tube sockets for meter and key plugs.

● RADIO OPERATOR'S COURSE ●

TELEGRAPHY
TELEPHONY
AVIATION
TELETYPE
TELEVISION
TRANS RADIO
PRESS

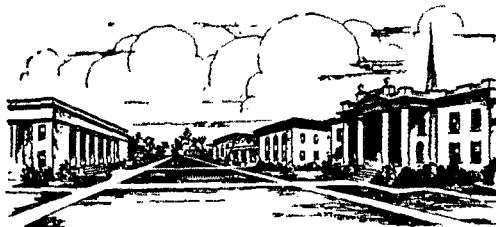

PRACTICAL
EXPERIENCE
STUDIO —
TRANSMITTER —
ANNOUNCING
TYPEWRITING

Port Arthur College advertises primarily to Radio Amateurs and the training is too technical for the average student who has not selected Radio as his life's work. The opportunities for positions and advancement are unlimited for men who are interested in Radio and who plan to make this their career and are willing to make the sacrifice and effort necessary to master the training. P. A. C. maintains strict collegiate rank — only high school or college graduates are eligible for enrollment.

If interested in details about Radio Course, write for bulletin R

PORT ARTHUR COLLEGE ■ **PORT ARTHUR (World-known port) TEXAS**

SICKLES COILS

SECURE A COPY OF OUR NO. 939
CATALOG FROM YOUR JOBBER

F. W. SICKLES COMPANY

300 Main Street

Springfield, Mass.

FTA CONSTRUCTED EQUIPMENT gives MAXIMUM RESULTS PER DOLLAR

Let us build your next piece of equipment. Complete laboratory and machine shop facilities. Write us your requirements today.

Speech and RF Units
Monitors and Compressors
Special units of all kinds.
Relays, etc.

Xmitter kits assembled
QST designs built up
Write for photos of our
work

FEIGNER TECHNICAL ASSOCIATES

525 Woodward Avenue 22 years in radio Detroit, Michigan

NO GUESSWORK

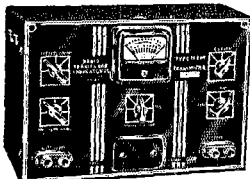

You don't have to guess at the performance of our units . . . simply WRITE for bulletins listing complete specifications on our new, APPROVED transmitters, etc. . . . SEE them at your local jobber . . .

RADIO TRANSCEIVER LABS.

8627 115 Street · Richmond Hill, New York City
CABLE ADDRESS: "RATRALAB"



EXTRA! speed in mastering code. **EXTRA!** confidence in ability. **EXTRA!** accuracy in sending and receiving is guaranteed by this new recorded code course. Hear it at your dealer's or write

RALSTON RADIO CODE COURSE
5433 Willows Avenue Philadelphia, Pa.

FOR 10 AND 20 METERS

Vertical Steel Radiators

- FULLY TELESCOPING AND ADJUSTABLE
- QUICK, EASY TO INSTALL
- NO LONG PIPES TO HANDLE
- SIMPLY ERECT 6-FOOT UNIT AND EXTEND TO HEIGHT DESIRED
- SPECIAL DESIGN 25,000 VOLT INSULATOR SIMILAR TO 800-FOOT TOWER TYPE

Made of steel tubing in carefully designed sizes to permit telescoping to 6-ft. unit yet extending to any height up to 34 ft. for 20-meters. Six sections with 3-point locking joints, all heavily copper plated for minimum R.F. resistance.

10-Meter Radiator is of three sections, employing the famous Corulite Elements — extending to 17 feet. Ask your jobber or write direct.

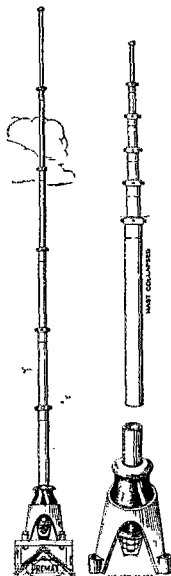

Premax Products

Division of Chisholm-Ruder Co., Inc.
3852 HIGHLAND — NIAGARA FALLS, N. Y.

SEND
FOR
SPECIAL
ANTENNA
BULLETIN

THE ALL BAND EXCITER

WITH THE BL-5G and BL-5P TUNERS

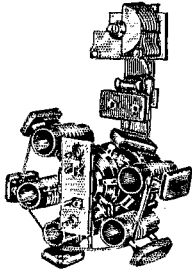

BL-56

At last a band switching all-band exciter which is simplicity itself and which really puts out. Using the BL-5G and BL-5P Tuners allows the construction of a rig which is truly versatile. Crystal control or E.C. oscillator on any band at the throw of switch — E.C. circuit with remarkable stability and a note which cannot be told from crystal —

jump from 5 to 160 at a moment's notice. Ask the Ham who owns one. Complete constructional details in July issue of QST.

PRESELECTION SIMPLIFIED

Here is your preselector in the simplest and most efficient form. The BL-5H Tuner forms the basis of a simple preselector which covers all the Ham bands from 10 up. Band switching and complete Ham band spread. Regenerative circuit gives exceptional image rejection. The whole Town's talking about the new BL-5 Amateur Tuner.

See July issue of QST for constructional details

BROWNING LABORATORIES

WINCHESTER, MASS.

Export Dept. 461-4th Av., New York, N. Y., U.S.A.

NEW!

GORDON HEAVY DUTY RF RELAY

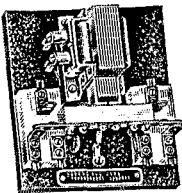

- Takes 1 Kw. Easily
- Husky 3/8" Silver Contacts
- 1/2" Contact Spacing
- Alsimag 196 RF Insulation

This sturdy RF relay is designed for Antenna Change-over, Multi-band Transmitter Tank Switching and 60 cycle Power Switching. No chatter. For 110 volt A.C. Very reasonably priced at \$9 net.

See Your Jobber or Write for Details

GORDON HAND WHEELS

FOUR SIZES

(3 1/4", 2 3/4", 1 3/4", 1 1/4" dia.)

Here is a sweet line of tuning controls. Be sure to see all sizes and combinations at your jobber's. Available with chrome metal pointers, with scales or dial plates. Give your panels that professional touch by standardizing on GORDON Hand Wheels and Name Plates.

★ Write for listing of 126 GORDON Name Plates. Also data on World DX Clock and other GORDON accessories.

WRITE DEPT. Q FOR GORDON CATALOG



GORDON SPECIALTIES COMPANY

1104 SOUTH WABASH AVENUE CHICAGO, ILLINOIS

A.R.R.L. QSL Bureau

FOR the convenience of its members, the League maintains a QSL-card forwarding system which operates through volunteer "District QSL Managers" in each of the nine United States and five Canadian districts. In order to secure such foreign cards as may be received for you, send your district manager a standard No. 10 stamped envelope. If you have reason to expect a considerable number of cards, put on an extra stamp so that it has a total of six cents postage. Your own name and address go in the customary place on the face, and your station call should be printed prominently in the upper left-hand corner.

W1—J. T. Steiger, W1BGY, 35 Call Street, Willimansett, Mass.

W2—H. W. Yahnel, W2SN, Lake Ave., Helmetta, N. J.

W3—Barron P. Freeburger, W3DK, 435 5th St., N. E., Washington, D. C.

W4—G. W. Hoke, W4DYB, 328 Mell Ave., N. E., Atlanta, Ga.

W5—E. H. Treadaway, W5DKR, 2749 Myrtle St., New Orleans, La.

W6—Horace Greer, W6TI, 414 Fairmount Ave., Oakland, Calif.

W7—Frank E. Pratt, W7DXZ, 5023 So. Ferry St., Tacoma, Wash.

W8—F. W. Allen, W8GER, 324 Richmond Ave., Dayton, Ohio.

W9—Roy W. McCarty, W9KA, 11 South Michigan Ave., Villa Park, Ill.

VE1—J. E. Roue, VE1FB, 84 Spring Garden Rd., Halifax, N. S.

VE2—C. W. Skarstedt, VE2DR, 236 Elm Ave., Westmount, P. Q.

VE3—Bert Knowles, VE3QB, Lanark, Ont.

VE4—George Behrends, VE4RO, 186 Oakdean Blvd., St. James, Winnipeg, Manitoba.

VE5—H. R. Hough, VE5HR, 1785 First St., Victoria, B. C.

K4—F. McCown, K4RJ, Family Court 7, San-turce, Puerto Rico.

K5—Norman F. Miller, K5AF, 15th Air Base Squadron, Albrook Field, Canal Zone.

K6—James F. Pa, K6LBH, 1416D Lunalilo St., Honolulu, T. H.

K7—Dean Williams, K7ELM, Box 2373, Juneau, Alaska.

KA—George L. Rickard, KA1GR, P. O. Box 849, Manila, P. I.



● Make your Present 'Phone Fidelity with the new acoustical earcaps. Have them for your Christmas present. The new earcaps can be delivered for any one of the following makes of 'phones: Baldwin, Ambassador, Brandes, Cannonball, Globe, Kellogg, Murdock, Radioear, Solid, Trimm Feather-weight, Professional and Western Electric. Send for illustrated circular.

PAUL JARNAK, *Inventor and Manufacturer*
69 West 33rd Street Dept. Q-12 New York, N. Y.

HAM-ADS

(1) Advertising shall pertain to radio and shall be of nature of interest to radio amateurs or experimenters in their pursuit of the art.

(2) No display of any character will be accepted, nor can any special typographical arrangement, such as all or part capital letters be used which would tend to make one advertisement stand out from the others.

(3) The Ham-Ad rate is 15c per word, except as noted in paragraph (6) below.

(4) Remittance in full must accompany copy. No cash or contract discount or agency commission will be allowed.

(5) Closing date for Ham-Ads is the 25th of the second month preceding publication date.

(6) A special rate of 7c per word will apply to advertising which, in our judgment, is obviously non-commercial in nature and is placed and signed by a member of the American Radio Relay League. Thus, advertising of bona fide surplus equipment owned, used and for sale by an individual or apparatus offered for exchange or advertising inquiring for special equipment, if by a member of the American Radio Relay League takes the 7c rate. An attempt to deal in apparatus in quantity for profit, even if by an individual, is commercial and all advertising by him takes the 15c rate. Provisions of paragraphs (1), (2), (4) and (5) apply to all advertising in this column regardless of which rate may apply.

Having made no investigation of the advertisers in the classified columns, the publishers of QST are unable to vouch for their integrity or for the grade or character of the products advertised.

QUARTZ—direct importers from Brazil of best quality pure quartz suitable for making piezo-electric crystals.

Diamond Drill Carbon Co., 719 World Bldg., New York City.

RADIO engineering, broadcasting, aviation and police radio, servicing, marine and Morse telegraphy taught thoroughly. All expenses low. Catalog free. Dodge's institute, Byrd St., Valparaiso, Ind.

USED receivers, Bargains. Cash only. No trades. Price list 3¢. W8DQ, Wilmington, Del.

QSL'S, all colors, cartoons, snappy service. Write for free samples today. W1BEF, 16 Stockbridge Ave., Lowell, Mass.

CALLBOOKS—Winter edition now on sale containing complete up-to-date list of radio hams throughout entire world. Also world prefix map, press schedules and new time conversion chart. Single copies \$1.25. Canada and foreign \$1.35. Radio Amateur Call Book, 610 S. Dearborn, Chicago.

QSL'S, Cuts, Cartoons. Free samples. Theodore Porcher, 7708 Navahoe, Philadelphia, Penn.

CRYSTALS: X-cut, 1750-2000, 3500-4000, ± five kilocycles, \$1.50; spot frequency, \$2.50. Three small, 80 meter blanks, including carborundum, \$1.20. William Threm, W8FN, 3071 Moosewood St., Cincinnati, Ohio.

QSL'S, SWL's: one color 45¢, two color 60¢ hundred, postpaid. Samples. W1FTM, 268 Piedmont, Waterbury, Conn.

TELECHART'S copyrighted method will help you learn code. Easy and fast. Only 50¢ complete. Telechart, Box 25-Q, Knoxville, Tenn.

QSL'S, SWL's, 100—3 color—75¢. Lapco, 344 W. 39th, Indianapolis, Ind.

1000 watt G.E. transformers 1100-2200-4400 volts each side c.t. Guaranteed. \$13.50. Dawson, 6740 Woodward, Detroit, Mich.

LISTEN for high frequency broadcast station W9XA, 26,450 kilocycles, Kansas City.

QSL'S, Free samples. Printer, Corwith, Iowa.

BASSETT buys for cash Collins, Harvey, Temco transmitters; National, Hammarlund, RME receivers; etc. Send data and desired price to W9ZDO.

FREE catalog, Y-cut crystals, 75¢. Other cuts reasonable. Also commercial crystals. Faberadio, Batavia, Ill.

QSL'S, samples, Meador, Box 1534, Savannah, Ga.

CRYSTALS, mounted, 80-160 \$1.25, V-cut 40 \$2.25. R9 Crystals, 338 Murray Ave., Arnold, Pa.

PHONE amateurs attention. Douglas Universal modulation transformers. Match all tubes. One year guarantee. 50 watts audio, \$4.95 pair; 100 watts audio, \$7.75 pair. Postpaid in U. S. Write W1XIR, Rice Lake, Wis.

SELL: 110 good QST's, \$10. Jack Trainor, Santa Fe, N. Mex.

RADIO hams make the best salesmen for shortwave diathermy units to physicians. Large commissions paid. Leading mfr., established 1879. McIntosh Electrical Corp., 225 N. California Ave., Chicago.

BARGAINS: ham receivers, new Leicas, Contax, Robot cameras and supplies. Springfield Radio Co., 397 Dwight St., Springfield, Mass.

BRAND new Jewell meters. Any kind, any range. W2CXY, Hillside, N. J.

PHONOCRAFT automatic record changer—10" & 12" records intermixed. Metal tarnished; works excellently. Cost \$50.; sell \$14. Ship C.O.D., examination privilege. Craig, 728 W. Market, Bethlehem, Penn.

QSL40 chassis, 75 cents; kits. W9LXQ, Box 1244, Indianapolis, Ind.

WANTED: new or used 803. W9UXD.

SWAP or sell few 1 mfd. 5600 volt oil condensers. W9UXD.

QSL'S, QSL's that bring returns. Samples? W8DED, Holland, Mich.

BILLEY crystals? Patronize W8DED.

QST, "Radio" or any yearly magazine subscriptions accepted, appreciated by W8DED.

SELL: pair 150Ts, sockets, and Thordardson 5 v. transformer. all for \$22. Universal velocity mike and desk stand, \$12. Johnson #630 160 meter tank and 200D70 variable condenser, \$10. Other bargains. Write W9EKD, 5927 Primrose, Indianapolis, Ind.

SELLING out. Stamp for list of used parts. W9LVO, 415 Oak St., Brazil, Ind.

QSL'S, samples free. W8RCT, 76 Colorado, Highland Park, Mich.

SELL: TRF receiver complete, \$15. W2VGV.

ROLLEIFLEX and case to trade for receiver—NC81X preferred. W60YX, 1650 W. 36 St., Los Angeles.

SACRIFICE: complete 400 watt fone, T125 final, 203Z modulators, racks and panels, 8 meters, used 44 hours. Hammarlund receiver. \$240. W2FRZ.

SELL at big discount all new parts partially completed transmitter, 53—parallel RK23s—P.P. T-55s, including tubes, power supplies. Cabinet job. Bruton, 4 Washington Circle, Alexandria, Va. Telephone Temple 3209-J.

SELL: 9 tube s.s. super—original QST type—20, 40, 80 coils, tubes and power supply, \$15. W6AAE.

SELL: 18 watt modulator—57, 56, 57, PP2A3, 80—chassis mounted with power supply & tubes, \$15. W6AAE.

BRAZILIAN quartz—importers of highest quality tested quartz suitable for making piezo-electric crystals. Donald M. Murray, 18 Pearl St., N. Y.

WANT VM5. W9ADG.

SELL Collins 32-A complete: aircraft key, coils, 20, 40, 80 meters, 80 Biley crystal, antenna coupling unit, extras. Best offer. Lieut. Bermingham, U. S. Naval Academy, Annapolis, Md.

QSL'S, Finest cards, lowest prices. Maleco, 1805, St. Johns Place, Brooklyn, N. Y.

FEATURING Thordardson multi-band transmitters. Loughnane & Co., Decatur, Ill.

CRYSTALS: X-cut 1" sq. 80—160, \$1.40; mounted, \$2.25; 40, \$2.50; mounted, \$3.25. ± 3 kilocycles. Guaranteed the best. The Ransom Lab., N. Syracuse, N. Y.

SKY champion, brand new, swap, \$42.50. Muralt, 321 N. Russell, Portland, Ore.

CRYSTALS: 80 meter AT cuts, drift coefficient better than four cycles, within five kilocycles, \$2.25. Holders, \$1. Ham Crystals, 1104 Lincoln Place, Brooklyn, New York.

PERFEX—vibrator converter, slightly used, 110 d.c./110 60 cycle a.c., 150 watts, filtered, fused, black crackle, \$18. ICS radio course 34 booklets, \$5. W1HRZ.

COLLINS 30 FXC with new 10Z r.f. unit, as new. 312 watts. Complete with mt. mike. Priced \$725. Write for details submitting best offer. W8PTN, 400 South Blvd., W., Pontiac, Mich.

SWAP: two good used RCA-801's for TZ-40. W4DSO.

TELEPLEX #2, tapes for sale, \$9. Ralston, 255 Pomeroy, Pittsfield, Mass.

CRYSTALS: airmailed, 180—80M Lodrift, 40M X, \$1.85; 40M Lodrift, \$2.75. Holders, \$1. Bugs, \$4.50. C.O.D.'s accepted. Air-wound coils—all types—write. C-W Mfg. Co., 1170 Esperanza St., Los Angeles.

QSL'S, W8BZK, Newark, Ohio.

T9 crystals: Eidson features high performance crystals rather than mass production and high pressure advertising. A trial order will convince any skepticals; remember—satisfaction guaranteed. Fracture resisting high activity type X-cut 40 and 80 meter bands, \$1.60, 7301-7500 k.c. range, \$2. postpaid. C.O.D.'s accepted. Improved T9 ceramic holder, \$1. Low drift 7500-10,000 k.c. commercial crystals available—inquire. High accuracy calibration assured. Sold by these reputable dealers: Pembleton Labs., Ft. Wayne, Ind.; Frank Anzalone, 375 W. 46th St., N.Y.C.; The Hargis Co., Austin, Texas; Casa Edison, Havana, Cuba; Van Radio, 464 E. 117th, No. 7, Cleveland, Ohio; Henry Radio Shop, Butler, Mo.; Espy's, 2223 State St., New Orleans, La.; or Eidson's, Temple, Texas.

QSL'S printed for the ham, by a ham—W2AEY.

GENERAL Electric 24/750 volt 200 mill dynamotors unused, \$15. Westinghouse 27.5/350 volt, \$10. 500 watt 6-15 volt d.c. with propellers, \$3. 500 watt 500 cycle with exciters, \$8. Henry Kiessle, 215 Hart Blvd., Staten Island, N. Y.

QSL'S, SWL'S—Original, outstandingly different. Fritz's, 455 Mason, Joliet, Ill.

CRYSTALS: mounted—160, 80, \$1.25; 40M, \$1.60. C.O.D.'s accepted. Pacific Labs., 344 Fetterly Ave., Los Angeles, Calif.

QSL'S: high quality—100—50¢ postpaid. Samples. Howe Brothers, Wisner, Neb.

SELL: 200 watt phone-c.w. transmitter, \$125. Want candid camera. W2CIZ.

ROTARY beams—two or three element arrays complete or special heat treated tubing only. Write International Arrays, W8NMY.

INSTRUCTOGRAPH machine, twelve double American Morse tapes, key and sounder, instructions. All like new for \$15. Hoyt Ensign, Coldwater, Ohio.

NAMEPLATES: bakelite, engraved to order; prices reasonable. List upon request. A. L. Woody, 189-L. W. Madison St., Chicago.

OSCILLOGRAPH: DuMont—new 5" tube, cash or trade for receiver. Philip Towle, 404 E. Cass St., Albion, Mich.

SELL: 160 phone 50 watt, \$35. R. Stimpson, 615 Alabama Ave., S.E., Washington, D. C.

JUST what you need for that rotary. Complete worm drive units. Drive integral with beam head. Aluminum-manganese self-supporting tapered telescoping beam elements. Aim it with a synchronous Selsyn type direction indicator. Tilting heads. W8ML.

SELLING out: NC100X, \$80. Gross CP55 transmitter, factory-built, TZ20's final complete, \$55. Come get. W3FYW.

SELL complete station: RME9 and 250 watt transmitter. Extra equipment. Commercial appearance. Sacrifice. Greater N. Y. C. hams only. Phone evenings; Stillman 4-2153.

FOR sale: RME-69, \$100. R. Thayer, 720 Arbor St., Ann Arbor, Mich.

SELLING out complete 70 watter with 2 power supplies, \$25. S.S. superhet, \$15. 600 watt a.c. generator, \$15. W9TCC, Petersburg, Ill.

QSL'S—highest quality, lowest prices. Radio Headquarters, Ft. Wayne, Ind.

CRYSTALS: T9 X-cut, \$1.60. Holders, \$1. See Eidson's Ham-ad. Kelvin P8 multi-crystal holders. Takes eight crystals all bands, \$5.25. C.O.D.'s O.K. Prompt service from Van Radio, 464 E. 117th, No. 7, Cleveland, Ohio.

TWO RCA-803 pentodes, perfect, \$13.50 each with sockets. 100' Bassett BCF64, \$10. Hal Justice, Canton, N. C.

SX-17—bargain. W8ANT.

NEW RME-70's. W8ANT.

JOHNSON Q beams. W8ANT.

PREMAX rotary beams. W8ANT.

COMMUNICATION headquarters. Transmitters designed and built to order. Receivers serviced. All phases of high frequency communication. Write to Southern Ohio's only amateur owned amateur business. Jos. N. Davies, W8ANT, 2767 N. Bend Rd., Sta. A., Cincinnati, Ohio.

SLIGHTLY used instructograph. Furlow, Mt., Enterprise, Texas.

VIBRATOR power supplies complete, vibrator, OZ4, wired, \$3.25. W9HKR, Kokomo, Ind.

FOR sale: new RCA-872A's, \$9.50 each. 75 watt 10—20 xmitter, complete in 36" relay rack, Class B modulated, \$79.50 less crystal mike. 1 kw. xmitter, pair Eimac 250TH's final, Class B modulated, Eimac 150T's, high gain speech, 4000 volt plate transformers, Par-Met enclosed relay rack, at present on ten meters. Bargain at \$650. Underwood #5 typewriter, like new, \$29. Navy night and day glasses, like new—first \$10. 160 meter rig—210 P.F. final, Class B modulated with Breting 12 receiver, complete—\$110. W1DIK, 35 Whitaker Ave., Rumford, R. I.

AMPERITE ribbon microphones chromium model RAH, \$8. Turner crystal microphones, \$7. Public address amplifiers 6 volt d.c.—110 volt a.c. combination 15 watt output, with tubes, \$25. White Sound Service, 151 W. 63rd St., New York, N. Y.

WHEN buying amateur equipment whether you pay cash, trade in equipment, or buy on terms, it's to your advantage to write W9ARA. Write W9ARA for the newest equipment. W9ARA, Butler, Mo.

BARGAINS: reconditioned guaranteed communications receivers shipped on ten-day trial. Practically all models at big savings. Terms. List free. W9ARA.

HARVEY 80-T transmitter, \$99.; Collins 4A, \$39.; others. List free. W9ARA.

CODE machines rented. W9ARA.

1 kw. transmitter—commercially designed. Described March QST. Eimac 250T's final amplifier, B & W HDVL swinging link tank (replaces Johnson tank). Transmitter equal to any \$3,000 unit. Guaranteed perfect and new in every respect. Complete with tubes, \$1,500. W9AXH.

CHICAGO hams: Moving to coast—best offer takes 150 watt transmitter. Six foot relay rack. W9MHP, rear 2204 Cleveland Ave., Chicago.

TELEPLEXES, instructographs, omnigraphs, meters bought, sold. Ryan's, Hannibal, Mo.

SELL: practically new Sky Champion, \$38. Armin Meyer, Capital University, Columbus, Ohio.

RCA ACT-40 phone transmitter with tubes in metal rack with antenna tuning unit, \$145. Ideal for small municipal police transmitter. W9KJF.

RADIO

ENGINEERING, broadcasting, aviation and radio telegraphy and telephony, Morse telegraphy and railway accounting taught thoroughly. Engineering course of nine months' duration, equivalent to three years of college radio work. School established 1874. All expenses low. Catalog free. DODGE'S INSTITUTE, Day Street, Valparaiso, Indiana

VERTICAL RADIATORS

BEAM AND MOBILE ANTENNAS

The original self-supporting Vertical Radiator that stands up in all kinds of weather. Fully adjustable from 28 to 34 ft. Order Direct.

Type H F 20. 33-ft. Radiator. (20-40-80-160 Bands): \$19.50
Type H F 10. 16 ft. Radiator. (10-20-40-80 Bands): \$13.50

Remit with order or C. O. D. on receipt of \$5.00 deposit

ACE PRODUCTS CO.

2605 2nd Avenue, Seattle, Wash.

More PEP AT 56 MC.

Get the thrill of working 5 meters with a simple, easy to build crystal controlled transmitter. Your distributor



can show you how with a Biley HF-2 16 meter crystal unit. At all Biley Dealers for \$5.75.

BLILEY HF2 CRYSTALS

UNIDIRECTIONAL DYNAMIC D9T



← BACK—No Pickup
← FRONT—Full Coverage

VOLUME INCREASED by Reducing Feedback

D9T, List \$37.50, High Imp., 25' Cable
D9, List \$35.00, Low Imp., 25' Cable

Write for Catalogue No. 29

Manufacturers full line Dynamic, Crystal, and Carbon Microphones and Stands

AMERICAN MICROPHONE CO., INC.
1915 So. Western Ave. Los Angeles, California

Your Nearest Dealer Is Your Best Friend

Your nearest dealer is entitled to your patronage. You can trust him. He is equipped with a knowledge and understanding of amateur radio. He is your logical and safe source of advice and counsel on what equipment you should buy. His stock is complete. He can supply your needs without delay. His prices are fair and consistent with the high quality of the goods he carries. He is responsible to you and interested in you.

Patronize the dealer nearest you—You can have confidence in him

CHICAGO, ILLINOIS

Allied Radio Corporation
833 West Jackson Blvd.

Complete standard lines always in stock—W9IBC, W9DDM, W9GEZ

CHICAGO, ILLINOIS

Chicago Radio Apparatus Company
415 South Dearborn Street (Est. 1921)

W9RA and W9PST — Amateurs since 1909

CHICAGO, ILLINOIS

Wholesale Radio Service Company, Inc.
901-11 West Jackson Boulevard

"The World's Largest Radio Supply House"

DES MOINES, IOWA

Iowa Radio Corp.
1212 Grand Avenue

Complete amateur stock, W9OCG—W9EMS—W9KAY

DETROIT, MICHIGAN

Radio Specialties Company
325 E. Jefferson Avenue
Ham Supplies — National & Hammarlund Sets and Parts

KANSAS CITY, MISSOURI

Burstein-Applebee Company
1012-14 McGee Street
"Specialists" in supplies for the Amateur and Serviceman

KANSAS CITY, MISSOURI

Radiolab
1515 Grand Avenue
Amateur Headquarters in Kansas City

MILWAUKEE, WISCONSIN

Radio Parts Company, Inc.
538 West State Street
Complete stock Nationally Known products

MINNEAPOLIS, MINNESOTA

Lew Bonn Co.
1124-26 Harmon Place
W9BP—W9TLE—W9ZXV—W9DKL—W9VED

OAKLAND, CALIFORNIA

Offenbach Electric Company
2085 Broadway
"The House of a Million Radio Parts"

SAN FRANCISCO, CALIFORNIA

Offenbach Electric Company, Ltd.
1452 Market Street
"The House of a Million Radio Parts"

SEATTLE, WASHINGTON

Northern Radio Company
2208 Fourth Avenue
W7AWP and W7CR to serve you

ST. LOUIS, MISSOURI

Van Sickle Radio Company
1113 Pine Street
W90WD invites you to amateur headquarters in St. Louis

You Are Protected When You Buy From QST Advertisers

“Advertising for QST is accepted only from firms who, in the publisher’s opinion, are of established integrity and whose products secure the approval of the technical staff of the American Radio Relay League.”

Quoted from QST’s advertising rate card.

Every conceivable need of a radio amateur can be supplied by the advertisers in QST. And you will know the product has the approval of the League’s technical staff.

Index to Advertisers

Ace Products Company	104
American Microphone Company, Inc.	104
American Radio Institute	90
Amplex Engineering Company	82
Astatic Microphone Laboratory, Inc.	82
Barker & Willamson	98
Bliley Electric Company	56, 104
Browning Laboratories, Inc.	102
Brush Development Company, The	84, 86
Candler System Company	74
Capitol Radio Engineering Institute	80
Cardwell Manufacturing Corp., Allen D.	58
Centralab	59
Collins Radio Company	Cov. 2
Cornell-Dubilier Electric Corp.	67
Coto-Coil Company, Inc.	78
Delaware Radio Sales Company	87
Dodge’s Institute	104
Eitel-McCullough, Inc.	61
Feighner Technical Associates	101
Folster, H. J.	83
Gardiner-Levering Company	83
General Rotary Antenna Company	78
Gordon Specialties Company	102
Gross Radio, Inc.	87
Hallcrafters, Inc., The	1, 2
Hammarlund Manufacturing Company, Inc.	57, 62
Harvey Radio Company	96
Harvey Radio Laboratories	96
Heintz & Kaufman, Ltd.	91
Henry Radio Shop	83
Hipower Crystal Company	94
Hygrade Sylvania Corp.	70
Hytronic Laboratories	64
Instructograph Company	94
International Resistance Company	63
Jarnak, Paul	102
Johnson Company, E. F.	65
Kato Engineering Company	86
Ken-Rad Tube & Lamp Corp.	87
Kenyon Transformer Company, Inc.	7
Mallory & Company, Inc., P. R.	54
Massachusetts Radio School	87
Messner Manufacturing Company	69
Mims Radio Company	95
National Company, Inc.	Cov. 3, 53, 71
New York YMCA Schools	95
Newark Electric Company	79
Ohmite Manufacturing Company	72
Port Arthur College	101
Precision Apparatus Company	66
Precision Piezo Service	90
Premax Products	101
RCA Institutes, Inc.	83
RCA Manufacturing Company, Inc.	Cov. 4
Radio Mfg. Engineers, Inc.	107
Radio Shack, The	85
Radio Supply Company	96
Radio Transceiver Laboratories	101
Ralston Record Company	101
Raytheon Production Corp.	55
Scientific Radio Service	98
Sickles Company, F. W.	101
Simpson Electric Company	82
Solar Mfg. Corp.	90
Sun Radio Company	100
Taylor Tubes, Inc.	73
Teleplex Company	98
Terminal Radio Corp.	81, 97
Thordarson Electric Mfg. Company	75
Transducer Corp.	83
Triplet Electrical Instrument Co., Inc.	94
Turner Company, The	95
United Transformer Corp.	108
Utah Radio Products	77
Vibroplex Company, Inc., The	86
Wilson, Willard S.	87
Wincharger Corp.	91
Vaxley	54

THE NEW RME-70 RECEIVER

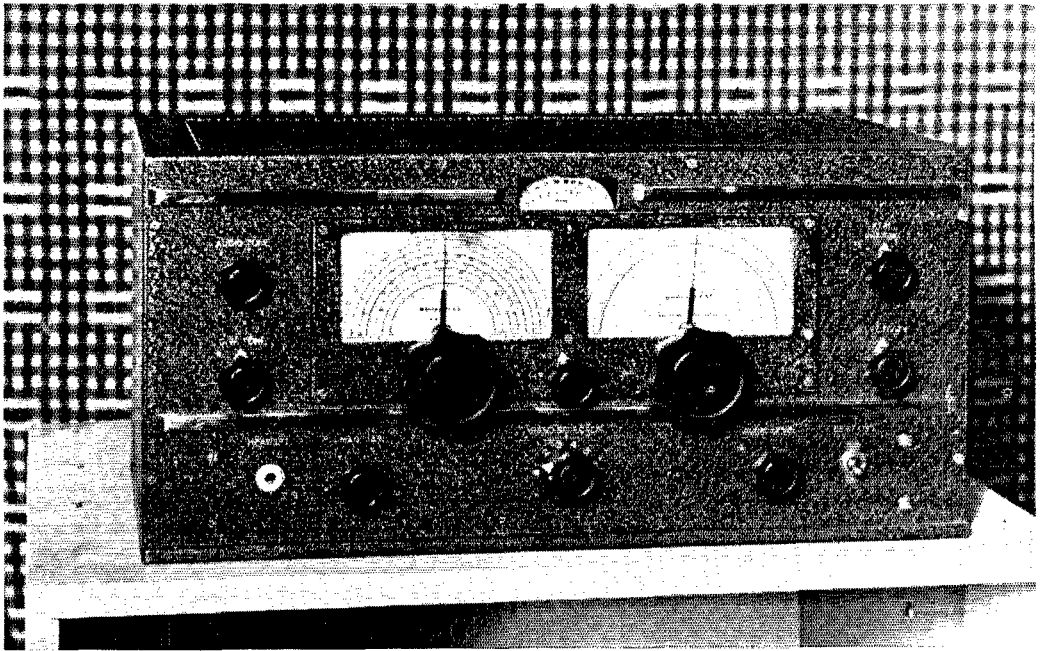

The DB-20-70

A two stage, three circuit, radio frequency amplifier unit covering the frequency range from 550 to 32,000 KC. in six bands. Designed to be used ahead of any good superheterodyne receiver to give added selectivity and considerable signal increase on all frequencies. The unit comes standard with antenna changeover switch incorporated, supplied with three tubes, and built-in power supply. It may be ordered equipped for any voltage or frequency, including battery or B-pack operation, either in black or gray crinkle finish.

The DB-20-70 matches in outward appearance the RME-70 series receiver, being provided with rectangular dial opening and chrome trim. The price remains identical to the standard DB-20 and is listed in the regular price sheet.

The Combination RME-70 and DB-20-70

In many instances the combination cabinet to house the receiver and preselector as one unit is desired. This arrangement has been made possible in the RME-70 series. Either gray or black crinkle finish with the fine appearance now available in this new series permits many stations to dress up modern and utilize the combination as introduced by the RME-70 and the DB-20-70.

Special literature is available for any of the separate units in addition to the combination. In the combination, the DB-20 is equipped with an antenna changeover switch. Literature will be gladly sent upon request.

The 510X-70

This unit was introduced by RME to popularize the five meter band and to give amateurs an opportunity to obtain exceptional results at moderate expenditure instead of buying a complete superheterodyne receiver for this purpose. This unit is to be used ahead of a good, stable, superheterodyne receiver to produce the best results. Transmitted signals to which the 510X is tuned should be crystal-controlled or reception is erratic and practically impossible.

The 510X-70 covers the range from 28 to 70 megacycles. It is a good image rejector in the ultra high frequency band. It is equipped with changeover switch, self contained power supply and built on cast aluminum frame to make the 510X a real five meter job. In outward appearance it matches the RME-70, being equipped with chrome trim. No change in cost over the regular 510X is listed in the price sheet.

THE RME-70 S. S. S. RECEIVER

In introducing the RME-70 series receiver no radically new instrument has been designed and built. Several features heretofore optional in the RME-69 series have been incorporated as standard in the RME-70. Relay control and break-in features are standard. An automatic noise suppressor is standard. Iron-core mica-trimmed transformers are standard.

A reduction in price is made possible through the elimination of all optional features, which are only available in the RME-69 series instrument. Only through standardization and concentration on this one model type has it been possible to lower the price of the new 70 and still keep the performance high.

The instrument comes standard with illuminated DB-R Meter, new automatic noise suppressor, resonator control, standard or special bandspread for requirements as desired, standard crystal control filter of the variable phasing type, headphone jack, and, of course, built on cast aluminum frame to insure high stability and fine operation at all times.

The RME-70 is available in cabinet model only, either gray or black crinkle finish. From input to output its performance will be a revelation to even the old timers. Pay your dealer a visit and check its operation.

RADIO MFG. ENGINEERS, INC.
ONE ELEVEN HARRISON STREET, PEORIA, ILLINOIS, U.S.A.

BELIEVE IT OR NOT

WITH APOLOGIES

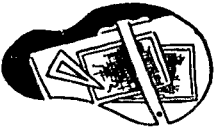

The unexcelled laboratory and engineering facilities at UTC bring some of the largest commercial organizations to us with their special transformer problems. Some of the more interesting units recently made by UTC for such organizations are almost in the "Believe it or not" class.



Television service represents an unprecedented problem in the wide range of frequencies which must be covered. UTC supplied transformers for one organization with a range of 30 cycles to 2 megacycles.



Innumerable hum problems are brought to UTC from remote amplifiers operating next to theatre dimmers to pre-amplifiers adjacent to power supplies. Every situation encountered was cured through the use of the LS-10X tri-alloy shielded input transformer.



Light weight is one of the specialties of the UTC design staff. A recent aircraft control filter incorporating three high Q coils and four condensers weighed approximately $5\frac{1}{2}$ ounces and occupied dimensions $1\frac{3}{8}'' \times 1\frac{1}{8}'' \times 2''$.

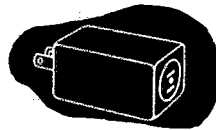

Manufacturers of low power lamp and electric razor equipment needed a step-down transformer to permit the operation of 110 V. units on 220 V. lines. Ordinary units were bulky. UTC developed an item with the transformer built into the line cord plug.

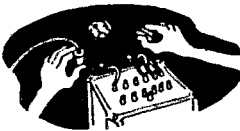

Speaking of high Q coils, obtaining a 1 mill henry coil with a high Q at 10 KC is rather simple. Making a 1 henry coil to operate at this frequency is another story. Through special design, a recent UTC coil for this service had an inductance of 1 henry and a Q of 90 at 10 KC. Corresponding design effects a Q of 200 at 1 KC.



For brain wave machines and similar applications, exceptionally low frequency response is required. For an application of this type, UTC recently developed a transformer down only 2 DB at .5 cycles with a phase shift of 6 degrees from 3 to 5000 cycles.

● The above examples are given primarily to indicate the trend and possibilities of advanced transformer design. If you have a special problem, write to the UTC engineering staff. Our standard products are described in the new compact PS-403 bulletin, now available at your distributor.

UNITED TRANSFORMER CORP.

72 SPRING STREET

NEW YORK, N. Y.

EXPORT DIVISION 100 VARICK STREET NEW YORK, N. Y. CABLES: "ARLAB"

★ QST ★

Index to Volume XXII—1938

AMATEUR RADIO STATIONS

The New PITC (Bellem).....	19, Jan.
W9AXH, Indianapolis, Ind.....	43, Mar.
W9FQU, Park Ridge, Ill.....	50, Apr.
A Visit to WIAW (Handy).....	10, Oct.

REGULATIONS AND LEGISLATION

Cairo (Budlong) Part I.....	11, Jan.
Part II.....	32, Feb.
The First Interamerican Radio Conference (Warner).....	9, Feb.
F.C.C. Disciplinary Actions... 66, May; 46, Aug.;	59, Sept.
The Battle of Cairo (Warner and Segal).....	9, July
F.C.C. Notes.....	22, Aug.
New Amateur Regulations Effective Decem- ber 1st.....	27, Nov.
We Have New Regulations (Warner).....	11, Dec.

ANTENNAS, FEEDERS AND MASTS

Directional Antennas with Closely-Spaced Elements (Kraus).....	21, Jan.
Inexpensive Coaxial R.F. Transmission Line (Smith).....	19, Feb.
Rhombic Antenna at HH4AS (Exp. Section) The HH4AS Rhombic Antenna (Exp. Section).....	50, Feb. 54, Mar.
A Continuously Rotatable 28-Mc. Beam (Neuenhaus and Schreiner).....	45, Mar.
Universal Antenna Coupler (Exp. Section).....	52, Mar.
Simple Directional Arrays Using Half-Wave Elements (Stavron).....	17, May
New Ideas in Rotatable Antenna Construction (Whitney and Whitney).....	20, May
A Tuned Loop for 80- and 160-meter Recep- tion (Tynes).....	10, Apr.
Information on Pulleys for Amateur Antenna Use (Exp. Section).....	42, Apr.
The Extended Double-Zepp Antenna (Ro- marder).....	12, June
A Ten-Meter Rotatable Alford Beam (Wal- lace).....	33, July
Which Directive System? (Romander).....	16, Aug.
A DeLuxe Rotary Antenna Structure (Trow- bridge).....	26, Sept.
A Simple Gear Drive for Rotary Antennas (Exp. Section).....	46, Sept.
Handy Kink for Tuning 6-meter Auto Antenna (Exp. Section).....	47, Sept.
Some Thoughts on Rotary Beam Antennas (Lynch).....	45, Oct.
Simplifying the Rotary Antenna Mechanism (Exp. Section).....	61, Oct.
Direction Indicators for Rotatable Antennas Let's Settle Those Antenna Questions (Ferrill) Speaking of Rotary Beams (G.G.).....	47, July 23, Nov. 55, Nov.

ARMY-AMATEUR RADIO SYSTEM

Around the Clock with WLM.....	36, Jan.
Transpacific Schedules.....	35, Feb.
Armistice Day Message Competition.....	35, Feb.
Speed Contest Results.....	34, Mar.
State Nets.....	51, May
Portable Sets.....	44, Apr.
First Corps Area.....	32, June
Third Corps Area.....	51, July
Second Corps Area.....	51, May
Fourth Corps Area.....	31, Aug.
Fifth Corps Area.....	33, Sept.
Sixth Corps Area.....	51, Oct.
Seventh Corps Area.....	46, Nov.

AWARDS

W9RSO Wins 1937 H.P.M. Award.....	29, June
WAC (Issuances, July-December, 1937).....	56, Mar.
1938 Paley Award Goes to W9MWC (C.B.D.).....	18, Aug.
WACC.....	56, Sept.

BEGINNERS

A Simple 110-Volt A.C.-D.C. Code-Practice Oscillator (Ferrill).....	34, Apr.
A Simple One-Tube Receiver (Ferrill).....	34, June
Modern Radio Course Resumes Over WIXAL	39, Nov.

BOOK REVIEWS

Radio Operators Manual (General Electric)...	102, May
Fundamentals of Radio (Terman).....	68, Apr.
How to Pass Radio License Examinations (Drew).....	96, June
Engineering Electronics (Fink).....	120, Nov.

COMMUNICATIONS DEPARTMENT

Emergency Operating Policies (F.E.H.).....	47, Jan.
A.R.R.L. Trunk Lines.....	49, Jan.
O.B.S.....	52, Jan.; 59, Mar.; 61, May; 50, June; 62, July; 60, Sept.; 72, Nov.
Trans-Pacific and Other DX Schedules.....	56, Feb.
Night Owl Net.....	57, Feb.
Election Results (S.C.M.s).....	60, Feb.; 58, Apr.;
	52, June; 52, Aug.; 72, Oct.
Election Notices (S.C.M.s).....	60, Feb.; 58, Apr.;
	52, June; 52, Aug.; 72, Oct.
South Carolina Phone Net.....	59, Mar.
20-Year Club.....	64, May
Emergencies (F.E.H.).....	51, Apr.
Band Distribution of Amateurs (F.E.H.).....	59, May
QSA-QRK-Systems (F.E.H.).....	45, June
Hams Afloat.....	51, Aug.
Communications Emergencies (F.E.H.).....	65, Nov.
WIAW Operating Schedule.....	67, Nov.

CONTESTS AND TESTS

First "A.R.R.L." QSO Party—Announcement (F.E.H.).....	10, Jan.
How Would You Do It? (Problem Contest).....	39, Jan.;
	42, Feb.; 50, Mar.; 39, Apr.; 52, May; 47, July; 37, Aug.; 49, Sept.; 52, Oct.; 40, Dec.
Results, October O.R.S.-O.P.S. Parties.....	49, Jan.
South African DX Contest.....	49, Jan.
A.R.R.L.'s Tenth International DX Competi- tion—Announcement (Handy).....	26, Feb.
Navy Day Competition—1937 (E.L.B. and T.W.Y.).....	36, Feb.
1.75-Mc. DX Tests.....	55, Feb.
Canada-U.S.A. Contact Contest.....	10, Mar.
Highlights of the 1938 DX Contest (Goodman)	8, May
Eighth A.R.R.L. Sweepstakes Contest Results (Battley).....	46, May
Hungarian DX Contest.....	66, May
Polish DX Contest.....	66, May
December O.R.S.-O.P.S. Parties.....	56, Apr.
Sixth A.R.R.L. Field Day Contest (F.E.H.).....	33, June
The Fourth A.R.R.L. Copying Bee.....	37, June
April O.R.S.-O.P.S. Parties.....	60, July
Results, First "A.R.R.L." QSO Party (Battley)	39, Aug.
DJDC Contest.....	43, Aug.
The Canada-U.S.A. Contact Contest, 1938 (Saxon).....	25, Sept.
Announcing—The Maxim Memorial (WIAW) Dedication Relay.....	45, Sept. 51, Sept.
VK-ZL Contest.....	66, Oct.
The Maxim Memorial WIAW—Dedication Relay.....	67, Oct.
EI/GI DX Contest.....	42, Nov.
1938 DX Competition Results (Battley).....	
Announcing—Ninth A.R.R.L. Sweepstakes (Handy).....	52, Nov.
July O.R.S.-O.P.S. Parties.....	67, Nov.
A.R.R.L. Field Day Results.....	28, Dec.

CONVENTIONS

Kansas State Convention.....	32, May
New England Division Convention.....	45, May
Hudson Division Convention.....	45, May
Atlantic Division Convention.....	45, May; 19, June
Glacier Park District Convention.....	20, June
West Gulf Division Convention.....	39, July
The A.R.R.L. National Convention.....	17, Aug.; 44, Sept.
Northwestern Division Convention.....	26, Aug.
Maritime Divisional Convention.....	36, Aug.
Delta Division Convention.....	66, Aug.
New Hampshire State Convention.....	90, Aug.
Midwest Division Convention.....	30, Oct.
Rocky Mountain Division Convention.....	110, Sept.
Massachusetts State Convention.....	20, Oct.
Hams Over Chicago!.....	48, Nov.
Joint Pacific and Southwestern Division Con- vention.....	58, Nov.

EDITORIALS

Rumors (A.L.B.)	9, Jan.
Historical Recordings (K.B.W.)	7, Feb.
New QST Editor (K.B.W.)	7, Feb.
Organization in Emergencies (C.B.D.)	9, Mar.
Average Age of Amateurs (C.B.D.)	7, May
Field Day (C.B.D.)	7, June
Handbook in Braille (A.L.B.)	7, Apr.
Television (R.A.H.)	7, July
7-Mc. European Broadcasting (K.B.W.)	7, Aug.
National Convention (K.B.W.)	7, Sept.
Five-Meter DX (R.A.H.)	7, Sept.
Balance (K.B.W.)	9, Oct.
Ross A. Hull (K.B.W.)	7, Nov.; 9, Dec.

EMERGENCY AND RELIEF WORK

QRR Work in Oklahoma	54, Feb.
Susquehanna Emergency Net (Landis)	55, Feb.
Oregon Emergency Service	58, Mar.
Michigan Emergency	60, Mar.
Amateurs Mobilize in Southern California	
Flood Emergency (DeSoto)	8, Apr.
When Emergency Strikes (Handy)	35, Apr.
California Wind Storm	53, Apr.
Oklahomans Repeat Emergency Work (W5CEZ)	57, Apr.
The California Flood (Matney)	35, July
Nebraska Amateurs Serve	64, July
Indiana Emergency Operation	64, July
Flood in Alabama	64, July
Kansas Emergency	51, Aug.
Illinois Tornado and Blizzard (Lipson)	55, Sept.
Emergency Planning	60, Sept.
W2LXY and VR6AY Receive Public Service	
Certificates (B.G.)	20, Oct.
Amateur Radio Bests Triple Catastrophe (DeSoto)	11, Nov.

EXPEDITIONS

Bowdoin-Kent Expedition	48, Jan.; 47, Aug.
CQ WCFT (Eurich)	11, Mar.
Archbold New Guinea Expedition—PK6XX	46, June;
	47, Aug.
CQ de W1OXDA (Foss)	23, July
W1OXDA Sails Again	57, July
Gatti African Expedition—OQ5ZZ	47, Aug.

EXPERIMENTER'S SECTION

January, page 42:	
Regenerative Detector Circuit for Reducing Interference (Dawson)	
Curing Interference with Old-Style B.C. Receiver (Priest)	
46 as a Screen-Grid Pentode (Vitolins)	
S.A. or Audio Oscillator for U.H.F. Transmitters (Morgan)	
Plate-Voltage Control with Combination Transformer (Worrell)	
6L6 Screen Supply (Carr)	
February, page 48:	
Audio Peak Limiter for Speech Amplifiers (Bartlett)	
Regeneration Control (Piesen)	
Inexpensive Crystal Selector Switch (Talley)	
Rhombic Antenna at HH4AS (Sherwood)	
FB7 Receiver Changes (Dugonis)	
Neon Oscillation in Regulated Plate Supplies	
Scratch-Paper Feeder (Castner)	
March, page 52:	
Universal Antenna Coupler (Young)	
Band Checker (Mesh)	
A T.R.F. Stage for the Two-Tube Receiver (Dominquez)	
Junk-Box 160-Meter 'Phone for Local QSO's (Gribben)	
VE2EE's Freqmeter Monitor	
Protection Against Bias Failure (Hunter)	
April, page 41:	
Electrolytic Interrupters for D.C. Districts (Hansen)	
6.3-Volt from 7.5-Volt and 2.5-Volt Windings (Kirchhuber)	
Information on Pulleys for Amateur Antenna Use (Tibbetts)	
Dual Power Supply Using Two Pole Transformers (Priest)	
Use of Modern Superhets for Reception of High-Frequency Bands (Coston, Smith)	
May, page 54:	
Crystal Oscillator Requiring No Tuning Adjustment (Ault)	
Calibration Graphs for Panels (Adams)	
Bread-Pan vs. Bread-Board (Donaldson)	
Shielding the Microphone Plug (Thompson)	
Preventing Voltage Breakdown in 6L6 Oscillators (Ehlinger)	
LC Constants for Intermediate, Broadcast and Amateur Bands (Hesse)	
Switched 6L6G Oscillator for Grid-Plate Crystal and E.C.O. Operation (McCarthy)	

June, page 43:

Bias Supply for R.F. Amplifier (Eggebrecht)	
Useful Kink for Locating Coil Taps	
Enclosed Relay Rack for Amateurs (Saxon)	
Templates for Meter and Socket Holes	
Tube Time Delay Circuit Applied to Remote Transmitter Control (Eubanks)	
Voltage-Breakdown Tests on Power-Supply Components (T.M.F.)	
July, page 52:	
A High-Frequency Exciter of Variable Frequency and High Stability	
Low-Cost Split-Stator Midget Condenser	
A Home-Built Neutralizing Condenser for Large Tubes	
August, page 41:	
Another Device for Obtaining Proper Capacity Ranges on Different Bands (Johnstone)	
Simple Modulation Indicator (Harland)	
Plug and Jacks for Changing from Bandspread to General Coverage (Campbell)	
September, page 46:	
A Simple Gear Drive for Rotary Antennas (Carstarphen)	
Handy Kink for Tuning 5-Meter Auto Antenna (Reinhardt)	
Remote Control of a Protective Relay (Lowrey)	
Bridge Crystal Oscillator Circuit (Neu)	
October, page 60:	
Three-Band Crystal-Controlled Exciter Using One Tube (Lane)	
Receiver as Neutralizing Indicator (Cutting)	
Need More Neutralizing Capacity? (Bell)	
Simplifying the Rotary Antenna Mechanism (Blaho)	
November, page 60:	
Economical Two-Stage Transmitter (Reichenbach)	
Inexpensive Flexible Shaft Coupling (Wilson)	
Simple Noise-Limiter Addition to Receiver (Trowbridge)	
Novel QSL Cards (Gillard)	

FEATURES AND FICTION	
The Strongheart Boys in the Pacific	35, Jan.
"You Said a Mouthful" (Hauck)	30, Apr.
Freshman Marlow (Flippin)	41, Sept.
The C.C.C. Takes to the Air (Haight)	41, Jan.
McNinch Praises Amateur Radio	43, Sept.
The Navy's Strange People	55, Sept.
Amateurs Aid Hughes on World Flight (B.G.)	19, Oct.

FREQUENCY CALIBRATION AND CONTROL	
Standard Frequency Transmission from W9X-AN to be Curtailed	106, Jan.
A C.W. and 'Phone Station Freqmeter-Monitor and Modulometer with Cathode Ray Tube (Leibowitz)	17, June
A New Type of Frequency-Checking Device (Grammer)	21, June
Marker Stations	90, June

HAMDOM			
38, Jan.	51, Mar.	25, June	17, Dec.
Dr. E. C. Woodruff, W8CMP			51, Mar.

I.A.R.U. NEWS	
45, Jan.; 51, Feb.; 55, Mar.; 48, Apr.; 57, May; 40, June; 55, July; 43, Aug.; 51, Sept.; 63, Oct.; 63, Nov.; 43, Dec.	
Countries List	45, Jan.
QSL Bureaus	58, May; 63, Oct.

INTERFERENCE	
Curing Interference with Old-Style B.C. Receiver (Exp. Section)	42, Jan.
R.F. Interference From Power Circuits (Chapman)	49, Mar.
Eliminating B.C.L. Interference	37, Aug.

KEYING	
Grid-Controlled Rectifiers for Amateur H.V. Power Supplies (G.G.)	34, Feb.
High-Voltage Keying Relay	96, June
The Permtron—A New Type of Rectifier With Magnetic Control	42, Sept.
Crystal Oscillator Keying Systems	52, Oct.

METERS AND MEASUREMENTS	
Improving Thermo-Ammeter Construction to Increase Accuracy on Ultra-High Frequencies (Miller)	44, May

An Improved Capacity Bridge (Joffe) 43, July
 What, No Meters? (Suttler) 49, Oct.

New Data on Direction of Wave Propagation (G.G.) 102, Oct.

MISCELLANEOUS

True North from Old Sol (Budlong) 18, Jan.
 A Statement from Hygrade-Sylvania 47, Feb.
 Calibration Graphs for Panels (Exp. Section) 54, May
 Bread-Pan vs. Bread-Board (Exp. Section) 55, May
 LC Constants for Intermediate, Broadcast and Amateur Bands (Exp. Section) 55, May
 Useful Kink for Locating Coil Taps (Exp. Section) 43, June
 Templates for Meter and Socket Holes (Exp. Section) 43, June
 Amateurs Cooperate in Air Mail Celebration (Bennett) 63, July
 New World Globe 90, Aug.
 Intercommunicating Telephone Systems 52, May
 Displaying QSL Cards 42, Feb.
 Building Convenience into the Operating Table (Walker and Cox) 36, Nov.
 Inexpensive Flexible Shaft Coupling (Exp. Section) 60, Nov.
 Novel QSL Cards (Exp. Section) 62, Nov.

MONITORS

A Self-Contained Speech Amplifier, Monitor and Control Unit (Lawrence) 30, May
 A C.W. and 'Phone Station Freqmeter-Monitor and Modulometer with Cathode Ray Tube (Leibowitz) 17, June
 Simple Modulation Indicator (Exp. Section) 41, Aug.
 Transmitter Monitoring Systems 39, Jan.

NAVAL COMMUNICATIONS RESERVE

N.C.S. Notes 47, Nov.
 Navy Day Competition (E.L.B. and T.W.Y.) 36, Feb.
 Navy Day Receiving Competition 64, Oct.

OBITUARY

Silent Keys . . . 30, Jan.; 48, Mar.; 50, Apr.; 56, May; 92, June; 102, July; 99, Sept.; 50, Oct.; 41, Nov.; 10, Dec.
 Ross A. Hull 7, Nov.

OPERATING PRACTICES

Notes on Contest Procedure (Chinn) 48, Jan.
 Does This Mean You (Adams) 56, Feb.
 "I Don't Want QSL from W's" (Tilden) 58, Mar.
 To See Ourselves as Others See Us (Basset) 60, May
 Limit QRM (Girard) 52, Apr.
 A Chance to Help (Woodward) 46, June
 On Building Club Attendance (Nelson) 58, July
 Our Golden Opportunity (Cosier) 46, Aug.
 R Stands for . . . ? (Bouck) 47, Aug.
 Short Calls Get DX! (Feng) 54, Sept.
 "What Do You Talk About?" (Pinard) 68, Oct.
 "Mike" Impressions (Greenleaf) 66, Nov.

OSCILLOSCOPES

A C.W. and 'Phone Station Freqmeter-Monitor and Modulometer with Cathode Ray Tube (Leibowitz) 17, June

POWER AND BIAS SUPPLIES

Plate-Voltage Control with Combination Transformer (Exp. Section) 44, Jan.
 Grid-Controlled Rectifiers for Amateur H.V. Power Supplies (G.G.) 34, Feb.
 Neon Oscillation in Regulated Plate Supplies (Exp. Section) 112, Feb.
 Protection Against Bias Failure (Exp. Section) 54, Mar.
 Electrolytic Interrupters for D.C. Districts (Exp. Section) 41, Apr.
 8.3-Volt from 7.5-Volt and 2.5-Volt Windings (Exp. Section) 42, Apr.
 Dual Power Supply Using Two Pole Transformers (Exp. Section) 42, Apr.
 Bias Supplies for R.F. Amplifiers (Exp. Section) 42, June
 Voltage-Breakdown Tests on Power-Supply Components (Exp. Section) 44, June
 Do's and Don'ts in Power Supplies (Ferrill) 40, July
 Grid-Bias Power Packs (Patterson) 30, Sept.
 The Permatron—A New Type of Rectifier With Magnetic Control 42, Sept.

PROPAGATION AND TRANSMISSION EFFECTS

Future DX and Ionosphere Trends (Grammer) 8, Feb.
 Interpreting 1938's 56-Megacycle DX (Pierce) 23, Sept.
 Characteristics of Sky-Wave Transmission (Selvidge) 32, Oct.

RADIO AND REMOTE CONTROL

New Gear for Radio-Control Systems (R.A.H.) 44, July
 A Versatile Remote-Control Circuit (Hilliard) 37, July
 Tube Time Delay Circuit Applied to Remote Transmitter Control (Exp. Section) 44, June
 Ham Radio and Models (DeSoto) 38, Sept.
 Remote Control of a Protective Relay (Exp. Section) 47, Sept.
 Radio Control of Powered Models (DeSoto) 42, Oct.
 The Philco "Mystery Control" 36, Dec.

RADIOTELEPHONY

Plate Modulation of Screen-Grid Tubes (Dukat) 30, Feb.
 Audio Peak Limiter for Speech Amplifiers (Exp. Section) 48, Feb.
 A Home-Built Velocity Microphone (Gibbs) 32, Mar.
 Speech Versus Sine Waves (Anderson) 35, Mar.
 Junk-Box 160-Meter 'Phone for Local QSO's (Exp. Section) 54, Mar.
 A Self-Contained Speech Amplifier, Monitor and Control Unit (Lawrence) 30, May
 Shielding the Microphone Plug (Exp. Section) 55, May
 Some Practical Aspects of Speech Amplifier Design (Bacon) 12, Apr.
 75-Meter 'Phone Goes Hunting in the Maine Woods (Spencer) 27, June
 A Low-Cost 1.75-Mc. 'Phone Transmitter (Chambers) 13, July
 A Four-Band 75-Watt Output 'Phone-C.W. Transmitter (Sylvester and Briggs) 32, Aug.
 Refinements in Combination Exciters (Ferrill) 36, Oct.
 New Approach to Amateur Transmitter Design (Millen) 24, Mar.
 Low Z for Linearity (Hawkins) 57, Oct.

RECEIVERS—REGENERATIVE

Regenerative Detector Circuit for Reducing Interference (Exp. Section) 42, Jan.
 A Regenerative Receiver with High Audio Selectivity (Gager and Graham) 16, Jan.
 Regeneration Control (Exp. Section) 49, Feb.
 A T.R.F. Stage for the Two-Tube Receiver (Exp. Section) 53, Mar.
 A Simple One-Tube Receiver (Ferrill) 34, June

RECEIVERS—SUPERHETERODYNE

28-Megacycle Preselection (Millen and Bacon) 21, Feb.
 FB7 Receiver Changes (Exp. Section) 110, Feb.
 A Double-Regenerative Superhet (Goodman) 15, Mar.
 The Infinite Rejection Principle Applied to Image Attenuation (Miles and McLaughlin) 20, Mar.
 A 5-, 10- and 20-Meter Converter (Ferrill) 27, May
 DeLuxe Battery-Operated Portable Stations (Waterhouse and Hilgedick) 20, Apr.
 Use of Modern Superhets for Reception of High-Frequency Bands (Exp. Section) 43, Apr.
 The Pentagrid Tube as a Combined Second Detector and Beat-Frequency Oscillator (Whitaker) 30, June
 The 1851 in Communications Receivers 86, June
 More on the 1851 40, Sept.
 A Three-Tube Super for Portable or Emergency Work (Grammer) 8, Aug.
 Preselection Simplified (Ferrill) 11, Sept.
 A Low-Cost Single-Signal Receiver (Grammer) 14, Oct.
 A New Automatic Noise Limiter (Dickert) 19, Nov.
 Combined Beat Oscillator and I.F. Amplifier (Schor) 31, Nov.
 Simple Noise-Limiter Addition to Receiver (Exp. Section) 60, Nov.
 Full-Range Selectivity with 455-Kc. Quartz Crystal Filter (Oram) 33, Dec.

RECEIVING—GENERAL

A Feed-Back Compensator for R.F. Circuits (Talen) 14, Mar.
 Minimizing Receiver Frequency Drift (Mayeda) 21, July
 Plug and Jacks for Changing from Bandsread to General Coverage (Exp. Section) 42, Aug.

TELEVISION

Circuit Elements in Modern Television Reception (Wilder) 31, Jan.
 Sweep Circuit Considerations in the Television Receiver (Wilder) 38, Feb.
 Television Transmissions from Los Angeles 47, Feb.
 A Universal Test Unit for the Study of Television Images (Wilder) 37, Mar.
 The Construction of Television Receivers (Wilder) 23, Apr.; 39, May

Building Television Receivers with Standard Cathode-Ray Tubes (Sherman)
 A Practical Television Receiver for the Amateur (Shumard)

21, Oct.
 21, Dec.

Norfolk Amateurs Prepare for Emergencies (Priest and Turner)
 An Auxiliary Transmitter for 1.7- and 3.5-Mc. Work (Mix)
 A 1.75- to 56-Mc. Crystal-Controlled Low-Power Transmitter (Gordon)
 Economical Two-Stage Transmitter (Exp. Section)
 A Simple Transmitter for Portable or Emergency Work (Goodman)

8, Sept.
 34, Sept.
 38, Nov.
 60, Nov.
 18, Dec.

TRANSMITTING—GENERAL

6L6 Screen Supply (Exp. Section)
 The Harmonic Tank Circuit (Hansen)
 Inexpensive Crystal Selector Switch (Exp. Section)
 A Solution to the Tank Circuit L-C Ratio Problem (Lester)
 Band Checker (Exp. Section)
 Applying Band-Pass Couplers to Amateur Transmitters (DeSoto)
 Vacuum-Type Fixed Condensers for Transmitter Tank Circuits (G.G.)
 Shock-Proofing the Transmitter (Waller)
 A Final Amplifier Tuning-Matching-Coupling System (Seaton)
 Low-Cost Split-Stator Midget Condenser (Exp. Section)
 Enclosed Relay Rack for Amateurs (Exp. Section)
 A Home-Built Neutralizing Condenser for Large Tubes (Exp. Section)
 Midget Clip
 Another Device for Obtaining Proper Capacity Ranges on Different Bands (Exp. Section)
 Receiver as Neutralizing Indicator (Exp. Section)
 Need More Neutralizing Capacity? (Exp. Section)
 Varying Transmitter Tank Coil Inductance
 Band-Switching Suggestions
 Ideas in Transmitter Construction
 Non Short-Circuiting Coil Clips
 Making Connections Between Transmitter Units
 How Much Condenser Spacing? (Ferrill)

44, Jan.
 45, Feb.
 49, Feb.
 47, Mar.
 52, Mar.
 12, May
 26, May
 31, Apr.
 36, June
 53, July
 43, June
 53, July
 54, July
 41, Aug.
 60, Oct.
 61, Oct.
 49, Sept.
 38, June
 39, Apr.
 50, Mar.
 40, Dec.
 37, Dec.

TRANSMITTERS—MEDIUM AND H. P.

A Low-Cost 100-Watt Transmitter (Chambers) 1.75- and 28-Mc. Operation with the Low-cost 100-watt Transmitter
 Compact Construction with High Power (Ferrill)
 Applying Band-Pass Couplers to Amateur Transmitters (DeSoto)
 Intra-Band Quick Frequency Change for Transmitters (Goodman)
 Putting the Harmonic Generator to Work (Reinartz)
 Gang Tuning for the Multi-Stage Transmitter (Mix)
 A 250-Watt Output Crystal-Controlled 28- and 56-Mc. Transmitter (Hass)
 A Four-Band 75-Watt Output 'Phone-C.W. Transmitter (Sylvester and Briggs)
 A Six-Band One-Kilowatt Transmitter (Jennings)
 A Compact 100-Watt Transmitter (Chow)
 A Transmitter of General Utility (Mix)

12, Feb.
 45, Apr.
 27, Mar.
 12, May
 23, May
 15, Apr.
 8, June
 12, Aug.
 32, Aug.
 28, Oct.
 54, Oct.
 32, Nov.

TUBES

A New Transmitting Tube—the 809
 46 as a Screen-Grid Tetrode (Exp. Section)
 New Receiving Power Amplifier Tube (6AC5G)
 More New Tubes: RK-56, 6S7, 6W7G, 6J8G
 Transmitting Tube Manual
 Type 1851 Television Tube
 6K8
 New Glow-Discharge Remote Control Tube
 New 1.4-Volt Receiving Tubes
 "Single-Ended" R.F. Receiving Tubes
 813
 RK63, RK62, RK56, 57, 58, 59, 60

37, Jan.
 43, Jan.
 102, Feb.
 32, May
 47, Apr.
 98, Apr.
 98, Apr.
 96, June
 80, Sept.
 55, Nov.
 57, Nov.
 58, Nov.

TRANSMITTING—CRYSTAL AND E.C.O.

56-Mc. Crystal Control with 28-Mc. Crystals (Wolfskill)
 Crystal Oscillator Requiring No Tuning Adjustment (Exp. Section)
 A Two-Tube E.C.O. (Beveridge)
 Switched 6L6G Oscillator for Grid-Plate Crystal and E.C.O. Operation (Exp. Section)
 An E.C.O. of High Stability and Output (Guimont)
 Correction
 A Stabilized E.C. Oscillator (Scoville)
 A High-Frequency Exciter of Variable Frequency and High Stability (Exp. Section)
 Bridge Crystal Oscillator Circuit (Exp. Section)
 Variable Frequency Control for Transmitters (Griffin)

26, Jan.
 54, May
 28, Aug.
 55, May
 29, Aug.
 109, Oct.
 29, Aug.
 52, July
 88, Sept.
 28, Nov.

ULTRA-HIGH FREQUENCIES—APPARATUS

56-Mc. Crystal Control with 28-Mc. Crystals (Wolfskill)
 S.A. or Audio Oscillator for U.H.F. Transmitters (Exp. Section)
 A Simple 56-Mc. Transmitter with Cathode-Bias Modulation (Geiger and McGrath)
 The Harmonic Tank Circuit (Hansen)
 A Pack Set for 200 and 300 Megacycles (Sigmon)
 A 5-, 10- and 20-Meter Converter (Ferrill)
 A Portable Mobile Crystal-Controlled U.H.F. Transmitter (Fadberg)
 Improving Thermo-Ammer Construction to Increase Accuracy on Ultra-High Frequencies (Miller)
 Modernizing the 56-Mc. Transceiver (Burke and Leas)
 A Crystal-Controlled 5- and 10-Meter Portable (Sylvester and Dillaby)
 A 250-Watt Output Crystal-Controlled 28- and 56-Mc. Transmitter (Hass)

26, Jan.
 43, Jan.
 44, Feb.
 45, Feb.
 40, Mar.
 27, May
 37, May
 44, May
 28, Apr.
 46, Apr.
 12, Aug.

TRANSMITTING—EXCITER UNITS

A Five-Band Exciter with Front-of-Panel Band-Changing (Exner)
 New Approach to Amateur Transmitter Design (Millen)
 A Desk-Type Push-Button Frequency-Control Unit (Rodimon)
 A Simplified Exciter Circuit (Drumeller)
 "Look for Me on . . . Kc." (Tilton and Browning)
 A High-Frequency Exciter of Variable Frequency and High Stability (Exp. Section)
 A Five-Band Switching Exciter with 807 Output (Kinn)
 An Auxiliary Transmitter for 1.7- and 3.5-Mc. Work (Mix)
 Refinements in Combination Exciters (Ferrill)
 Three-Band Crystal-Controlled Exciter Using One Tube (Exp. Section)

14, Jan.
 24, Mar.
 33, May
 42, May
 18, July
 52, July
 14, Sept.
 34, Sept.
 36, Oct.
 60, Oct.

ULTRA-HIGH FREQUENCIES—TESTS AND RESULTS

56-Mc. Tests
 56-Mc. Transatlantic Reception of W1KH
 Try 56-Mc. DX1
 56-Mc. DX1
 56-Mc. Goes on Annual Frolic
 Further Reports on 56-Mc. DX

62, Jan.
 47, Feb.
 54, Feb.
 59, July
 19, Aug.
 21, Sept.

TRANSMITTERS—PORTABLE AND L. P.

The "QSL Forty" (Sutter)
 By-Pass Condenser Needed in "QSL Forty" Circuit Diagram
 Junk-Box 160-Meter 'Phone for Local QSO's (Exp. Section)
 Preventing Voltage Breakdown in 6L6 Oscillators (Exp. Section)
 De Luxe Battery-Operated Portable Stations (Waterhouse and Hilgedick)
 A Crystal-Controlled 5- and 10-Meter Portable (Sylvester and Dillaby)
 75-Meter 'Phone Goes Hunting in the Maine Woods (Spencer)
 A Low-Cost 1.75-Mc. 'Phone Transmitter (Chambers)
 The "QSL Forty" on 14 Mc. (Sutter)

24, Feb.
 48, Mar.
 53, Mar.
 55, May
 20, Apr.
 46, Apr.
 27, June
 13, July
 31, July

WHAT THE LEAGUE IS DOING

24, Jan.; 29, Feb.; 19, Mar.; 18, Apr.; 22, May; 20, June; 26, July; 22, Aug.; 19, Sept.; 26, Dec.
 Election Results, Directors
 Braille Handbook
 Habana
 Cairo
 1938 Board Meets
 Financial Statement
 Circulation Statement
 The Battle of Cairo (Warner and Segal)
 Membership Poll
 Minutes of 1938 Board Meeting
 Exec. Committee Minutes
 Election Notice, Directors
 Cairo and Rome

24, Jan.; 29, Feb.
 22, May
 18, Apr.
 20, June
 32a, June
 27, Oct.
 92, June; 10, Dec.
 9, July
 26, July
 27, July
 27, Aug.
 19, Sept.; 26, Oct.
 20, Sept.

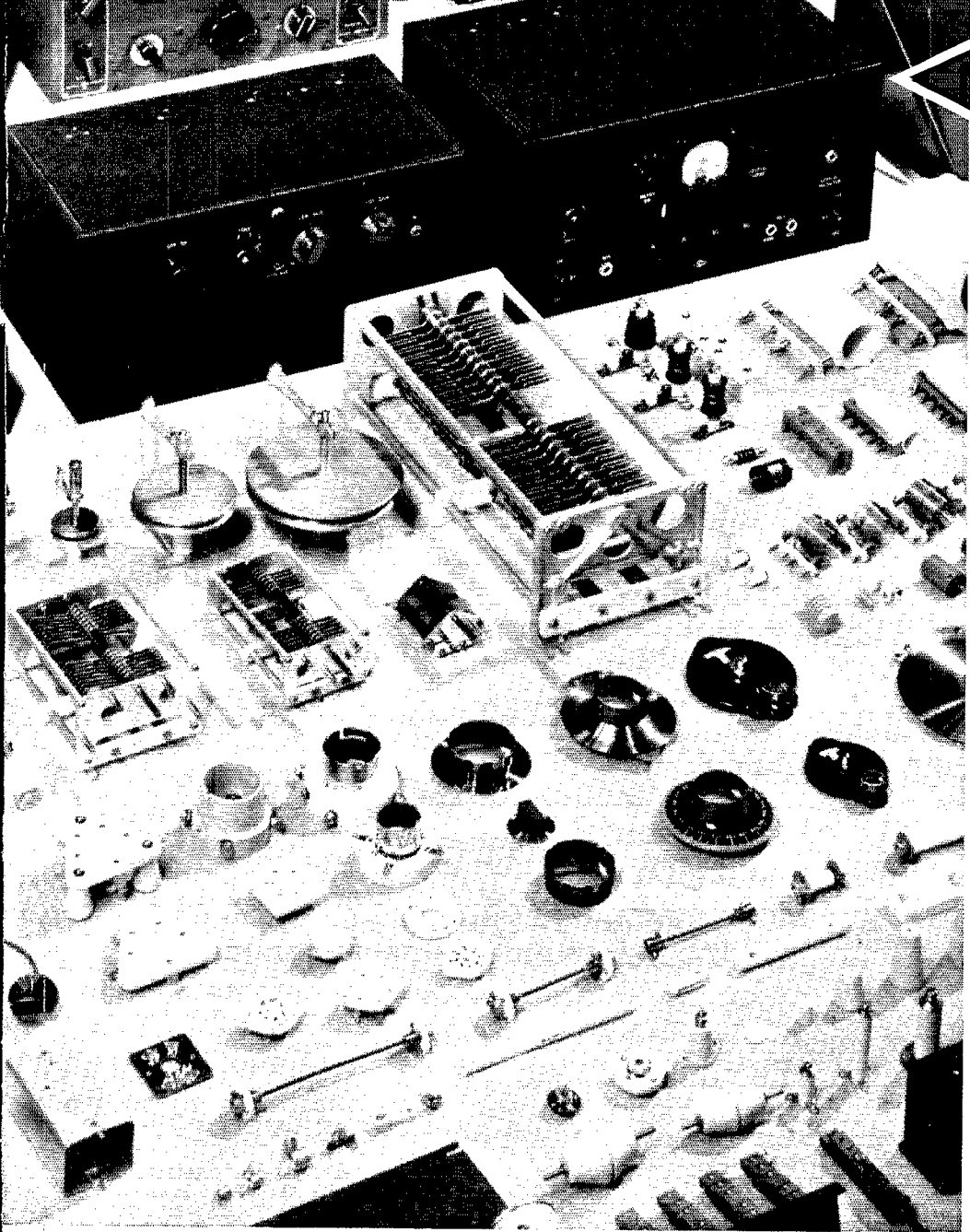

NATIONAL PARTS

National makes a complete line of parts for amateur use, ranging from acorn tube sockets to complete transmitters. Right down the line, every item is designed to meet amateurs' needs dependably, conveniently and at low cost. And equally important, it has the versatility that makes each purchase a long term investment. Look them over at your dealer's.

WANT
HIGH
POWER?



RCA 810
GIVES IT TO YOU AT A
MUCH LOWER
COST!

You Save These 4 Ways!

1. Initial Cost
2. Cost of Tank Circuit Capacitors
3. Cost of Power Supply Equipment
4. Cost of Driver Stage

If high power is what you're after—then here's a new RCA tube that gives it to you at very low cost! Two RCA 810's will take one kilowatt of power at a plate voltage of only 2,000 volts and a driving power of 24 watts.

The RCA 810 is of the high- μ triode type and has unusually high perveance. Features include a

heavy-duty thoriated-tungsten filament, filament shield at each end to prevent stray electrons from escaping and causing bulb heating, and large rugged terminals at the top and side of the bulb. It may be operated at frequencies as high as 30 megacycles at maximum ratings. Price **\$1350**

NEW! RCA Power Tubes now come in the attractive cartons illustrated here. Look for these cartons at your RCA Distributor's!



**MAXIMUM RATINGS—
CLASS "C" TELEGRAPHY**

D-C Plate Voltage	2,000 Volts
D-C Plate Current	250 Milliampères
Plate Input	500 Watts
Plate Dissipation	125 Watts

Listen to the "Magic Key" every Sunday, 2 to 3 P. M., E. S. T., on the NBC Blue Network.

"HAM TIPS" FREE

This new and interesting RCA publication for amateurs is free at all RCA Power Tube Distributors



Radio Tubes